



**Electric Automation**  
Automation specialists

Riferimento: AW 15 31 FT 2L  
Codice: 6420918

Supporto e supporto con fissaggio a 2  
fori, B310mm parete, zincato a caldo,  
DIN EN ISO 1461 Acciaio St

Acquista da [Electric Automation Network](#)

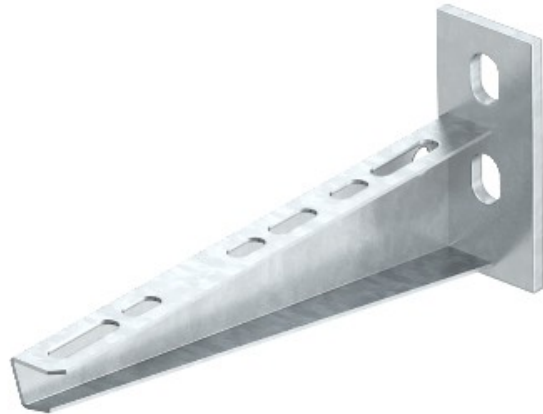

A parete e staffa di supporto con saldato piastra di testa e due fori di fissaggio.