



Electric Automation
Automation specialists

Riferimento: RBM 90 120 FT
Codice: 6041862

Curva 90 °, con connessione veloce,
110x200, zincatura a caldo, DIN EN ISO
1461 Acciaio St

Acquista da [Electric Automation Network](#)

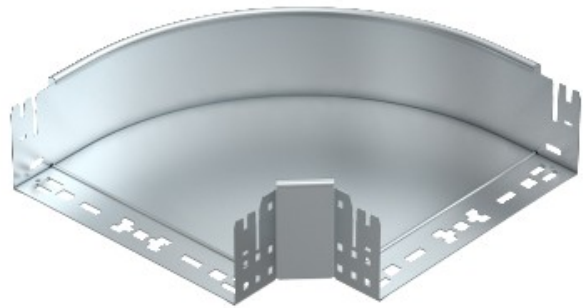

Curva a 90° con attacco rapido del sistema. Per tutti i tipi di supporti per cavi di 110 mm altezza laterale.