



Motorschutzschalter PKZ und PKE

Stillstandszeiten von Maschinen und Anlagen sollen so kurz wie möglich gehalten werden. Die schmelzsicherungslosen Motorschutzschalter PKZ vereinen Kurzschlusschutz und Überlastschutz in einem Gerät. Das ermöglicht eine schnelle Wiedereinschaltbereitschaft. PKZM01, PKZM0, PKZM4 und PKE haben gleiches Zubehör. Einfach kombinierbar mit Schützen DILM und Softstartern DS7. Die Anbindung des PKE an SmartWire-DT ermöglicht hohe Datentransparenz.



Motorschutzschalter PKZM01 (bis 16 A) mit Drucktasten

Motorschutzschalter im Gehäuse für die Schutzarten IP40 und IP65 +++ integrierte NOT-HALT-/NOT-AUS-Schlagtaste reduziert die Verdrahtung.

Motorschutzschalter PKZM0 (bis 32 A) und PKZM4 (bis 65 A) mit Drehknebel

Kurzschlussfest bis mindestens 50 kA für einfache Projektierung +++ Ausgelöstmelder ermöglichen Ferndiagnose +++ hohe Sicherheit durch Einsatz als Hauptschalter oder Reparatur- und Wartungsschalter +++ ATEX-Zulassung für den Schutz von EEx e-Motoren bis 65 A

Motorschutzschalter PKE (bis 65 A) mit elektronischem Weitbereichsüberlastschutz

Hohe Flexibilität durch steckbare Auslöseblöcke +++ weite Stromeinstellbereiche ermöglichen nur fünf Auslöseblöcke bis 65 A +++ präzise und extrem langzeitstabile Auslösekennlinien +++ Eigenversorgung über integrierte Stromwandler +++ ATEX-Zulassung für den Schutz von EEx e-Motoren bis 65 A +++ einstellbare Auslöseklassen

DC-Strangschutzschalter PKZ-SOL und DC-Lasttrennschalter P-SOL (bis 63 A) für Photovoltaikanlagen

Hohe Flexibilität des Strangschutzschalters durch weiten Stromeinstellbereich +++ gekapselter Lasttrennschalter für Außenmontage (IP65) +++ Fernabschaltung durch optionale Unterspannungs- und Arbeitsstromauslöser +++ Spannung bis 1000 V DC +++ TÜV zertifiziert



Motorschutzschalter PKZM01, PKZM0, PKZM4, PKE

Systemübersicht

Motorschutzschalter PKZM01, PKZM0, PKZM4	7/2
--	-----

Bestellen

Motorschutzschalter	7/3
Motorschutzschalter für Starterkombinationen	7/6
Transformatorenschutzschalter	7/6
Elektronischer Motorschutzschalter PKE	7/8
Hilfsschalter	7/12
Hilfsschalter, Spannungsauslöser	7/14

Projektieren

Zusatzrüstung für Motorschutzschalter im Gehäuse	7/16
	7/17

Bestellen

Isolierstoffgehäuse	7/18
Zusatzrüstung	7/22
Sammelschienenadapter	7/24
Verdrahtungssets	7/27
Drehstromschienenblöcke	7/28
Betätigungsspannungen	7/31

Projektieren

Motorschutzschalter	7/32
Kennlinien	7/32
Schaltvermögen	7/35

Technische Daten

Motorschutzschalter	7/40
Hilfsschalter	7/42
Spannungsauslöser	7/42

Abmessungen

Motorschutzschalter PKZM01, PKZM0	7/43
Zusatzrüstung	7/44
Motorschutzschalter PKZM4	7/48
Zusatzrüstung	7/48
Motorschutzschalter PKE	7/51

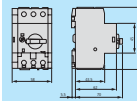
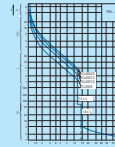
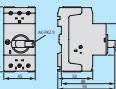
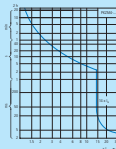
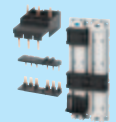

DC-Strangenschutzschalter PKZ-SOL, DC-Lasttrennschalter P-SOL, SOL

Beschreibung

DC-Schalter P-SOL, PKZ-SOL, SOL	7/52
---------------------------------	------

Bestellen

DC-Lasttrennschalter SOL, einbaufertig	7/53
DC-Lasttrennschalter P-SOL, offen	7/54
DC-Strangenschutzschalter PKZ-SOL	7/54

Projektieren

Beschaltung P-SOL, PKZ-SOL Innenschaltung SOL	7/55
Kennlinien	7/56

Technische Daten

DC-Lasttrennschalter P-SOL, SOL	7/57
DC-Strangenschutzschalter PKZ-SOL	7/58

Abmessungen

DC-Schalter P-SOL, PKZ-SOL, SOL	7/59
---------------------------------	------



Systemübersicht

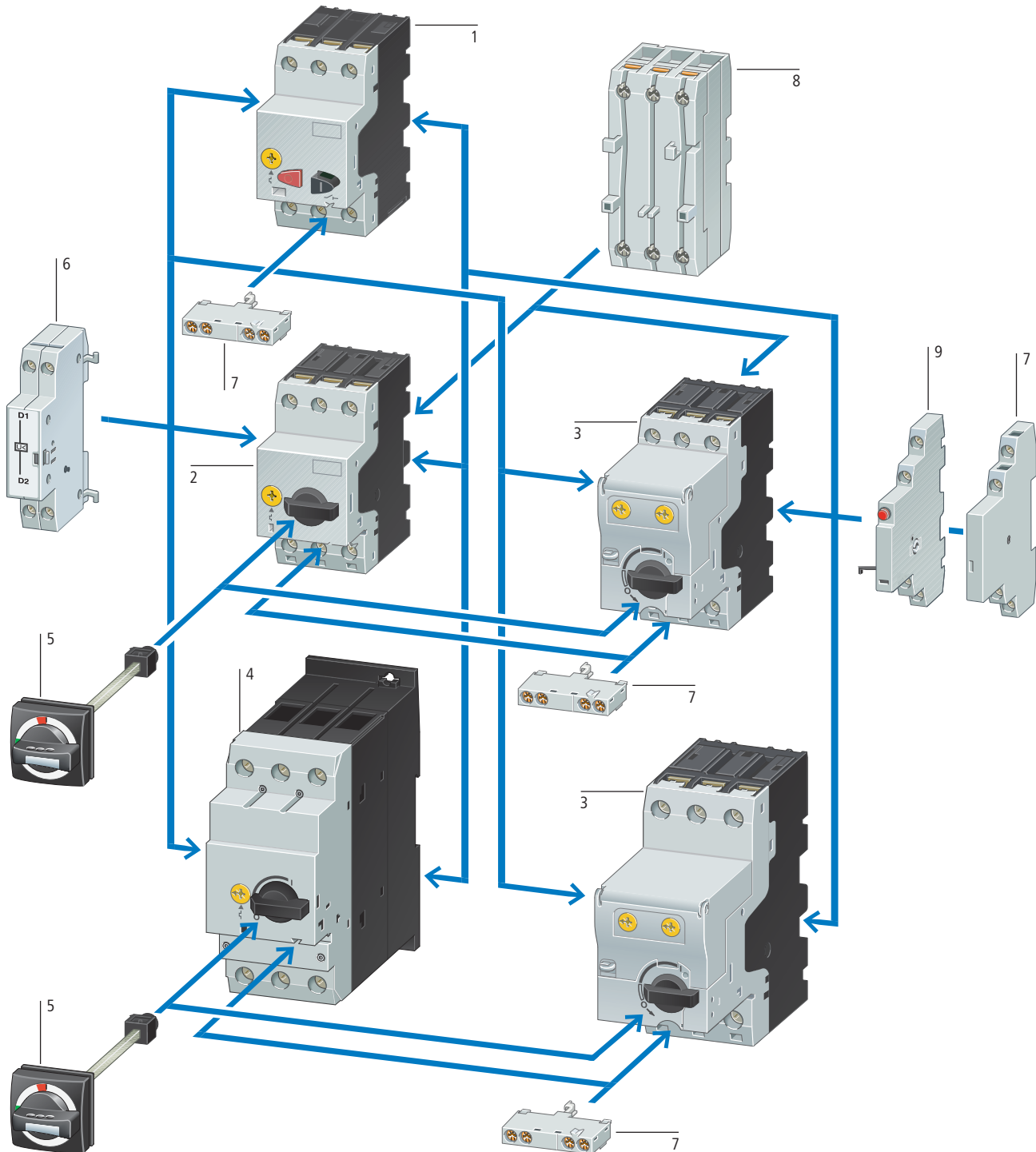

Grundgeräte

Motorschutzschalter PKZM01 1

→ Seite 7/3

Motorschutzschalter PKZM0 2

→ Seite 7/4

Motorschutzschalter mit Weitbereichsüberlastschutz 3

→ Seite 7/8

Motorschutzschalter PKZM4 4

→ Seite 7/4

Funktionszubehör

Normalhilfsschalter 7

→ Seite 7/12

Spannungsauslöser 6

→ Seite 7/14

Strombegrenzer 8

→ Seite 7/14

Montagezubehör

Türkupplungsgriff IP65 5

→ Seite 7/22

Isolierstoffgehäuse

→ Seite 7/18

Montage/Verdrahtung

→ Seite 7/24

Bestellen

max. Bemessungs- betriebsleistung AC-3			Bemes- sungs- dauer- strom	Einstellbereich		Schraubklemmen		VPE	Information relevant for export to North America
220 V	380 V	440 V		Überlast- auslöser	Kurz- schluss- auslöser	Typ	Preis pro Stück		
230 V	400 V		I _n	I _r	I _{rm}	Euro RG			
240 V	415 V								
P	P	P	A	A	A				
kW	kW	kW							

Motorschutzschalter, Zuordnungsart „1“ und „2“										
	-	-	-	0,16	0,1...0,16	2,2	PKZM01-0,16 278475	50,70 50	1 Stück	Product Standards UL 508; CSA-C22.2 No. 14; IEC60947-4-1; CE marking UL File No. E36332 UL CCN NLRV CSA File No. 165628 CSA Class No. 3211-05 NA Certification UL Listed, CSA certified Suitable for Branch circuit, or suitable for group installations See also → Seite 7/34
	-	0,06	0,06	0,25	0,16...0,25	3,5	PKZM01-0,25 278476	50,70 50		
	0,06	0,09	0,12	0,4	0,25...0,4	5,6	PKZM01-0,4 278477	50,70 50		
	0,09	0,12	0,18	0,63	0,4...0,63	8,8	PKZM01-0,63 278478	54,10 50		
	0,12	0,25	0,25	1	0,63...1	14	PKZM01-1 278479	56,10 50		
	0,25	0,55	0,55	1,6	1...1,6	22	PKZM01-1,6 278480	60,60 50		
	0,37	0,75	1,1	2,5	1,6...2,5	35	PKZM01-2,5 278481	60,40 50		
	0,75	1,5	1,5	4	2,5...4	56	PKZM01-4 278482	60,40 50		
	1,1	2,2	3	6,3	4...6,3	88	PKZM01-6,3 278483	60,00 50		
	2,2	4	4	10	6,3...10	140	PKZM01-10 278484	70,20 50		
	3	5,5	5,5	12	8...12	168	PKZM01-12 278485	70,20 50		
	4	7,5	9	16	10...16	224	PKZM01-16 283390	70,20 50		
	5,5	9	11	20	16...20	280	PKZM01-20 283383	75,50 50		
	5,5	12,5	12,5	25	20...25	350	PKZM01-25 288893	89,30 50		

Hinweise

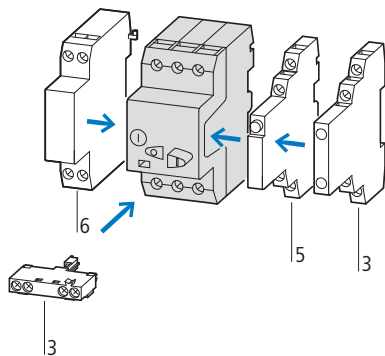

Zusatzrüstung

- 3 Normalhilfsschalter → 7/12
 - 5 Ausgelöstmelder → 7/14
 - 6 Arbeitsstromauslöser, Unterspannungsauslöser → 7/31
- Phasenausfallempfindlichkeit nach IEC/EN 60947-4-1, VDE 0660 Teil 102.
Aufschnappbar auf Hutschiene IEC/EN 60715 mit 7.5 oder 15 mm Höhe.

Seite

- 7/12
- 7/14
- 7/31



Schaltzeichen	max. Bemessungsbetriebsleistung AC-3					Bemessungsdauerstrom	Einstellbereich		Schraubklemmen		Schraubklemmen einspeise-seitig, Federzugklemmen abgangsseitig	
	220 V	380 V	440 V	500 V	660 V		Überlast-auslöser	Kurzschluss-auslöser	Typ Artikel-Nr.	Preis pro Stück	Typ Artikel-Nr.	Preis pro Stück
	230 V	400 V			690 V							
	240 V	415 V										
	P kW	P kW	P kW	P kW	P kW	I_u A	I_r A					
Motorschutzschalter, Zuordnungsart „1“ und „2“¹⁾												
	-	-	-	-	0,06	0,16	0,1...0,16	2,2	PKZM0-0,16 072730	54,50 50	PKZM0-0,16-SC 229828	54,50 50
	-	0,06	0,06	0,06	0,12	0,25	0,16...0,25	3,5	PKZM0-0,25 072731	54,50 50	PKZM0-0,25-SC 229829	54,50 50
	0,06	0,09	0,12	0,12	0,18	0,4	0,25...0,4	5,6	PKZM0-0,4 072732	54,50 50	PKZM0-0,4-SC 229830	54,50 50
	0,09	0,12	0,18	0,25	0,25	0,63	0,4...0,63	8,8	PKZM0-0,63 072733	58,00 50	PKZM0-0,63-SC 229831	58,00 50
	0,12	0,25	0,25	0,37	0,55	1	0,63...1	14	PKZM0-1 072734	60,60 50	PKZM0-1-SC 229832	60,60 50
	0,25	0,55	0,55	0,75	1,1	1,6	1...1,6	22	PKZM0-1,6 072735	65,30 50	PKZM0-1,6-SC 229833	65,30 50
	0,37	0,75	1,1	1,1	1,5	2,5	1,6...2,5	35	PKZM0-2,5 072736	65,00 50	PKZM0-2,5-SC 229834	65,00 50
	0,75	1,5	1,5	2,2	3	4	2,5...4	56	PKZM0-4 072737	65,00 50	PKZM0-4-SC 229835	65,00 50
	1,1	2,2	3	3	4	6,3	4...6,3	88	PKZM0-6,3 072738	64,60 50	PKZM0-6,3-SC 229836	64,60 50
	2,2	4	4	4	7,5	10	6,3...10	140	PKZM0-10 072739	75,60 50	PKZM0-10-SC 229837	75,60 50
	3	5,5	5,5	5,5	11	12	8...12	168	PKZM0-12 278486	75,60 50	PKZM0-12-SC 278487	75,60 50
	4	7,5	9	9	12,5	16	10...16	224	PKZM0-16 046938	75,60 50	PKZM0-16-SC 229838	75,60 50
	5,5	9	11	12,5	15	20	16...20	280	PKZM0-20 046988	81,40 50		
	5,5	12,5	12,5	15	22	25	20...25	350	PKZM0-25 046989	96,30 50		
	7,5	15	15	22	30	32	25...32	448	PKZM0-32 278489	124,00 50		
Motorschutzschalter, Zuordnungsart „1“ und „2“¹⁾												
	4	7,5	9	9	12,5	16	10...16	224	PKZM4-16 222350	132,00 50		
	5,5	12,5	12,5	15	22	25	16...25	350	PKZM4-25 222352	153,00 50		
	7,5	15	17,5	22	22	32	25...32	448	PKZM4-32 222353	165,00 50		
	11	20	22	24	30	40	32...40	560	PKZM4-40 222354	192,00 50		
	14	25	30	30	45	50	40...50	700	PKZM4-50 222355	219,00 50		
	17	30	37	37	55	58	50...58	812	PKZM4-58 222394	229,00 50		
	18,5	34	37	45	55	65	55...65	882	PKZM4-63 222413	231,00 50		
Leistungsschalter²⁾												
zum Schutz von Kabeln und Leitungen												
	-	-	-	-	-	16	10...16	224	PKZM4-16-CB 132591	214,00 50		
	-	-	-	-	-	25	16...25	350	PKZM4-25-CB 132592	233,00 50		
	-	-	-	-	-	32	25...32	448	PKZM4-32-CB 132593	260,00 50		

Typ Artikel-Nr.	Preis pro Stück	VPE	Hinweise	Information relevant for export to North America	
Federzugklemmen					
Typ Artikel-Nr.	Preis pro Stück				
PKZM0-0,16-C 229669	54,50 50				
PKZM0-0,25-C 229670	54,50 50				
PKZM0-0,4-C 229671	54,50 50				
PKZM0-0,63-C 229672	58,00 50				
PKZM0-1-C 229673	60,60 50				
PKZM0-1,6-C 229674	65,30 50				
PKZM0-2,5-C 229675	65,00 50				
PKZM0-4-C 229676	65,00 50				
PKZM0-6,3-C 229677	64,60 50				
PKZM0-10-C 229678	75,60 50				
PKZM0-12-C 278488	75,60 50				
PKZM0-16-C 229679	75,60 50				
<p>1 Stück </p> <p>Zusatzrüstung</p> <ul style="list-style-type: none"> 3 Normalhilfsschalter → 7/12 5 Auslöstmelder → 7/14 6 Arbeitsstromauslöser, Unterspannungsauslöser → 7/31 <p>Phasenausfallempfindlichkeit nach IEC/EN 60947-4-1, VDE 0660 Teil 102 aufschraubbar auf Hutschiene IEC/EN 60715 mit 7.5 oder 15 mm Höhe</p> <p> PTB 10 ATEX 3013, Handbuch MN03402003Z DE/EN beachten → 7/23</p>					
<p>1 Stück </p> <p>Zusatzrüstung</p> <ul style="list-style-type: none"> 3 Normalhilfsschalter → 7/12 5 Auslöstmelder → 7/14 6 Arbeitsstromauslöser, Unterspannungsauslöser → 7/31 <p>Nur Motorschutzschalter:</p> <p>Phasenausfallempfindlichkeit nach IEC/EN 60947-4-1, VDE 0660 Teil 102 aufschraubbar auf Hutschiene IEC/EN 60715 mit 7.5 oder 15 mm Höhe</p> <p> PTB 10 ATEX 3012, Handbuch MN03402008Z DE/EN beachten → 7/23</p>					
<p>1 Stück </p> <p>nicht als Hauptschalter verwendbar</p> <p>Phasenausfallempfindlichkeit nach IEC/EN 60947-4-1, VDE 0660 Teil 102</p> <p>Schaltvermögen SCCR 65 kA (480 Y/277 V) 22 kA (600 Y/347 V)</p> <p>²⁾ Product Standards UL 489; CSA-C22.2 no. 5-09; IEC60947-4-1; CE marking NA Certification Request filed for UL and CSA Specially designed for NA Yes Suitable for Feeder and branch circuit as BCPD</p>					



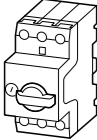
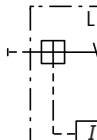
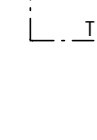

max. Bemessungsbetriebsleistung AC-3					Bemessungs- dauerstrom I_u	Einstellbereich		Schraubklemmen Typ Artikel-Nr.	Preis pro Stück	VPE
220 V	380 V	440 V	500 V	660 V		Überlast- auslöser I_r	Kurzschluss- auslöser I_{rm}			
230 V	400 V			690 V						
240 V	415 V									
P	P	P	P	P	A	A	A			
kW	kW	kW	kW	kW						

Motorschutzschalter für Starterkombinationen

Kurzschlusschutzschalter ohne Überlastfunktion

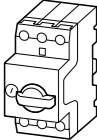
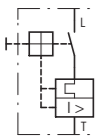
	-	-	-	-	0,06	0,16	-	2,2	PKM0-0,16 072720	52,40 50	1 Stück
	-	0,06	0,06	0,06	0,12	0,25	-	3,5	PKM0-0,25 072721	52,40 50	
	0,06	0,09	0,12	0,12	0,18	0,4	-	5,6	PKM0-0,4 072722	52,40 50	
	0,09	0,12	0,18	0,25	0,25	0,63	-	8,8	PKM0-0,63 072723	55,00 50	
	0,12	0,25	0,25	0,38	0,55	1	-	14	PKM0-1 072724	57,30 50	
	0,25	0,37	0,55	0,75	1,1	1,6	-	22	PKM0-1,6 072725	63,50 50	
	0,37	0,75	1,1	1,1	1,5	2,5	-	35	PKM0-2,5 072726	63,50 50	
	0,75	1,5	1,5	2,2	3	4	-	56	PKM0-4 072727	63,50 50	
	1,1	2,2	3	3	4	6,3	-	88	PKM0-6,3 072728	63,00 50	
	2,2	4	4	4	7,5	10	-	140	PKM0-10 072729	73,20 50	
	3	5,5	5,5	5,5	11	12	-	168	PKM0-12 278490	73,20 50	
	4	7,5	9	9	12,5	16	-	224	PKM0-16 044502	73,20 50	
	5,5	9	11	12,5	15	20	-	280	PKM0-20 203594	77,40 50	
	5,5	12,5	12,5	15	22	25	-	350	PKM0-25 044503	92,00 50	
	7,5	15	15	22	30	32	-	448	PKM0-32 278491	117,00 50	

Transformatorschutzschalter

	-	-	-	-	0,16	0,1...0,16	2,4	PKZM0-0,16-T 088907	54,50 50	1 Stück
	-	-	-	-	0,25	0,16...0,25	4,25	PKZM0-0,25-T 088908	54,50 50	
	-	-	-	-	0,4	0,25...0,4	6,8	PKZM0-0,4-T 088909	54,50 50	
	-	-	-	-	0,63	0,4...0,63	12	PKZM0-0,63-T 088910	58,00 50	
	-	-	-	-	1	0,63...1	20	PKZM0-1-T 088911	60,60 50	
	-	-	-	-	1,6	1...1,6	32	PKZM0-1,6-T 088912	65,30 50	
	-	-	-	-	2,5	1,6...2,5	50	PKZM0-2,5-T 088913	65,00 50	
	-	-	-	-	4	2,5...4	84	PKZM0-4-T 088914	65,00 50	
	-	-	-	-	6,3	4...6,3	141	PKZM0-6,3-T 088915	64,60 50	
	-	-	-	-	10	6,3...10	224	PKZM0-10-T 088916	75,60 50	
	-	-	-	-	12	8...12	224	PKZM0-12-T 278492	75,60 50	
	-	-	-	-	16	10...16	280	PKZM0-16-T 088917	75,60 50	
	-	-	-	-	20	16...20	350	PKZM0-20-T 088918	81,40 50	
	-	-	-	-	25	20...25	437	PKZM0-25-T 278493	96,30 50	

Hinweise

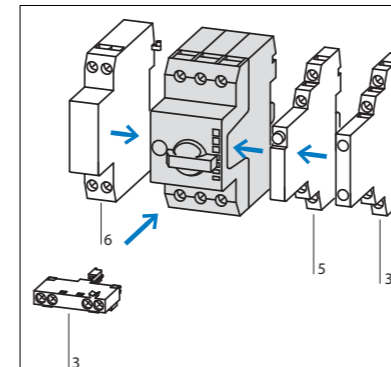

Beim Einsatz des PKM0 als Kurzschlusschutz von schwer anlaufenden Motoren muss der Bemessungsbetriebsstrom I_b bei der Projektierung der Schaltgeräte mit den folgenden Faktoren überdimensioniert werden:
 CLASS 5 = 1.0
 CLASS 10 = 1.0
 CLASS 15 = 1.22
 CLASS 20 = 1.41
 CLASS 25 = 1.58
 CLASS 30 = 1.73
 CLASS 35 = 1.89
 CLASS 40 = 2.0





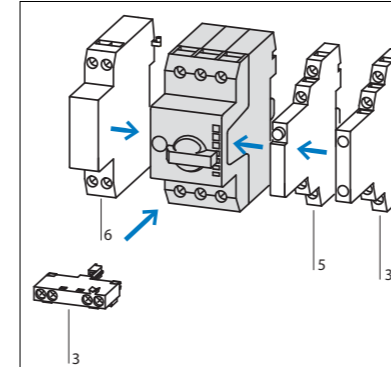



- | | |
|--|--------------|
| Zusatzrüstung | Seite |
| 3 Normalhilfsschalter | → 7/12 |
| 5 Auslöstmelder | → 7/14 |
| 6 Arbeitsstromauslöser, Unterspannungsauslöser | → 7/31 |
| weitere Zusatzrüstung | → 2/46 |





aufschraubbar auf Hutschiene IEC/EN 60715 mit 7,5 oder 15 mm Höhe
 Zuordnung von Kurzschlusschutzschalter und Schütz in Kapitel „Schmelzsicherungslose Motorstarterkombinationen“.
 Zum Überlastschutz von Motoren ist ein entsprechendes Motorschutzrelais vorzusehen.



























- | | |
|--|--------------|
| Zusatzrüstung | Seite |
| 3 Normalhilfsschalter | → 7/12 |
| 5 Auslöstmelder | → 7/14 |
| 6 Arbeitsstromauslöser, Unterspannungsauslöser | → 7/31 |

zum Schutz von Transformatoren mit hohem Einschalttrush
 aufschraubbar auf Hutschiene IEC/EN 60715 mit 7,5 oder 15 mm Höhe
 Phasenausfallempfindlichkeit nach IEC/EN 60947-4-1, VDE 0660 Teil 102

Motorleistung P kW	Motorbemessungsstrom AC-3					Einstellbereich Überlastauslöser I_r A	Grundgerät mit Standardknebel Grundgerät mit abschließbarem Drehknebel AK	Preis pro Stück Euro RG	VPE	verwendbar für
	220 V	380 V	440 V	500 V	660 V					
	230 V	400 V			690 V					
	240 V	415 V								
	I	I	I	I	I					
	A	A	A	A	A					
Zuordnungsart „1“ und „2“										
0,06	0,37	-	-	-	-	0,3 - 1,2	PKE12 121721	36,00 5B	1 Stück  	Grundgerät PKE12
0,09	0,54	0,31	-	-	-		PKE12/AK 158241	38,10 5B		
0,12	0,72	0,41	0,37	0,33	-					
0,18	1,04	0,6	0,54	0,48	0,35					
0,25	-	0,8	0,76	0,7	0,5					
0,37	-	1,1	1,02	0,9	0,7					
0,55	-	-	-	-	0,9					
0,75	-	-	-	-	1,1					
0,18	1,04	-	-	-	-	1 - 4	PKE12 121721	36,00 5B	1 Stück  	Grundgerät PKE12 Grundgerät PKE32
0,25	1,4	-	-	-	-		PKE12/AK 158241	38,10 5B		
0,37	2	1,1	1,02	-	-					
0,55	2,7	1,5	1,39	1,2	-					
0,75	3,2	1,9	1,68	1,5	1,1					
1,1	-	2,6	2,41	2,1	1,5					
1,5	-	3,6	3,28	2,9	2,1					
2,2	-	-	-	4	2,9					
3	-	-	-	-	3,8					
0,75	3,2	-	-	-	-	3 - 12	PKE12 121721	36,00 5B	1 Stück  	Grundgerät PKE12 Grundgerät PKE32
1,1	4,6	-	-	-	-		PKE12/AK 158241	38,10 5B		
0,15	6,3	3,6	3,3	-	-					
2,2	8,7	5	4,6	4	-					
3	11,5	6,6	6	5,3	3,8					
4	-	8,5	7,7	6,8	4,9					
5,5	-	11,3	10,2	9	6,5					
7,5	-	-	-	-	8,8					
2,2	8,7	-	-	-	-	8 - 32	PKE32 121722	47,10 5B	1 Stück  	Grundgerät PKE32
3	11,5	-	-	-	-		PKE32/AK 158245	49,10 5B		
4	14,8	8,5	-	-	-					
5,5	19,6	11,3	10,2	9	-					
7,5	26,4	15,2	13,8	12,1	8,8					
11	-	21,7	19,8	17,4	12,6					
15	-	29,3	26,6	23,4	17					
18,5	-	-	-	28,9	20,9					
22	-	-	-	-	23,8					
30	-	-	-	-	32					

Bemessungsdauerstrom I_u A	Einstellbereich		Grundgerät mit Standardknebel	Preis pro Stück Euro RG	VPE	verwendbar für
	Überlastauslöser I_r A	Kurzschlussauslöser				
						
	A	A				
36	15 - 36	75 - 288	PKE32 121722	47,10 5B	1 Stück  	Grundgerät PKE32



Information relevant for export to North America   → Seite 7/10

Auslöseblock Motorschutz Standard	Preis pro Stück Euro RG	VPE	verwendbar für Anbindung an SmartWire-DT mit PKE-SWD-32 oder PKE-SWD-SP → Seite 1/16	Auslöseblock Motorschutz Erweitert	Preis pro Stück Euro RG	VPE	Komplettgerät mit Standardknebel Komplettgerät mit abschließbarem Drehknebel AK	Preis pro Stück Euro RG	VPE
PKE-XTU-1.2 121723	62,30 5B	1 Stück  	Grundgerät PKE12	PKE-XTUA-1.2 121727	71,60 5B	1 Stück  	PKE12/XTU-1.2 121731 PKE12/AK/XTU-1.2 158242	102,00 5B 102,00 5B	1 Stück  
PKE-XTU-4 121724	62,30 5B	1 Stück  	Grundgerät PKE12 Grundgerät PKE32	PKE-XTUA-4 121728	71,60 5B	1 Stück  	PKE12/XTU-4 121732 PKE12/AK/XTU-4 158244	102,00 5B 102,00 5B	1 Stück  
PKE-XTU-12 121725	62,30 5B	1 Stück  	Grundgerät PKE12 Grundgerät PKE32	PKE-XTUA-12 121729	71,60 5B	1 Stück  	PKE12/XTU-12 121733 PKE12/AK/XTU-12 158243	102,00 5B 102,00 5B	1 Stück  
PKE-XTU-32 121726	76,80 5B	1 Stück  	Grundgerät PKE32	PKE-XTUA-32 121730	88,40 5B	1 Stück  	PKE32/XTU-32 121734 PKE32/AK/XTU-32 158246	128,00 5B 128,00 5B	1 Stück  

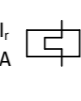
Auslöseblock Anlagenschutz Standard	Preis pro Stück Euro RG	VPE	verwendbar für Anbindung an SmartWire-DT mit PKE-SWD-32 oder PKE-SWD-SP	Auslöseblock Anlagenschutz Erweitert	Preis pro Stück Euro RG	VPE	Komplettgerät mit Standardknebel	Preis pro Stück Euro RG	VPE
PKE-XTUCP-36 153164	80,70 5B	1 Stück	Grundgerät PKE32	PKE-XTUACP-36 168795	89,20 50	1 Stück	PKE32/XTUCP-36 168972	a. A. 5B	1 Stück

Motorleistung P kW	Motorbemessungsstrom AC-3					Einstellbereich Überlastauslöser I_r A		Grundgerät mit Standardknebel Grundgerät mit abschließbarem Drehknebel AK	Typ Artikel-Nr.	Preis pro Stück	VPE	verwendbar für
	220 V	380 V	440 V	500 V	660 V							
	230 V	400 V			690 V							
	240 V	415 V										

Zuordnungsart „1“ und „2“

5,5	19,6	-	-	-	-	16 - 65	PKE65 138258	109,00 5B	1 Stück		Grundgerät PKE65
7,5	26,4	-	-	-	-						
11	38	21,7	19,7	17,4	-						
15	51	29,3	26,6	23,4	17						
18,5	63	36	32,9	28,9	20,9						
22	-	41	37,4	33	23,8						
30	-	55	50,3	44	32						
37	-	-	61,4	54	39						
45	-	-	-	65	47						
55	-	-	-	-	58						
2,2	8,7	-	-	-	-	8 - 32	PKE65 138258	109,00 5B	1 Stück		Grundgerät PKE65
3	11,5	-	-	-	-						
4	14,8	8,5	-	-	-						
5,5	19,6	11,3	10,2	9	-						
7,5	26,4	15,2	13,8	12,1	8,8						
11	-	21,7	19,8	17,4	12,6						
15	-	29,3	26,6	23,4	17						
18,5	-	-	-	28,9	20,9						
22	-	-	-	-	23,8						
30	-	-	-	-	32						



Bemessungsdauerstrom I_u A	Einstellbereich		Grundgerät mit Standardknebel	Typ Artikel-Nr.	Preis pro Stück	VPE	verwendbar für
	Überlastauslöser I_r A	Kurzschlussauslöser I_{im} A					
	15 - 36	75 - 288					
	30 - 65	150 - 520					

Information relevant for export to North America

	UL508; CSA-C22.2 No.14; IEC60947-4-1; CE marking
Product Standards	E36332
UL File No.	NLRV
UL CCN	165628
CSA File No.	3211-05
CSA Class No.	UL listed, CSA certified
NA Certification	

Auslöseblock Motorschutz Standard	Typ Artikel-Nr.	Preis pro Stück	VPE	verwendbar für Anbindung an SmartWire-DT mit PKE-SWD-SP → Seite 1/16	Auslöseblock Motorschutz Erweitert		Typ Artikel-Nr.	Preis pro Stück	VPE	Komplettgerät mit Standardknebel Komplettgerät mit abschließbarem Drehknebel AK	Typ Artikel-Nr.	Preis pro Stück	VPE











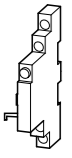
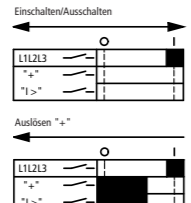

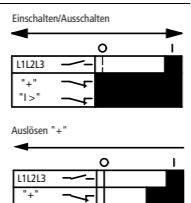

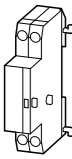

PKE-XTU-65 138259	106,00 5B	1 Stück		Grundgerät PKE65	PKE-XTUA-65 138260	124,00 5B	1 Stück		PKE65/XTU-65 138516	213,00 5B	1 Stück	
PKE-XTUW-32 138261	99,60 5B	1 Stück		Grundgerät PKE65	PKE-XTUWA-32 138262	114,00 5B	1 Stück		PKE65/XTUW-32 138517	207,00 5B	1 Stück	

Auslöseblock Anlagenschutz Standard	Typ Artikel-Nr.	Preis pro Stück	VPE	verwendbar für Anbindung an SmartWire-DT mit PKE-SWD-SP	Auslöseblock Anlagenschutz Erweitert	Typ Artikel-Nr.	Preis pro Stück	VPE	Komplettgerät mit Standardknebel	Typ Artikel-Nr.	Preis pro Stück	VPE
PKE-XTUWCP-36 168796	105,00 50	1 Stück		Grundgerät PKE65	PKE-XTUWACP-36 168797	121,00 50	1 Stück		PKE65/XTUWCP-36 168973	a. A. 5B	1 Stück	

Kontaktbestückung S = Schließer Ö = Öffner	Kontaktdiagramm	Schaltzeichen	Anschluss- technik	verwend- bar für	Typ Artikel-Nr.	Preis pro Stück Euro RG	VPE
1 S	1 Ö		Schraub- klemmen	PKZM01 PKZM0 PKZM4 PKZM0-T PKM0 PKE ¹⁾	NHI11-PKZO 072896	9,70 50	5 Stück
1 S	1 Ö		Federzug- klemmen		NHI11-PKZO-C 229680	9,70 50	
1 S	2 Ö		Schraub- klemmen		NHI12-PKZO 072895	15,60 50	
2 S	1 Ö		Schraub- klemmen		NHI21-PKZO 072894	15,60 50	
1 S	1 Ö		Schraub- klemmen		NHI-E-11-PKZO 082882	9,60 50	
1 S	-		Schraub- klemmen		NHI-E-10-PKZO 082884	7,40 50	
1 S	-		Federzug- klemmen		NHI-E-10-PKZO-C 229681	7,40 50	
-	1 Ö		Federzug- klemmen		NHI-E-01-PKZO-C 229682	7,40 50	5 Stück
1 S	1 Ö		Schraub- klemmen		NHI-B-11-PKZO 208277	9,65 50	5 Stück

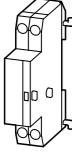
Hinweise ¹⁾ Nur Normalhilfsschalter ab Fertigung KW 36/2009 für PKE verwendbar.

Hinweise	Hinweise	Information relevant for export to North America
<p>rechtsseitig anbaubar an: Motorschutzschalter, Transformatorschutzschalter, Motorschutzschalter für Starterkombinationen</p> <p>kombinierbar mit: Ausgelöstmelder AGM, NHI-E-...</p>		<p></p> <p>Product Standards UL File No. E36332 UL CCN NLRV CSA File No. 165628 CSA Class No. 3211-05 NA Certification UL Listed, CSA certified</p>
<p>Anbaubar an Motorschutzschalter, Transformatorschutzschalter, Motorschutzschalter für Starterkombinationen ab Serien-Nr. 01. 45 mm (PKZM0 und PKZM01) bzw. 55 mm (PKZM4) Baubreite des Motorschutzschalters bleibt erhalten. NHI-E...-PKZO-C nicht für Motorstarterkombinationen Typ MSC... verwendbar.</p>	<p>Zusatz-ausrüstung</p> <p>1 Motorschutzschalter → 7/4 5 Ausgelöstmelder → 7/14 weitere Zusatz-ausrüstung → 7/22</p>	

Kontaktbestückung S = Schließer Ö = Öffner	Kontaktdiagramm	Schaltzeichen	verwendbar für	Typ Artikel-Nr.	Preis pro Stück Euro RG	VPE	
Ausgelöstmelder							
für Motorschutzschalter							
	2 x 1 S	—		PKZM0 PKZM4 PKZM0-T PKM0 PKZM01 PKE ¹⁾	AGM2-10-PKZ0 072898	16,90 50	2 Stück 
	—	2 x 1 Ö		PKZM0 PKZM4 PKZM0-T PKM0 PKZM01 PKE ¹⁾	AGM2-01-PKZ0 072899	16,90 50	2 Stück 
Voreilender Hilfsschalter							
für Motorschutzschalter							
	2 S	—	—	PKZM0 PKZM4 PKM0 PKZM4	VHI20-PKZ0 203595	12,00 50	2 Stück 
	2 S	—	—	PKZM01	VHI20-PKZ01 278495	11,80 50	5 Stück 
Arbeitsstromauslöser							
	—	—	—	PKZM0 PKZM4 PKZM0-T PKM0 PKZM01 PKE ²⁾	A-PKZ0(230V50HZ) 073187	29,50 50	2 Stück 
	—	—	—	PKZM0 PKZM4 PKZM0-T PKM0 PKZM01 PKE ²⁾	A-PKZ0(24VDC) 073200	37,20 50	2 Stück 
Unterspannungsauslöser							
	—	—	—	PKZM0 PKZM4 PKZM0-T PKM0 PKZM01 PKE ²⁾	U-PKZ0(230V50HZ) 073135	29,50 50	2 Stück 
Strombegrenzer							
zur Erhöhung des Schaltvermögens nicht eigenfester Motorschutzschalter							
	—	—	—	PKZM0 PKZM4 PKE	CL-PKZ0 082881	40,40 50	1 Stück 

Hinweise
¹⁾ Nur AGM2-...-PKZ0 ab Fertigung 06/2009 anbaubar.
²⁾ Nur A(U)-PKZ0... ab Seriennummer 02 anbaubar.

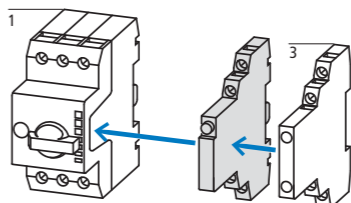
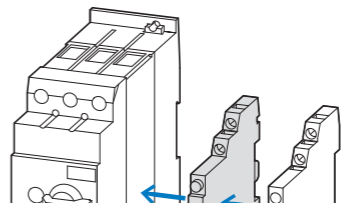
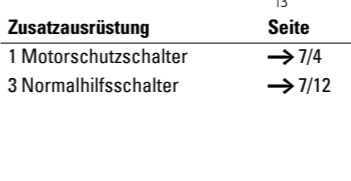
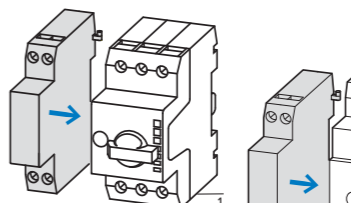
Hinweise	Hinweise	Information relevant for export to North America
		
rechtsseitig anbaubar an Motorschutzschalter		Product Standards UL 508; CSA-C22.2 No. 14; IEC60947-4-1; CE marking
kombinierbar mit: Normalhilfsschalter NHI11-PKZ0 NHI12-PKZ0 NHI21-PKZ0 NHI-E-...		UL File No. E36332 UL CCN NLRV CSA File No. 165628 CSA Class No. 3211-05 NA Certification UL Listed, CSA certified
differenzierte Signalisierung: a) allgemeine Auslöstmeldung (Überlast) b) Kurzschlussauslösung		
Kurzschlussignalisation vor Ort durch roten Indikator, rücksetzbar von Hand		
Frontseitig anbaubar an Motorschutzschalter, 45 mm Baubreite des Motorschutzschalters bleibt erhalten. Zum vorzeitigen an Spannung legen des U-Auslösers, z. B. in NOT-AUS-Kreisen nach EN 60204. VHI20-PKZ0 nicht in Kombination mit PKZ0-X(R) verwendbar.		
	Zusatzrüstung 1 Motorschutzschalter 3 Normalhilfsschalter	Seite → 7/4 → 7/12
linksseitig anbaubar an: Motorschutzschalter nicht kombinierbar mit: Unterspannungsauslöser U-PKZ0 DC: Kurzzeitbetrieb 5 s		
	Zusatzrüstung 1 Motorschutzschalter weitere Betätigungsspannungen	Seite → 7/4 → 7/31
max. Bemessungsbetriebsspannung $U_e = 690$ V, Bemessungsdauerstrom $I_n = 63$ A Für Einzel- und Gruppenschutz. Für Gruppenschutz und in Kombination mit PKZM4 gegebenenfalls zusätzlich Einspeiseklemme BK25/ 3 bestellen. Montage neben und hinter Motorschutzschalter. PKZM4: 16 - 63 A: 100 kA/400 V PKZM4: 16 - 63 A: 10 kA/690 V		

Projektieren

Gehäuse		Zusatzausrüstung									
Typ	Typ	Schutzart	Grifffarbe	NHI..-PKZ0	AGM2-..-PKZ0	NHI-E.-PKZ0	VHI..-PKZ0	VHI..-PKZ01	U-PKZ0 oder A-PKZ0	L-PKZ0	
Aufbaugeschäfte											
Motorschutzschalter PKZM01											
	CI-PKZ01	IP40	–	–	–	●	–	–	●	●	
	CI-PKZ01-G	IP65	–	–	–	–	–	●	●	●	
				●	–	●	–	–	●	●	
				●	–	–	●	–	–	●	●
	CI-PKZ01-PVT CI-PKZ01-PVS	IP65	rot-gelb	–	–	●	–	–	●	●	
–				–	–	–	●	●	●		
	CI-PKZ01-SVB	IP65	–	–	–	●	–	–	●	●	
	CI-PKZ01-SVB-V	IP65	–	–	–	–	–	● ¹⁾	●	●	
Motorschutzschalter PKZM0											
	CI-K2-PKZ0	IP41	–	●	–	●	–	–	●	●	
				–	●	●	–	–	●	●	
	CI-K2-PKZ0-G	IP65	schwarz	●	–	●	–	–	●	●	
				–	●	●	–	–	●	●	
	CI-K2-PKZ0-GR	IP65	rot-gelb	●	–	●	–	–	●	●	
				–	●	●	–	–	●	●	
		CI-PKZ0-M	IP40	–	●	–	●	–	–	●	●
					–	–	●	–	–	●	●
	CI-PKZ0-GM	IP55	schwarz	●	–	●	–	–	–	●	
	CI-PKZ0-GRM	IP55	rot-gelb	●	–	●	–	–	●	●	
	CI-K2-PKZ0-GV	IP65	schwarz	●	–	–	●	–	●	●	
				–	●	–	●	–	●	●	
	CI-K2-PKZ0-GRV	IP65	rot-gelb	●	–	–	●	–	●	●	
				–	●	–	●	–	●	●	
		CI-K2-PKZ0-GVM	IP55	schwarz	●	–	–	●	–	–	●
CI-K2-PKZ0-GRVM		IP55	rot-gelb	●	–	–	●	–	–	●	

Hinweise

Die Kombinationsmöglichkeiten von Schutzschaltern im Gehäuse mit Zubehörbausteinen sind durch ● gekennzeichnet.
¹⁾ immer erforderlich



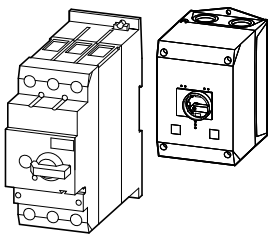
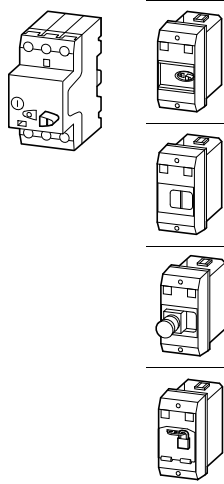
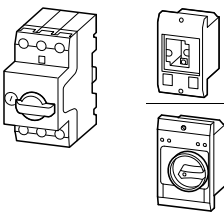







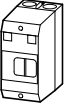

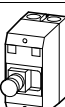
PKZM4, PKZM01, PKZM0

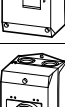



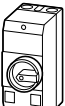

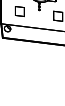













Gehäuse				Zusatzrüstung						
Typ	Typ	Schutzart	Griff-farbe	NHI...-PKZ0	AGM2...-PKZ0	NHI-E...-PKZ0	VHI...-PKZ0	VHI...-PKZ01	U-PKZ0 oder A-PKZ0	L-PKZ0
Aufbaugeschäfte										
Motorschutzschalter PKZM4										
	CI-K4-PKZ4-G	IP65	schwarz	●	●	●	-	-	●	●
	CI-K4-PKZ4-GR	IP65	rot-gelb	●	●	●	-	-	●	●
				●	●	-	●	-	●	●
				●	●	-	●	-	●	●
Einbaugeschäfte										
Motorschutzschalter PKZM01										
	E-PKZ01	IP40	-	-	-	●	-	-	●	●
				-	-	-	-	●	●	●
				●	-	●	-	-	-	●
	E-PKZ01-G	IP65	-	-	-	●	-	-	●	●
				-	-	-	-	●	●	●
				●	-	●	-	-	-	●
	E-PKZ01-PVT E-PKZ01-PVS	IP65	rot-gelb	-	-	●	-	-	●	●
				-	-	-	-	●	●	●
	E-PKZ01-SVB	IP65	-	-	-	●	-	-	●	●
	E-PKZ01-SVB-V	IP65	-	-	-	-	-	● ¹⁾	●	●
Motorschutzschalter PKZM0										
	E-PKZ0	IP40	-	●	-	-	-	-	-	●
				-	-	-	-	-	●	●
	E-PKZ0-G	IP55	schwarz	●	-	●	-	-	-	●
				-	-	●	-	-	●	●
	E-PKZ1-GR	IP55	rot-gelb	●	-	●	-	-	-	●
			-	-	●	-	-	●	●	

Hinweise

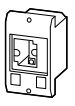











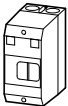





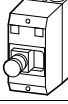

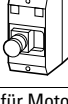
Die Kombinationsmöglichkeiten von Schutzschaltern im Gehäuse mit Zubehörbausteinen sind durch ● gekennzeichnet.
¹⁾ immer erforderlich













	Schutzart	verwendbar für	Typ Artikel-Nr.	Preis pro Stück Euro RG	VPE	Hinweise	
Isolierstoffgehäuse für den Aufbau							
für Motorschutzschalter PKZM01							
	–	IP40	PKZM01 +NHI-E oder VHI-PKZ01 +U oder A oder NHI +L (2 Stück)	CI-PKZ01 281403	12,80 50	1 Stück integrierte Klemme für PE(N)-Anschluss, oben und unten je 2 Leitungseinführungen M25 vorgeprägt.	
	mit Betätigungsmembran	IP65		CI-PKZ01-G 281404	18,10 50		
	abschließbar in Nullstellung	IP65	PKZM01 +NHI-E oder +U oder A +L (2 Stück)	CI-PKZ01-SVB 281405	25,20 50		
	abschließbar in Nullstellung, in Kombination mit VHI-PKZ01	IP65		CI-PKZ01-SVB-V 281944	25,20 50		
	mit NOT-AUS-Piltaster rastend	IP65		CI-PKZ01-PVT 281406	38,50 50		
	mit NOT-AUS-Piltaster mit Schlüsselentriegelung	IP65		CI-PKZ01-PVS 281407	61,90 50		
	Zur Ergänzung mit Einsätzen CI/E-PKZ01-X...	wie Einsatz	PKZM01	CI-PKZ01-X 289934	11,20 50		
für Motorschutzschalter PKZM0							
	Deckel mit Aussparung im Kapfenmaß. IP40, wenn um 90° links/rechts gekippt	IP41 bei senk- rechter Montage	PKZM0-... +NHI oder AGM +U oder A +NHI-E +L-PKZ0 (2 Stück)	CI-K2-PKZ0 219653	12,20 50	1 Stück Metrische Vorprägung oben und unten M25 Leitungsdurchsteckmembran oben, unten, in der Rückwand und als Steuerleitungseinführung. Isolierstoffgehäuse CI-K2 inkl. N- und PE-Klemme.	
	mit schwarz-grauem Drehgriff	IP65		CI-K2-PKZ0-G 219654	14,10 50		
	mit rot-gelbem Drehgriff zur Verwendung als NOT-AUS-Schalter nach EN 60204	IP65		CI-K2-PKZ0-GR 219655	18,60 50		
	Deckel mit Aussparung im Kapfenmaß	IP40	PKZM0-... +NHI oder U oder A +L-PKZ0 (2 Stück)	CI-PKZ0-M 267083	12,50 50		integrierte Klemme für PE(N)-Anschluss, oben und unten je 2 Leitungseinführungen M25 vorgeprägt.
	mit schwarz-grauem Drehgriff	IP55	PKZM0-... +NHI-E +NHI oder U oder A +L-PKZ0 (2 Stück)	CI-PKZ0-GM 260089	14,70 50		
	mit rot-gelbem Drehgriff zur Verwendung als NOT-AUS-Schalter nach EN 60204	IP55		CI-PKZ0-GRM 260104	19,50 50		
für Motorschutzschalter PKZM0 mit voreilendem Hilfsschalter VHI							
	mit schwarz-grauem Drehgriff	IP65	PKZM0-... und VHI +NHI oder AGM +U oder A +L (2 Stück)	CI-K2-PKZ0-GV 219657	14,10 50	1 Stück Metrische Vorprägung oben und unten M25 Leitungsdurchsteckmembran oben, unten, in der Rückwand und als Steuerleitungseinführung. Isolierstoffgehäuse CI-K2 inkl. N- und PE-Klemme.	
	mit rot-gelbem Drehgriff zur Verwendung als NOT-AUS-Schalter nach EN 60204	IP65		CI-K2-PKZ0-GRV 219656	18,60 50		
	mit schwarz-grauem Drehgriff	IP55		PKZM0-... und VHI + U oder A +L-PKZ0 (2 Stück)	CI-PKZ0-GVM 263526		14,30 50
	mit rot-gelbem Drehgriff zur Verwendung als NOT-AUS-Schalter nach EN 60204	IP55	CI-PKZ0-GRVM 263525		18,80 50		
für Motorschutzschalter PKZM4							
	mit schwarz-grauem Drehgriff	IP65	PKZM4-... +VHI oder NHI-E +NHI und AGM +U oder A +L-PKZ0 (2 Stück)	CI-K4-PKZ4-G 225524	43,80 50	1 Stück Metrische Vorprägung: oben und unten: M25/M32 in der Rückwand: M25/M32 Steuerleitungseinführung: M20 Isolierstoffgehäuse CI-K4 inkl. isolierter PE-Klemme	
	mit rot-gelbem Drehgriff zur Verwendung als NOT-AUS-Schalter nach EN 60204	IP65		CI-K4-PKZ4-GR 225525	48,40 50		



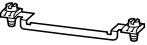





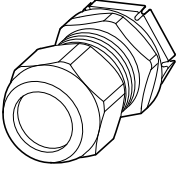
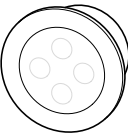

	Schutzart	verwendbar für	Typ Artikel-Nr.	Preis pro Stück Euro RG	VPE	Information relevant for export to North America 
Isolierstoffgehäuse für den Einbau						
für Motorschutzschalter PKZM01 Integrierte Klemme für PE(N)-Anschluss.						
	Front IP40	PKZM01 + NHI oder U oder A +NHI-E oder VHI +L (2 Stück)	E-PKZ01 281633	11,40 50	1 Stück 	Product Standards UL 508; CSA-C22.2 No. 14; IEC60947- 4-1; CE marking E36332 NLRV 165628 3211-05 UL Listed, CSA certified UL File No. UL CCN CSA File No. CSA Class No. NA Certification
	mit Betätigungs- membran Front IP65		E-PKZ01-G 281634	16,60 50	1 Stück 	
	abschließbar in Null- stellung Front IP65	PKZM01 +U oder A +NHI-E	E-PKZ01-SVB 281635	23,80 50	1 Stück 	
	abschließbar in Null- stellung, in Kombina- tion mit VHI-PKZ01 Front IP65	PKZM01 +U oder A +NHI-E oder VHI	E-PKZ01-SVB-V 281943	23,80 50	1 Stück 	
	mit NOT-AUS-Pilz- taster rastend Front IP65		E-PKZ01-PVT 281636	37,00 50	1 Stück 	
	mit NOT-AUS-Pilz- taster mit Schlüssel- entriegelung Front IP65		E-PKZ01-PVS 281637	60,50 50	1 Stück 	
	Zur Ergänzung mit Einsätzen CI/E- PKZ01-X... wie Einsatz	PKZM01	E-PKZ01-X 289935	9,95 50	1 Stück	
für Motorschutzschalter PKZM0 integrierte Klemme für PE(N)-Anschluss.						
	Deckel mit Ausspa- rung im Kapfenmaß Front IP40	PKZM0-... +NHI oder U oder A +L- PKZ0 (2 Stück)	E-PKZ0 072906	11,00 50	1 Stück 	Product Standards UL 508; CSA-C22.2 No. 14; IEC60947- 4-1; CE marking E36332 NLRV 165628 3211-05 UL Listed, CSA certified UL File No. UL CCN CSA File No. CSA Class No. NA Certification
	mit schwarz-grauem Drehgriff Front IP55	PKZM0-... +NHI oder U oder A +NHI-E +L-PKZ0 (2 Stück)	E-PKZ0-G 072907	16,90 50	1 Stück 	
	mit rot-gelbem Dreh- griff zur Verwendung als NOT-AUS-Schal- ter nach EN 60204 Front IP55		E-PKZ0-GR 072908	17,70 50	1 Stück 	Product Standards UL 508; CSA-C22.2 No. 14; IEC60947- 4-1; CE marking E36332 NLRV 165628 3211-05 UL Listed, CSA certified UL File No. UL CCN CSA File No. CSA Class No. NA Certification Degree of Protection IEC: Front IP55, UL/CSA Type: 1, 12, 3R

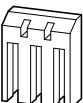

	Schutzart	verwendbar für	Typ Artikel-Nr.	Preis pro Stück Euro RG	VPE	Information relevant for export to North America 	
Isolierstoffgehäuse für den Aufbau							
für Motorschutzschalter PKZM01 integrierte Klemme für PE(N)-Anschluss							
	IP41	PKZM01 +NHI-E oder VHI-PKZ01 +U oder A oder NHI +L (2 Stück)	CI-PKZ01-NA 281408	21,00 50	1 Stück 	Product Standards UL 508; CSA-C22.2 No. 14; IEC60947-4-1; CE marking UL File No. E36332 UL CCN NLRV CSA File No. 165628 CSA Class No. 3211-05 NA Certification UL Listed, CSA certified Specially designed for NA ✓ Degree of Protection IEC: IP41, UL/CSA Type: -	
	mit Betätigungs- membran	IP65	PKZM01 +NHI-E oder VHI-PKZ01 +U oder A oder NHI +L (2 Stück)	CI-PKZ01-NA-G 281409	26,20 50	1 Stück 	Product Standards UL 508; CSA-C22.2 No. 14; IEC60947-4-1; CE marking UL File No. E36332 UL CCN NLRV CSA File No. 165628 CSA Class No. 3211-05 NA Certification UL Listed, CSA certified Specially designed for NA ✓ Degree of Protection IEC: IP65, UL/CSA Type: -
	abschließbar in Null- stellung	IP65	PKZM01 +NHI-E oder VHI-PKZ01 +U oder A +L (2 Stück)	CI-PKZ01-NA-SVB 281630	33,00 50	1 Stück 	Product Standards UL 508; CSA-C22.2 No. 14; IEC60947-4-1; CE marking UL File No. E36332 UL CCN NLRV CSA File No. 165628 CSA Class No. 3211-05 NA Certification UL Listed, CSA certified Specially designed for NA ✓ Degree of Protection IEC: IP65, UL/CSA Type: -
	abschließbar in Null- stellung, in Kombina- tion mit VHI-PKZ01	IP65	PKZM01 +NHI-E +U oder A +L (2 Stück)	CI-PKZ01-NA-SVB-V 281945	33,00 50	1 Stück 	
	mit NOT-AUS-Pilz- taster rastend	IP65		CI-PKZ01-NA-PVT 281631	46,50 50	1 Stück 	
	mit NOT-AUS-Pilz- taster mit Schlüssel- entriegelung	IP65		CI-PKZ01-NA-PVS 281632	70,10 50	1 Stück 	
für Motorschutzschalter PKZM0 integrierte N- und PE-Klemme, Unterteil ohne Vorgeprägungen							
	mit schwarz-grauem Drehgriff	IP55	PKZM0-... +NHI oder U oder A +NHI-E +L-PKZ0 (2 Stück)	CI-K2-PKZ0-NA-G 262680	14,10 50	1 Stück 	Product Standards UL 508; CSA-C22.2 No. 14; IEC60947-4-1; CE marking UL File No. E36332 UL CCN NLRV CSA File No. 165628 CSA Class No. 3211-05 NA Certification UL Listed, CSA certified Specially designed for NA ✓ Degree of Protection IEC: IP55, UL/CSA Type: 1, 12, 3R
	mit rot-gelbem Dreh- griff zur Verwendung als NOT-AUS-Schal- ter nach EN 60204	IP55		CI-K2-PKZ0-NA-GR 262681	18,60 50	1 Stück 	
für Motorschutzschalter PKZM0 mit voreilendem Hilfsschalter integrierte N- und PE-Klemme, Unterteil ohne Vorgeprägungen							
	mit schwarz-grauem Drehgriff	IP55	PKZM0-... +VHI... + U... +L-PKZ0 (2 Stück)	CI-K2-PKZ0-NA-GV 262682	14,10 50	1 Stück 	
	mit rot-gelbem Dreh- griff zur Verwendung als NOT-AUS-Schal- ter nach EN 60204	IP55		CI-K2-PKZ0-NA-GRV 262683	18,60 50	1 Stück 	

	Schutzart	verwendbar für	Typ Artikel-Nr.	Preis pro Stück Euro RG	VPE	Information relevant for export to North America 
Zusatzrüstung Isolierstoffgehäuse						
Vorhängeschlossperre für max. 3 Bügelschlösser mit 3 - 6 mm Bügelstärke für den Einsatz als Hauptschalter nach EN 60204						
	–	Abschließbar in der 0-Stellung des Motorschutzschalters PKZM0 bzw. PKZM4.	CI-K2-PKZ0-G(R)(V) CI-PKZ0-G(R)(V)M	SVB-PKZ0-CI 035129	8,80 50	3 Stück 
	–	–	E-PKZ0-G(R)	SVB-PKZ0-E 035127	8,80 50	3 Stück 
	–	–	CI-K4-PKZ4-G(R)	SVB-PKZ4-CI 225526	9,65 50	1 Stück
Neutralleiterklemme zum Anschluss eines 5. Leiters						
	–	feindrähtig, 1 - 4 mm ²	CI-K2-PKZ0-...	K-CI-K1/2 207451	2,05 48	20 Stück 
	–	63 A, feindrähtig, 6 - 16 mm ²	CI-K4-PKZ4-G(R)	K25/1 096200	4,40 58	10 Stück
	–	–	E-PKZ0(-G)(-GR) E-PKZ01(-G)	N-PKZ0 082160	2,55 50	20 Stück
Einsätze für Isolierstoffgehäuse PKZ01						
Kombinierbar mit CI-PKZ01-X und E-PKZ01-X.						
	mit Betätigungsmembran	Front IP65	PKZM01 +NHI-E oder VHI-PKZ01 +U oder A oder NHI +L (2 Stück)	CI/E-PKZ01-XG 289936	9,35 50	1 Stück
	abschließbar in Nullstellung		PKZM01 +NHI-E +U oder A +L (2 Stück)	CI/E-PKZ01-XSVB 289939	16,60 50	
	mit NOT-AUS-Piltaster rastend		PKZM01 +NHI-E oder VHI-PKZ01 +U oder A +L (2 Stück)	CI/E-PKZ01-XPVT 289937	29,80 50	
	mit NOT-AUS-Piltaster mit Schlüsselentriegelung		PKZM01 +NHI-E oder VHI-PKZ01 +U oder A +L (2 Stück)	CI/E-PKZ01-XPVS 289938	53,10 50	
	abschließbar in Nullstellung, in Kombination mit VHI-PKZ01		PKZM01 VHI-PKZ01 +U oder A +L (2 Stück)	CI/E-PKZ01-XSVB-V 289980	16,60 50	







	Leitungseinführung	Bohrungsdurchmesser mm	Kabelaußendurchmesser mm	Typ Artikel-Nr.	Preis pro Stück Euro RG	VPE		
Kabelverschraubungen metrisch nach EN 50262								
<ul style="list-style-type: none"> mit Gegenmutter und integrierter Zugentlastung IP68 bis 5 bar, halogenfrei 								
	M20	20,5	6 - 13	V-M20 206910	1,45 58	20 Stück		
	M25	25,5	9 - 17	V-M25 206911	1,65 58			
	M32	32,5	13 - 21	V-M32 206912	2,55 58	10 Stück		
	M32	32,5	18 - 25	V-M32G 226156	3,05 58			
Membrantüllen metrisch								
<ul style="list-style-type: none"> IP66 mit integrierter Durchsteckmembran 								
	M20	20,5	1 - 13	KT-M20 207602	0,40 58	100 Stück		
	M25	25,5	1 - 18	KT-M25 207603	0,40 58			
	M32	32,5	1 - 25	KT-M32 207604	0,40 58			
				verwendbar für	Typ Artikel-Nr.	Preis pro Stück Euro RG	VPE	Hinweise
Türkupplungsgriff								
Schutzart IP65, UL/CS Type 4X / Type12								
	für den Einsatz als Hauptschalter nach EN 60204	schwarz	PKZM0 PKZM4	PKZ0-XH¹⁾ 106132	43,80 50	1 Stück  	steckbare Verlängerungsachse PKZ0-XAH beliebig ablängbar für Einbautiefen 100...240 mm. Mitnehmer mit Verlängerungsachse im Lieferumfang enthalten. Mit Schaltstellung EIN/AUS und „+“ (ausgelöst), abschließbar mit 3 Bügelschlössern 4...8 mm Bügelstärke. In Kombination mit VHI20-PKZ0 nicht verwendbar.	
	für den Einsatz als Hauptschalter mit NOT-AUS-Funktion, nach EN 60204	rot-gelb	PKZM0 PKZM4	PKZ0-XRH¹⁾ 106133	49,20 50			
	für den Einsatz als Hauptschalter nach EN 60204 in MCC-Verteilern mit um 90° gedreht eingebautem PKZM0	schwarz	PKZM0 PKZM4	PKZ0-XH-MCC¹⁾ 106136	43,80 50			
	für den Einsatz als Hauptschalter mit NOT-AUS-Funktion nach EN 60204 in MCC-Verteilern mit um 90° gedreht eingebautem PKZM0	rot-gelb	PKZM0 PKZM4	PKZ0-XRH-MCC¹⁾ 106137	49,20 50			
	für den Einsatz als Hauptschalter nach EN 60204	schwarz	PKE	PKE-XH¹⁾ 142416	46,30 5B	1 Stück  		
	für den Einsatz als Hauptschalter mit NOT-AUS-Funktion, nach EN 60204	rot-gelb	PKE	PKE-XRH¹⁾ 142417	52,10 5B			
	für den Einsatz als Hauptschalter nach EN 60204 in MCC-Verteilern mit um 90° gedreht eingebautem PKE	schwarz	PKE	PKE-XH-MCC¹⁾ 142418	46,30 5B			
	für den Einsatz als Hauptschalter mit NOT-AUS-Funktion nach EN 60204 in MCC-Verteilern mit um 90° gedreht eingebautem PKE	rot-gelb	PKE	PKE-XRH-MCC¹⁾ 142419	52,10 5B			
Klemmenabdeckung								
	zur Erhöhung der Schutzart des PKZM4 auf IP2x	–	PKZM4	HB-PKZ4²⁾ 256581	3,80 50	1 Stück  	Geeignet für den Anschluss von Kabeln bis max. 9,5 mm Außendurchmesser	
Steckbare Verlängerungsachse								
–	–	–	PKZM0 PKZM4	PKZ0-XAH¹⁾ 106134	9,25 50	1 Stück  	Mitnehmer nicht enthalten	

Information relevant for export to North America  



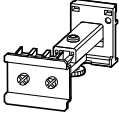





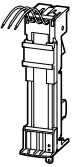

1) Product Standards	UL 508; CSA-C22.2 No. 14; IEC60947-4-1; CE marking
UL File No.	E36332
UL CCN	NLRV
CSA File No.	165628
CSA Class No.	3211-05
NA Certification	UL Listed, CSA certified
Degree of Protection	IEC: IP65, UL/CSA Type: 4X, 12

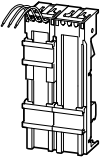
2) Product Standards	UL 508; CSA-C22.2 No. 14; IEC60947-4-1; CE marking
UL File No.	E36332
UL CCN	NLRV
CSA File No.	165628
CSA Class No.	3211-06
NA Certification	UL Listed, CSA certified

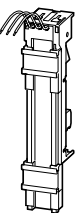
HPL07023DE

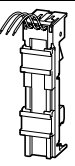
Hinweise			Typ Artikel-Nr.	Preis pro Stück	VPE	Information relevant for export to North America 
				Euro RG		
Teleskopadapter						
mit 45 mm Hutschiene nach IEC/EN 60715 zum Tiefenausgleich bei Zwischenbaumontagen in Gehäusen CI-K... und Schränken						
	Teleskop-Clip	Stufenlos einstellbar über Skalen von 75 - 115 mm.	M22-TA 226161	13,00 51	1 Stück 	Product Standards IEC/EN 60947-5; UL 508; CSA-C22.2 No. 14-05; CSA-C22.2 No. 94-91; CE marking E29184 UL File No. NKCR UL CCN 165628 CSA File No. 3211-03 CSA Class No. UL Listed, NA Certification CSA certified
Abschließbarer Drehknebel						
	zum Abschließen des Motorschutzschalters PKZM0, PKZM4 und PKE als Hauptschalter nach EN 60204. Abschließbar in der „0“-Stellung mit einem Bügelschloss. Bügelstärke 3 - 6.35 mm	Nicht kombinierbar mit VHI-PKZ0.	AK-PKZ0 030851	2,70 50	5 Stück 	Product Standards UL 508; CSA-C22.2 No. 14; IEC60947-4-1; CE marking E36332 UL File No. NLRV UL CCN 165628 CSA File No. 3211-05 CSA Class No. UL Listed, NA Certification CSA certified
Plombierovrrichtung						
	zum Schutz vor Manipulation des Überlastauslösers und der Testfunktion plombierbar mit handelsüblichem Plombendraht zur Verwendung bei Motorschutzschaltern PKZM0 und PKZM4	–	PL-PKZ0 203599	1,30 50	5 Stück	
Dokumentation						
	Motorschutzschalter PKZM0/XTPR...BC1 Überlastüberwachung von Ex e-Motoren	Deutsch/Englisch	MN03402003Z-DE/EN 151986	31,00 30	1 Stück	
	Motorschutzschalter PKZM4/XTPR...DC1 Überlastüberwachung von Ex e-Motoren	Deutsch/Englisch	MN03402002Z-DE/EN 151985	27,20 30		
	Motorschutzschalter PKE12, PKE32 und PKE65 Überlastüberwachung von Ex e-Motoren	Deutsch/Englisch	MN03402004Z-DE/EN 134836	25,90 5B		
Leuchtmelder mit Glühlampe						
	verwendbar für	Farbe	Spannung U_s V	Typ Artikel-Nr.	Preis pro Stück	VPE
	CI-K2-PKZ0-..., CI-K4-PKZ4, CI-PKZ0(1), E-PKZ0(1)	weiß	110 - 230	L-PKZ0(230V) 082151	13,00 50	10 Stück
	CI-K2-PKZ0-..., CI-K4-PKZ4, CI-PKZ0(1), E-PKZ0(1)	weiß	230 - 400	L-PKZ0(400V) 082152	13,00 50	10 Stück
	CI-K2-PKZ0-..., CI-K4-PKZ4, CI-PKZ0(1), E-PKZ0(1)	weiß	415 - 500	L-PKZ0(500V) 082153	13,00 50	5 Stück
	CI-K2-PKZ0-..., CI-K4-PKZ4, CI-PKZ0(1), E-PKZ0(1)	grün	110 - 230	L-PKZ0-GN(230V) 082154	13,00 50	10 Stück
	CI-K2-PKZ0-..., CI-K4-PKZ4, CI-PKZ0(1), E-PKZ0(1)	grün	230 - 400	L-PKZ0-GN(400V) 082155	13,00 50	10 Stück
	CI-K2-PKZ0-..., CI-K4-PKZ4, CI-PKZ0(1), E-PKZ0(1)	grün	415 - 500	L-PKZ0-GN(500V) 082156	13,00 50	5 Stück
	CI-K2-PKZ0-..., CI-K4-PKZ4, CI-PKZ0(1), E-PKZ0(1)	rot	110 - 230	L-PKZ0-RT(230V) 082157	13,00 50	10 Stück
	CI-K2-PKZ0-..., CI-K4-PKZ4, CI-PKZ0(1), E-PKZ0(1)	rot	230 - 400	L-PKZ0-RT(400V) 082158	13,00 50	10 Stück

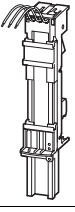
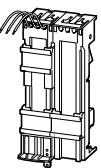

	Bemes- sungs- betriebs- span- nung U _e V	Lei- tungs- quer- schnitt AWG (mm ²)	Adap- ter- breite mm	Trag- schiene Anzahl	verwendbar für	Typ Artikel-Nr.	Preis pro Stück Euro RG	VPE	Hinweise
Sammelschienenadapter für PKZ und PKE									
Zugelassen nach UL 508. Zum Aufbau auf CU-Flachschienen mit 60 mm Schienenmittenabstand, für 5 mm und 10 mm Schienendicke geeignet.									
Bemessungsbetriebsstrom 16 A									
Für Starter mit Federzugklemmen.									
	690	AWG 14 (2,5 mm ²)	45	2	PKZM0-C + DILMC7 PKZM0-C + DILMC9 PKZM0-C + DILMC12	BBA0C-16 101455	28,40 50	4 Stück 	Nach UL 508: I _e = 12 A
Bemessungsbetriebsstrom 25 A									
Für Wendestarter.									
	690	AWG 12 (4 mm ²)	90	1	PKZM0, PKE + 2 x DILM7-01 PKZM0, PKE + 2 x DILM9-01 PKZM0, PKE + 2 x DILM12-01 MSC-R-0,25-M7... - MSC-R-12-M12...	BBA0R-25 101453	49,50 50	2 Stück 	In Kombination mit Einzelkomponenten PKZM0 und DILM Wendestarterset PKZM0-XRM12 verwenden. Fertig montierte und geprüfte Kombination mit MSC-R → Seite 8/24 Für PKE nur Sammelschienenadapter/Verdrahtungssets ab Fertigung KW35/2009 verwendbar.
Universal einsetzbar.									
	690	AWG 12 (4 mm ²)	45	2	-	BBA0-25/2TS 101481	25,80 50	4 Stück 	Tragschienen im Raster 1.25 mm versetzbar.
Für Direktstarter.									
	690	AWG 12 (4 mm ²)	45	1	PKZM0, PKE + 2 x DILM17-01 PKZM0, PKE + 2 x DILM25-01 PKZM0, PKE + 2 x DILM32-01 MSC-R-16-M17... MSC-R-32-M32...	BBA0-25 101451	27,40 50	4 Stück 	In Kombination mit Einzelkomponenten PKZM0 und DILM Direktstarterset PKZM0-XDM12 verwenden. Fertig montierte und geprüfte Kombination mit MSC-D → Seite 8/2 Für PKE nur Sammelschienenadapter/Verdrahtungssets ab Fertigung KW35/2009 verwendbar.
Für Softstarter									
	690	AWG 12 (4 mm ²)	45	1	PKZM0, PKE + DS7...004N... PKZM0, PKE + DS7...007N... PKZM0, PKE + DS7...009N... PKZM0, PKE + DS7...012N...	BBA0L-25 142526	30,00 50	1 Stück	-
Bemessungsbetriebsstrom 32 A									
Für Wendestarter.									
	690	AWG 10 (6 mm ²)	90	3	PKZM0, PKE + 2 x DILM17-01 PKZM0, PKE + 2 x DILM25-01 PKZM0, PKE + 2 x DILM32-01 MSC-R-16-M17... - MSC-R-32-M32...	BBA0R-32 101454	54,70 50	2 Stück 	In Kombination mit Einzelkomponenten PKZM0 und DILM elektrischer Kontaktbaustein PKZM0-XM32DE und Wendeverdrahtungssatz DILM32-XRL verwendbar. Fertig montierte und geprüfte Kombination mit MSC-R → Seite 8/24 Für PKE nur Sammelschienenadapter/Verdrahtungssets ab Fertigung KW 35/2009 verwendbar.

Information relevant for export to North America













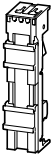

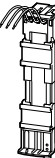

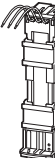

Product Standards

UL 508A; CSA-C22.2 No. 14;
IEC60439-1; CE marking
UL File No.
UL CCN

UL 508A; CSA-C22.2 No. 14;
IEC60439-1; CE marking
E300273
NMTR, NMTRZ

CSA File No.
CSA Class No.
NA Certification
Max. Voltage Rating











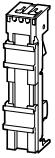





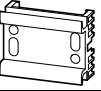

232140
3211-37
UL Listed, CSA certified
600 V AC

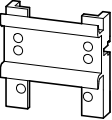
	Bemes- sungs- betriebs- span- nung U _e V	Lei- tungs- quer- schnitt	Adap- ter- breite mm	Trag- schiene Anzahl	verwendbar für	Typ Artikel-Nr.	Preis pro Stück Euro RG	VPE	Hinweise
Bemessungsbetriebsstrom 32 A									
Universal einsetzbar.									
	690	–	45	2	PKZM0..., PKE + DILM...	BBA0-32/2TS-C²⁾ 116708	32,60 50	4 Stück  	Universaladapter für 1-, 2- und 3-phasige Anwendungen. Tragschiene im Raster 1,25 mm versetzbar. Für Leiterquerschnitte, Rundleiter bis 6 mm ² . Für PKE nur Sammelschienenadapter/Verdrahtungssets ab Fertigung KW 35/2009 verwendbar.
Für Direktstarter.									
	690	AWG 10 (6 mm ²)	45	2	PKZM0, PKE + DILM17 PKZM0, PKE + DILM25 PKZM0, PKE + DILM32 MSC-D-16-M17... - MSC-D-32-M32...	BBA0-32¹⁾ 101452	33,10 50	4 Stück  	In Kombination mit Einzelkomponenten PKZM0 und DILM elektrischer Kontaktbaustein PKZM0-XM32DE verwendbar. Fertig montierte und geprüfte Kombination mit MSC-D → Seite 8/2 Für PKE nur Sammelschienenadapter/Verdrahtungssets ab Fertigung KW35/2009 verwendbar.
Für Softstarter									
	690	AWG 10 (6 mm ²)	45	2	PKZM0, PKE + DS7...016N... PKZM0, PKE + DS7...024N... PKZM0, PKE + DS7...032N...	BBA0L-32 142527	36,00 50	1 Stück	–
Für 160-mm-Adaptersystem mit Motorschutzschaltern									
–	690	AWG 10 (6 mm ²)	45	1	PKZM0, PKE	BBA0K-32 142528	31,00 50	1 Stück	–
Bemessungsbetriebsstrom 63 A									
Für Direktstarter.									
	690	AWG 8 (10 mm ²)	55	2	PKZM4 + DILM17 PKZM4 + DILM25 PKZM4 + DILM32 PKZM4 + DILM40 PKZM4 + DILM50 PKZM4 + DILM65	BBA4L-63¹⁾ 101459	40,80 50	4 Stück  	Zur elektrischen Verbindung sind für PKZM4 + DILM17 bis DILM32: MVS-LB0-0M-G PKZM4 + DILM40 bis DILM65: PKZM4-XM65DE verwendbar.
	690	AWG 8 (10 mm ²)	72	2	PKZ2 + DILM7 PKZ2 + DILM9 PKZ2 + DILM12 PKZ2 + DILM15 PKZ2 + DILM17 PKZ2 + DILM25 PKZ2 + DILM32 PKZ2 + DILM40	BBA2L-63¹⁾ 101480	48,80 50	4 Stück  	Zur elektrischen Verbindung sind für PKZ2 + DILM7 bis DILM12: MVS-LB0-00M-G PKZ2 + DILM15 bis DILM32: MVS-LB0-0M-G verwendbar.
Für Motorschutzschalter.									
	690	AWG 8 (10 mm ²)	54	1	PKZM4	BBA4-63¹⁾ 101457	35,80 50	4 Stück  	–
	690	AWG 8 (10 mm ²)	72	1	PKZ2	BBA2-63¹⁾ 101458	48,80 50	4 Stück  	–

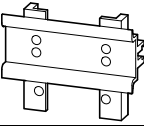
Information relevant for export to North America

1)	
Product Standards	UL 508A; CSA-C22.2 No. 14; IEC60439-1; CE marking
UL File No.	E300273
UL CCN	NMTR, NMTR7
CSA File No.	232140
CSA Class No.	3211-37
NA Certification	UL Listed, CSA certified
Max. Voltage Rating	600 V AC

2)	
Product Standards	UL 508A; CSA-C22.2 No. 14; IEC60439-1; CE marking
UL File No.	E300273
UL CCN	NMTR, NMTR7
NA Certification	UL Listed, CSA certified
Max. Voltage Rating	600 V AC













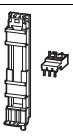

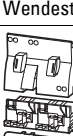

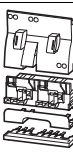

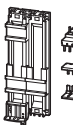

	Bemes- sungs- betriebs- span- nung U _e V	Lei- tungs- quer- schnitt	Adap- ter- breite mm	Trag- schiene Anzahl	verwendbar für	Typ Artikel-Nr.	Preis pro Stück Euro RG	VPE	Hinweise
Ohne elektrische Kontaktierung									
Leermodul.									
	-	-	45	2	-	BBA0/2TS-L¹⁾ 101482	19,60 50	4 Stück  	Tragschienen im Raster 1.25 mm versetzbar. Zum Aufbau von Wende- und Stern-Dreieck-Startern verwendbar.
	-	-	54	2	-	BBA4/2TS-L¹⁾ 101483	27,00 50	4 Stück  	Tragschienen im Raster 1.25 mm versetzbar. Zum Aufbau von Wende- und Stern-Dreieck-Startern verwendbar.
Seitenmodul beidseitig ansteckbar.									
	-	-	9	-	-	BBA-XSM¹⁾ 101484	8,05 50	10 Stück  	Anreihbar an Sammelschienenadapter zur Erweiterung der Aufbaubreite.
Sammelschienenadapter Zusatzausrüstung									
Tragschienen									
	-	-	45	-	BBA...	PKZM0-XMR²⁾ 239364	2,10 50	10 Stück  	-
	-	-	54	-	BBA...	PKZM0-XMR⁵⁴²⁾ 113911	2,35 50	10 Stück  	-
	-	-	72	-	BBA...	PKZM0-XMR⁷²²⁾ 113912	3,20 50	10 Stück  	-
Anschlusskabel									
-	-	-	-	-	BBA...	BBA-XLT-6-130³⁾ 116902	1,70 50	30 Stück  	-
-	-	-	-	-	BBA...	BBA-XLT-16-142³⁾ 116903	2,15 50	30 Stück  	-

Information relevant for export to North America

1)	
Product Standards	UL 508A; CSA-C22.2 No. 14; IEC60439-1; CE marking
UL File No.	E300273
UL CCN	NMTR, NMTR7
CSA File No.	232140
CSA Class No.	3211-37
NA Certification	UL Listed, CSA certified
Max. Voltage Rating	600 V AC

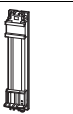

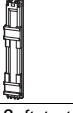

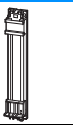
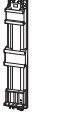

2)	
Product Standards	UL 508; CSA-C22.2 No. 14; IEC60947-4-1; CE marking
UL File No.	E300273
UL CCN	NMTR, NMTR7
CSA File No.	232140
CSA Class No.	3211-37
NA Certification	UL Listed, CSA certified



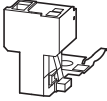

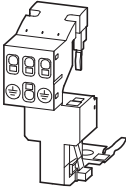









3)	
Product Standards	UL 508A; CSA-C22.2 No. 14; IEC60439-1; CE marking
UL File No.	On request
UL CCN	On request
CSA File No.	On request
CSA Class No.	On request
NA Certification	UL Recognized, CSA certified

verwendbar für	Typ Artikel-Nr.	Preis pro Stück	VPE	Hinweise
Verdrahtungsset				
Direktstarter				
	PKZM0, PKE + DILM7 PKZM0, PKE + DILM9 PKZM0, PKE + DILM12 PKZM0, PKE + DILM15 DS7-34...SX004... DS7-34...SX007... DS7-34...SX009... DS7-34...SX012...	PKZM0-XDM12 283149	6,25 50	1 Stück   Besteht aus: • mechanischem Verbindungsbaustein für PKZM0 und Schütz • Hauptstromverdrahtung zwischen PKZM0 und Schütz in Kombistecktechnik • Leitungsführung Als Schützhilfsschalter DILA-XHIT... verwenden → Seite 5/40 Nicht kombinierbar mit NHI-E...PKZ0-C. $U_g \leq 415 \text{ V}^{1)}$
	PKZM0, PKE + DILM17 PKZM0, PKE + DILM25 PKZM0, PKE + DILM32	PKZM0-XDM32 283153	8,95 50	1 Stück   Besteht aus: • Hutschienenadapterplatte • Hauptstromverdrahtung zwischen PKZ und Schütz ¹⁾
	PKZM4 + DILM40 PKZM4 + DILM50 PKZM4 + DILM65	PKZM4-XDM65 101053	32,10 50	1 Stück  
Wendestarter				
	PKZM0, PKE + DILM7-01 PKZM0, PKE + DILM9-01 PKZM0, PKE + DILM12-01	PKZM0-XRM12 283185	22,00 50	1 Stück   Besteht aus: • mechanischem Verbindungsbaustein für PKZM0 und Schütz • Hauptstromverdrahtung Wendestarter in Kombistecktechnik • Steuerleitungen zur elektrischen Verriegelung in Kombistecktechnik: – K1M: A1 -K2M: 21 – K1M: 21 -K2M: A1 – K1M: A2 -K2M: A2 • Leitungsführung als Schützhilfsschalter DILA-XHIT...verwenden → Seite 5/40 Nicht kombinierbar mit AGM-PKZ0. $U_g \leq 415 \text{ V}^{1)}$
	PKZM0, PKE + DILM17 PKZM0, PKE + DILM25 PKZM0, PKE + DILM32	PKZM0-XRM32 283189	27,10 50	1 Stück   Besteht aus: • Hutschienenadapterplatte • Hauptstromverdrahtung Wendestarter ¹⁾
Elektrischer Kontaktbaustein				
	PKZM0, PKE + DILM17 PKZM0, PKE + DILM25 PKZM0, PKE + DILM32 DS7-34...SX016... DS7-34...SX024... DS7-34...SX032...	PKZM0-XM32DE 239349	2,75 50	5 Stück   • Hauptstromverdrahtung zwischen PKZM0 + Schütz • nur in Kombination mit Sammelschienenadapter oder Hutschienenadapterplatte verwenden
	PKZM4 + DILM40 PKZM4 + DILM50 PKZM4 + DILM65	PKZM4-XM65DE 101056	15,00 50	5 Stück   • Hauptstromverdrahtung zwischen PKZM4 + Schütz
Hutschienenadapterplatte				
	PKZM0-XDM12 PKZM0-XRM12	PKZM0-XC45 283132	6,70 50	4 Stück   besteht aus: • 45 mm breiter Adapterplatte • Verbindungsnocke zum Anreihen weiterer Platten ¹⁾
	PKZM4 + DILM40 PKZM4 + DILM50 PKZM4 + DILM65	PKZM4-XC55/2 101054	17,40 50	4 Stück   besteht aus: • 55 mm breiter Adapterplatte • Verbindungsnocke für weitere Platten • verwendbar für Wende- und Stern-Dreieckstarter ¹⁾
Softstarter				
	PKZM0, PKE + DS7...004N... PKZM0, PKE + DS7...007N... PKZM0, PKE + DS7...009N... PKZM0, PKE + DS7...012N...	PKZM0-XC45L 142529	11,50 50	1 Stück besteht aus: • 45 mm breiter Adapterplatte
	PKZM0, PKE + DS7...016N... PKZM0, PKE + DS7...024N... PKZM0, PKE + DS7...032N...	PKZM0-XC45L/2 142570	12,40 50	1 Stück besteht aus: • 45 mm breiter Adapterplatte

Hinweise¹⁾ Für PKE nur Sammelschienenadapter/Verdrahtungssets ab Fertigung KW35/2009 verwenden.**Information relevant for export to North America**  

2)	Product Standards	UL 508; CSA-C22.2 No. 14; IEC60947-4-1; CE marking	3)	UL/CSA certification not required	4)	Product Standards	UL 508; CSA-C22.2 No. 14; IEC60947-4-1; CE marking
	UL File No.	E36332				UL File No.	E300273
	UL CCN	NLRV				UL CCN	NMTR
	CSA File No.	165628				CSA File No.	232140
	CSA Class No.	3211-05				CSA Class No.	3211-37
	NA Certification	UL Listed, CSA certified				NA Certification	UL Listed, CSA certified

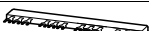







Beschreibung	verwendbar für	Typ Artikel-Nr.	Preis pro Stück Euro RG	VPE	Hinweise	Information relevant for export to North America 
Motorabgangsstecker						
PE-Modul mit Kontaktblech						
	DILM(C)7 DILM(C)9 DILM(C)12 DILM(C)15	DILM12-XMCE 121764	7,45 30	5 Stück 	Tragschiene 35 x 7.5 (15) mm nach DIN EN 60715 mit PE-Funktion erforderlich. Anschlussmöglichkeit: PE 0.75 – 4 mm ²	Product Standards UL 508; CSA-C22.2 No. 14; IEC60947-4-1; CE marking NA Certification Request filed for UL and CSA
Motorabgangsstecker mit PE-Modul und Kontaktblech						
	DILM(C)7 DILM(C)9 DILM(C)12 DILM(C)15	DILM12-XMCP/E 121769	18,80 30	1 Stück 	Tragschiene 35 x 7.5 (15) mm nach DIN EN 60715 mit PE-Funktion erforderlich. Anschlussmöglichkeit: L1, L2, L3, PE 0.75 – 2.5 mm ²	Product Standards IEC/EN 60947-4-1; UL 508; CSA-C22.2 No. 14-05; CE marking NA Certification Request filed for UL and CSA
Motorabgangsstecker mit PE-Modul ohne Kontaktblech						
	PKZM0/PKE + DILM(C)7 PKZM0/PKE + DILM(C)9 PKZM0/PKE + DILM(C)12 PKZM0/PKE + DILM(C)15 MSC-D(E)-...-M7... MSC-D(E)-...-M9... MSC-D(E)-...-M15...	DILM12-XMCP/T 121770	17,50 30	1 Stück 	Anschlussmöglichkeit: L1, L2, L3, PE 0.75 – 2.5 mm ²	Product Standards IEC/EN 60947-4-1; UL 508; CSA-C22.2 No. 14-05; CE marking NA Certification Request filed for UL and CSA

	Schutzschalter Anzahl	Länge mm	Teilungsmaß mm	Typ Artikel-Nr.	Preis pro Stück Euro RG	VPE	Hinweise
Drehstromschienenblock, Einspeisung an den Klemmen 1, 3, 5							
berührungssicher, kurzschlussfest, U ₀ =690 V, I ₀ =63 A verlängerbar durch gedrehte Montage							
für PKZM0-... oder PKE ohne seitlich angebaute Hilfsschalter oder Spannungsauslöser							
	2	90	45	B3.0/2-PKZO ¹⁾ 063961	10,10 50	10 Stück 	zur parallelen Einspeisung mehrerer Motorschutzschalter an den Klemmen 1, 3, 5
	3	135	45	B3.0/3-PKZO ¹⁾ 232289	11,90 50		
	4	180	45	B3.0/4-PKZO ¹⁾ 063960	13,40 50		
	5	225	45	B3.0/5-PKZO ¹⁾ 232290	14,70 50		
für Motorschutzschalter mit je einem Hilfsschalter oder Ausgelöstmelder rechts angebaut							
	2	99	45 + 9	B3.1/2-PKZO ¹⁾ 044945	10,10 50	10 Stück 	zur parallelen Einspeisung mehrerer Motorschutzschalter an den Klemmen 1, 3, 5
	3	153	45 + 9	B3.1/3-PKZO ¹⁾ 044946	11,90 50		
	4	207	45 + 9	B3.1/4-PKZO ¹⁾ 044947	13,40 50		
	5	261	45 + 9	B3.1/5-PKZO ¹⁾ 044948	14,70 50		
für PKZM0-... oder PKE mit je einem Hilfsschalter und einem Ausgelöstmelder rechts angebaut oder einem Spannungsauslöser links angebaut							
	2	108	45 + 18	B3.2/2-PKZO ¹⁾ 063963	10,70 50	10 Stück 	zur parallelen Einspeisung mehrerer Motorschutzschalter an den Klemmen 1, 3, 5
	4	234	45 + 18	B3.2/4-PKZO ¹⁾ 063959	14,10 50	10 Stück 	

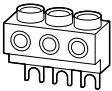
Information relevant for export to North America

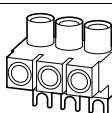

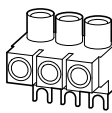
1)
Product Standards UL 508; CSA-C22.2 No. 14; IEC60947-4-1; CE marking
UL File No. E36332
UL CCN NLRV
CSA File No. 98494
CSA Class No. 3211-06
NA Certification UL Listed, CSA certified









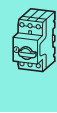

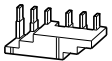

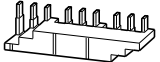
Schutzschalter Anzahl	verwend- bar für	Teilungsmaß mm	Typ Artikel-Nr.	Preis pro Stück Euro RG	VPE	Hinweise
Leerschlussabdeckung						
berührungssicher zur Abdeckung von nicht belegten Anschlüssen am Drehstromschienenblock B3...-PKZ0						
	-	-	H-B3-PKZ0¹⁾ 032721	1,85 50	20 Stück  	-
Einspeiseklemme						
	-	PKZM0 PKE	BK25/3-PKZ0²⁾ 032720	9,45 50	5 Stück  	für Drehstromschienenblock, berührungssicher, $U_e = 690\text{ V}$, $I_u = 63\text{ A}$ für Leiterquerschnitte: 2,5 - 25 mm ² mehrdrähtig 2,5 - 16 mm ² feindrähtig mit Ader- endhülle AWG 14 - 6, einsetzbar an den Klemmen 1, 3, 5
	-	PKZM0	BK25/3-PKZ0-E³⁾ 262518	9,90 50	5 Stück  	für Drehstromschienenblock, berührungssicher, $U_e = 690\text{ V}$, $I_u = 60\text{ A}$ für Leiterquerschnitte: 2,5 - 25 mm ² mehrdrähtig 2,5 - 16 mm ² feindrähtig mit Ader- endhülle AWG 14 - 6 Zum Aufbau von type E Startern.
	-	PKZM4	BK50/3-PKZ4-E⁴⁾ 272165	31,70 50	1 Stück  	Kombinierbar mit Drehstromschienen- block B3...PKZ4. $I_u = 120\text{ A}$. Zum Aufbau von type E Startern.

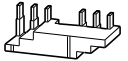



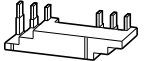

Information relevant for export to North America



1)	Product Standards UL File No. UL CCN CSA File No. CSA Class No. NA Certification	UL 508; CSA-C22.2 No. 14; IEC60947-4-1; CE marking E36332 NLRV 98494 3211-06 UL Listed, CSA certified	2)	Product Standards UL File No. UL CCN CSA File No. CSA Class No. NA Certification	UL 508; CSA-C22.2 No. 14; IEC60947-4-1; CE marking E36332 NLRV 165628 3211-05 UL Listed, CSA certified
3)	Product Standards UL File No. UL CCN CSA File No. CSA Class No. NA Certification Specially designed for NA Suitable for	UL 508; CSA-C22.2 No. 14; IEC60947-4-1; CE marking E36332 NLRV 98494 3211-06 UL Listed, CSA certified ✓ PKZM0/PKE, line terminal required for Type E/F applications	4)	Product Standards UL File No. UL CCN CSA File No. CSA Class No. NA Certification Specially designed for NA Suitable for	UL 508; CSA-C22.2 No. 14; IEC60947-4-1; CE marking E36332 NLRV 165628 3211-06 UL Listed, CSA certified ✓ PKZM4/PKE, line terminal required for Type E/F applications



Schutzschalter	Länge	Teilungsmaß	Typ	Preis	VPE	Information relevant for export to North America
Anzahl	mm	mm	Artikel-Nr.	pro Stück		
				Euro		
				RG		
Drehstromschienenblock						
berührungssicher, kurzschlussfest $U_n=690\text{ V}$, $I_n=128\text{ A}$						
für PKZM4 ohne seitlich angebaute Hilfsschalter oder Spannungslöser						
	2	110	55	B3.0/2-PKZ4 220220	18,70 50	1 Stück 
	3	165		B3.0/3-PKZ4 220221	24,50 50	
	4	220		B3.0/4-PKZ4 220222	30,10 50	
für PKZM4 mit je einem Hilfsschalter bzw. Ausgelöstmelder recht angebaut						
	2	119	55 + 9	B3.1/2-PKZ4 220223	19,50 50	1 Stück 
	3	183		B3.1/3-PKZ4 220224	25,10 50	
	4	247		B3.1/4-PKZ4 220225	30,80 50	
für PKZM4 mit je einem Hilfsschalter bzw. Ausgelöstmelder rechts angebaut oder einem Spannungsauslöser links angebaut						
	2	128	55 + 18	B3.2/2-PKZ4 220226	21,40 50	1 Stück 
	4	274		B3.2/4-PKZ4 220227	32,40 50	
Leeranschlussabdeckung						
berührungssicher zur Abdeckung von nicht belegten Anschlüssen am Drehstromschienenblock						
	-	-	-	H-B3-PKZ4 220228	3,45 50	10 Stück 
Product Standards UL 508; CSA-C22.2 No. 14; IEC60947-4-1; CE marking						
UL File No. E36332						
UL CCN NLRV						
CSA File No. 165628						
CSA Class No. 3211-06						
NA Certification UL Listed, CSA certified						

Betätigungsspannung	Typ Artikel-Nr.	Preis pro Stück Euro RG	VPE	Typ Artikel-Nr.	Preis pro Stück Euro RG	VPE	Hinweise			
Arbeitsstromauslöser, Unterspannungsauslöser										
AC										
Normalspannung										
24 V 50 Hz	A-PKZ0(24V50HZ) 073181	29,50 50	2 Stück 	U-PKZ0(24V50HZ) 073129	29,50 50	2 Stück 	Bei PKE nur A-PKZ0 oder U-PKZ0... ab Seriennummer 02 anbaubar.			
110 V 50 Hz	A-PKZ0(110V50HZ) 073184	29,50 50		U-PKZ0(110V50HZ) 073132	29,50 50					
220 V 50 Hz	A-PKZ0(220V50HZ) 073186	29,50 50		U-PKZ0(220V50HZ) 073134	29,50 50					
230 V 50 Hz	A-PKZ0(230V50HZ) 073187	29,50 50		U-PKZ0(230V50HZ) 073135	29,50 50					
240 V 50 Hz	A-PKZ0(240V50HZ) 073188	29,50 50		U-PKZ0(240V50HZ) 073136	29,50 50					
380 V 50 Hz	A-PKZ0(380V50HZ) 073189	29,50 50		U-PKZ0(380V50HZ) 073137	29,50 50					
400 V 50 Hz	A-PKZ0(400V50HZ) 073190	29,50 50		U-PKZ0(400V50HZ) 073138	29,50 50					
415 V 50 Hz	A-PKZ0(415V50HZ) 073191	29,50 50		U-PKZ0(415V50HZ) 073139	29,50 50					
120 V 60 Hz	A-PKZ0(120V60HZ) 073195	29,50 50		U-PKZ0(120V60HZ) 073143	29,50 50					
240 V 60 Hz	A-PKZ0(240V60HZ) 073198	29,50 50		U-PKZ0(240V60HZ) 073146	29,50 50					
440 V 60 Hz	A-PKZ0(440V60HZ) 082164	29,50 50		U-PKZ0(440V60HZ) 082161	29,50 50					
480 V 60 Hz	A-PKZ0(480V60HZ) 073199	29,50 50		U-PKZ0(480V60HZ) 073147	29,50 50					
Sonderspannungen außer den vor- genannten Normalspannungen										
... V 50 Hz (24 - 500 V)	A-PKZ0(*V50HZ) 982165	35,80 50		2 Stück 	U-PKZ0(*V50HZ) 982162			35,80 50	2 Stück 	Bei PKE nur A-PKZ0 oder U-PKZ0... ab Seriennummer 02 anbaubar. Die Artikel-Nr. ergibt sich aus der Kombination von Typ und Betätigungsspannung. Bei den Sonderspannungen ist die gewünschte Betätigungsspannung aus dem angegebenen Bereich (...-...V) anzugeben. Mindestbestellmenge 10 Stück.
... V 60 Hz (24 - 600 V)	A-PKZ0(*V60HZ) 982166	35,80 50	U-PKZ0(*V60HZ) 982163		35,80 50					
DC										
Normalspannung										
24 V DC	A-PKZ0(24VDC) 073200	37,20 50	2 Stück 	U-PKZ0(24VDC) 157862	64,70 50	2 Stück 	Bei PKE nur A-PKZ0 oder U-PKZ0... ab Seriennummer 02 anbaubar.			
110 V DC	A-PKZ0(110VDC) 073203	37,20 50		-						



Information relevant for export to North America



Product Standards UL 508; CSA-C22.2 No. 14; IEC60947-4-1;
CE marking
UL File No.E36332
UL CCNLRV
CSA File No.165628
CSA Class No.3211-05
NA Certification UL Listed, CSA certified

PKZ, PKZM

Projektieren

PKZM0 und PKZM4 in 1- und 2-poliger Schaltung bei Gleich- und Wechselstrom



PKZM0(1) und PKZM4 in 2-poliger Schaltung mit CL-PKZ0

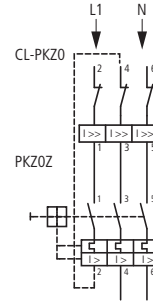

Schutz von PVC-isolierten Leitungen gegen thermische Überlastung bei Kurzschluss

Die Tabelle gibt an, welche minimalen Leiterquerschnitte durch Motorschutzschalter bis zu ihrem bedingten Bemessungskurzschlussstrom I_q geschützt sind.

min. geschützter Querschnitt 380 – 415 V, 50 Hz, Cu mm ²	Gerät Typ	Auslöseblock Typ	geschützter Minimalquerschnitt in mm ²							
			0,5	0,75	1,5	2,5	4	6	10	16
	PKZM0-0,16	PKE-XTU(A)-1,2								
	⋮	PKE-XTU(A)-4								
	PKZM0-6,3	PKE-XTU(A)-12								
	PKZM0-10	PKE-XTU(A)-32								
	PKZM0-12	PKE-XTUCP(A)-36								
	PKZM0-16	PKE-XTUW(A)-32								
	PKZM0-20	PKE-XTU(A)-65								
	PKZM0-25	PKE-XTUWCP(A)-36								
	PKZM0-32	PKE-XTUCP(A)-65								
	PKZM4-16									
	PKZM4-25									
	PKZM4-32									
	PKZM4-40									
	PKZM4-50									
	PKZM4-58									
	PKZM4-63									

Auslösekennlinien Motorschutzschalter PKZM0...T (nicht für PKM0-...), PKZM01

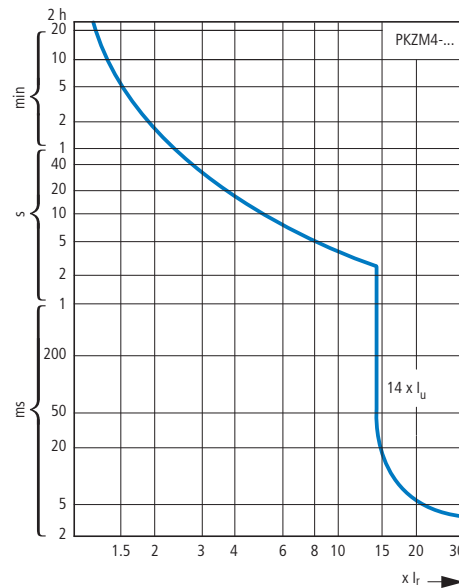
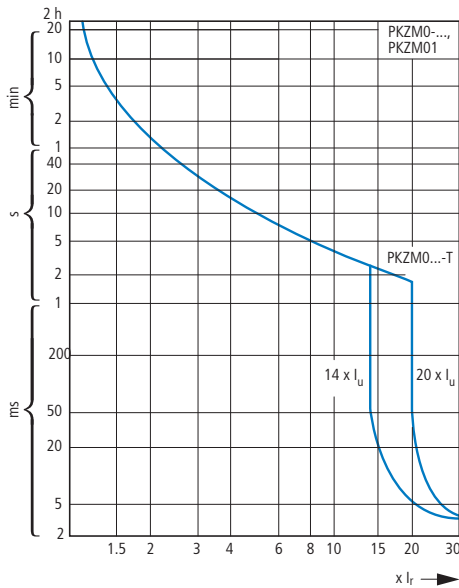

Auslösekennlinien Weitbereichsschutzschalter PKE

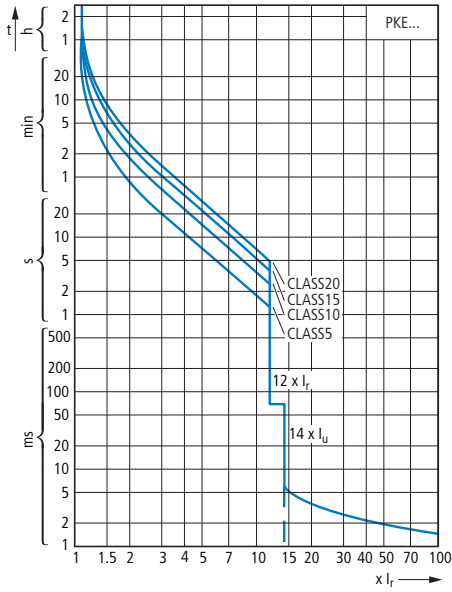

Durchlasswerte Motorschutzschalter, Transformatorschutzschalter, Schutzschalter für Starterkombinationen

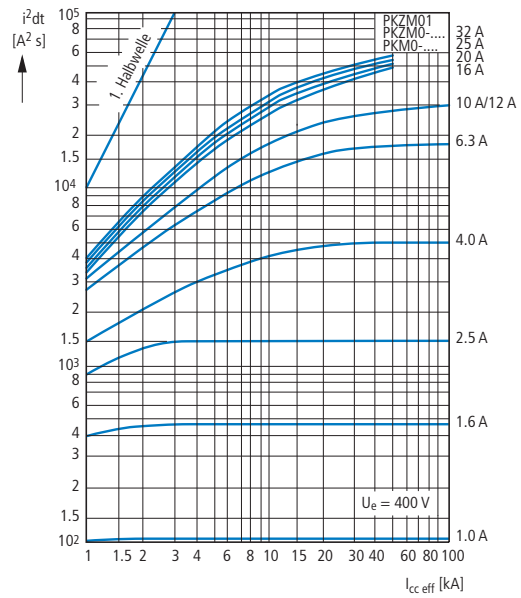
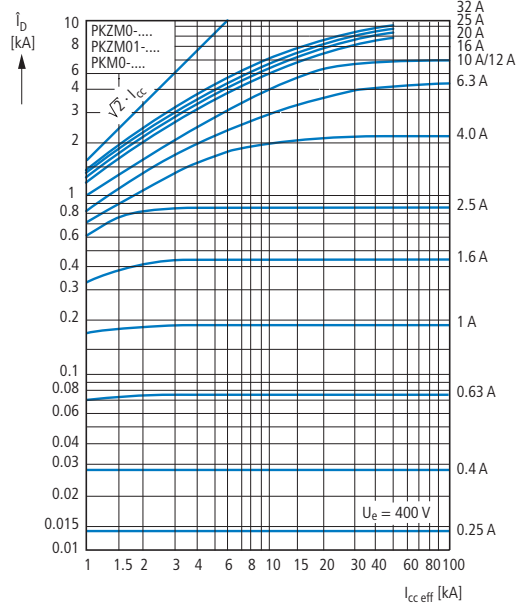

Durchlasswerte Motorschutzschalter

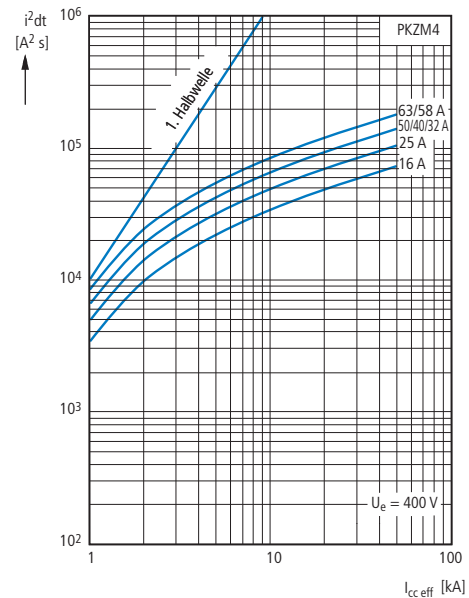
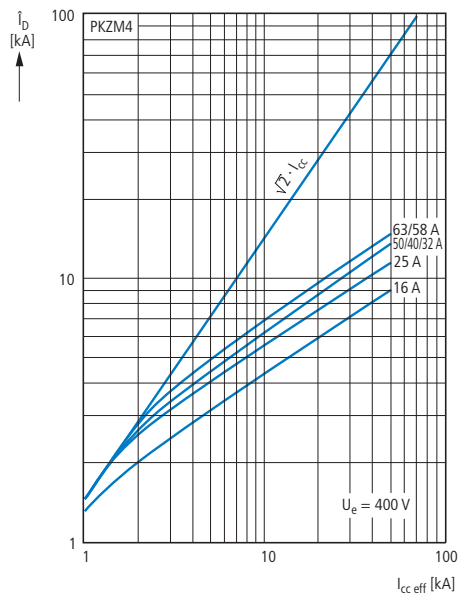

Durchlassstrom

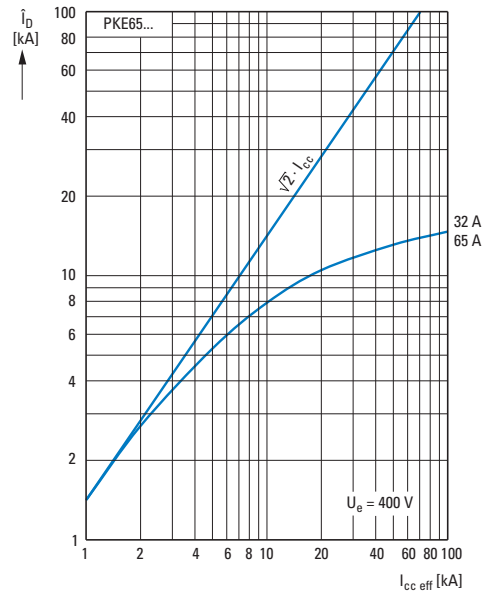
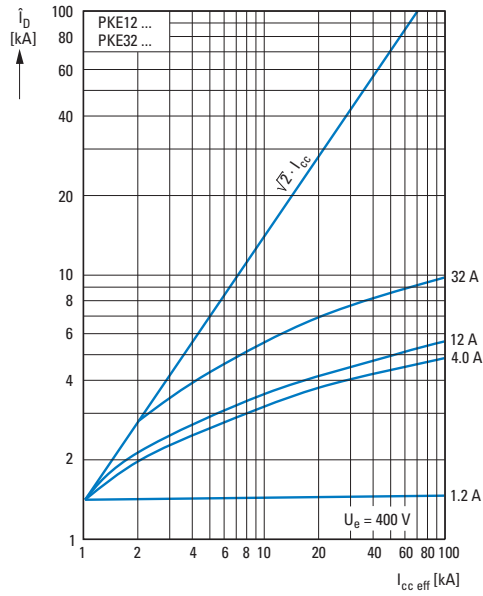

Durchlassenergie

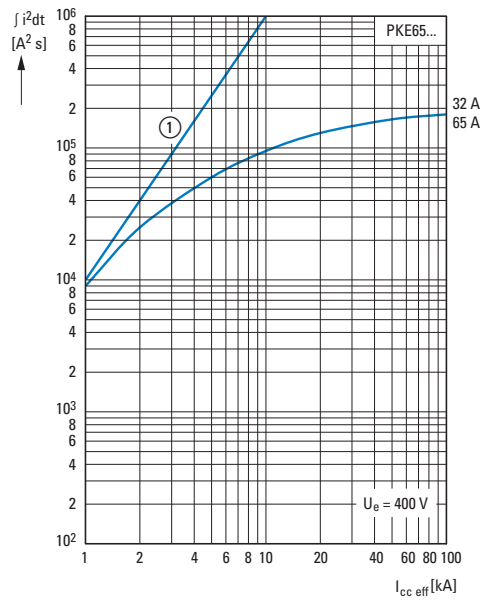
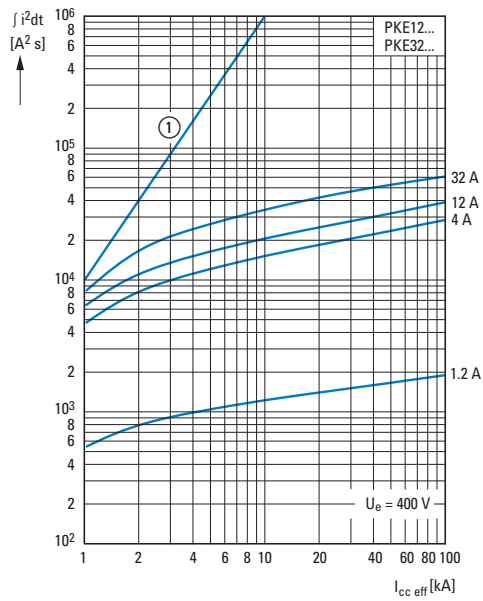

① 1. Halbwellen

Schaltvermögen Schutzschalter ab Serien-Nr. 04

Bemessungsdauerstrom I_u

Bedingter Bemessungskurzschlussstrom I_q IEC/EN 60947-4-1

Bemessungsgrenzkurzschlussausschaltvermögen I_{cu}
 Bemessungsbetriebskurzschlussausschaltvermögen I_{cs} } IEC/EN 60947-2

I_u A	230 V				400 V				440 V				500 V				690 V			
	I_q kA	I_{cu} kA	I_{cs} kA	A ¹⁾	I_q kA	I_{cu} kA	I_{cs} kA	A ¹⁾	I_q kA	I_{cu} kA	I_{cs} kA	A ¹⁾	I_q kA	I_{cu} kA	I_{cs} kA	A ¹⁾	I_q kA	I_{cu} kA	I_{cs} kA	A ¹⁾

PKZM0, PKZM0...-T, PKM0 mit Zuordnungsart „1“ und „2“

0,16 – 1	150	150	150	N	150	150	150	N				N				N				N
1,6	150	150	150	N	150	150	150	N				N				N				N
2,5	150	150	150	N	150	150	150	N				N				N	5	5	5	50
4	150	150	150	N	150	150	150	N				N				N	3	3	3	50
6,3	150	150	150	N	150	150	150	N				N	42	42	11	50	3	3	2	50
10	150	150	150	N	150	150	150	N	42	42	12	50	42	42	11	50	3	3	2	50
12	50	50	13	50	50	50	13	50	15	15	12	50	15	15	8	50	3	3	2	50
16	50	50	13	50	50	50	13	50	15	15	12	50	15	15	8	50	3	3	2	50
20	50	50	13	50	50	50	13	50	10	10	13	50	6	6	3	50	3	3	1	50
25	50	50	13	50	50	50	13	50	10	10	13	50	6	6	3	50	3	3	1	50
32	50	50	13	50	50	50	13	50	10	10	13	50	6	6	3	50	3	3	1	50

PKZM0 (PKZM0...-T, PKM0) + CL-PKZ0

0,16 – 1				N				N				N							20	N
1,6				N				N				N							20	N
2,5				N				N				N					20	20	20	N
4				N				N				N					20	20	20	N
6,3				N				N				N	50	N			20	20	20	N
10				N				N				N	20	N			20	20	20	N
12				N				N				N	20	N			5	5	2,5	N
16				N				N				N	20	N			5	5	2,5	N
20				N				N				N	10	10	10	N	5	5	2,5	N
25				N				N				N	10	10	10	N	5	5	2,5	N
32				N				N				N	10	10	10	N	5	5	2,5	N

PKZM0 (PKZM0...-T, PKM0) + 2 CL-PKZ0

0,16 – 1				N				N				N							20	N
1,6				N				N				N							20	N
2,5				N				N				N					40	40	20	N
4				N				N				N					40	40	20	N
6,3				N				N				N	50	N			20	20	20	N
10				N				N				N	40	N			20	20	20	N
12				N				N				N	40	N			10	10	2,5	N
16				N				N				N	40	N			10	10	2,5	N
20				N				N				N	20	20	20	N	10	10	2,5	N
25				N				N				N	20	20	20	N	10	10	2,5	N
32				N				N				N	20	20	20	N	10	10	2,5	N

Hinweise

Kein vorgeschaltetes Schutzorgan notwendig, da eigener Bereich (100/150 kA)

¹⁾ Erforderliche Vorsicherung, wenn der Kurzschlussstrom den bedingten Bemessungskurzschlussstrom der Geräte übersteigt ($I_{cc} > I_q$).

N Nicht erforderlich



Schaltvermögen Schutzschalter

Bemessungsdauerstrom I_u Bedingter Bemessungskurzschlussstrom I_q IEC/EN 60947-4-1Bemessungsgrenzkurzschlussausschaltvermögen I_{cu} Bemessungsbetriebskurzschlussausschaltvermögen I_{cs} } IEC/EN 60947-2

I_u A	230 V				400 V				440 V ²⁾				500 V ²⁾				690 V ²⁾			
	I_q kA	I_{cu} kA	I_{cs} kA	A ¹⁾	I_q kA	I_{cu} kA	I_{cs} kA	A ¹⁾	I_q kA	I_{cu} kA	I_{cs} kA	A ¹⁾	I_q kA	I_{cu} kA	I_{cs} kA	A ¹⁾	I_q kA	I_{cu} kA	I_{cs} kA	A ¹⁾

PKZM01 mit Zuordnungsart „1“ und „2“

0,16 – 1	50	50	50	50	50	50	50	50	50	50	50	50
1,6	50	50	50	50	50	50	50	50	50	50	50	50
2,5	50	50	50	50	50	50	50	50	50	50	50	50
4	50	50	50	50	50	50	50	50	50	50	50	50
6,3	50	50	50	50	50	50	50	50	50	50	50	50
10	50	50	50	50	50	50	50	50	42	42	10	50
12	50	50	10	50	50	50	10	50	15	15	10	50
16	50	50	10	50	50	50	10	50	15	15	10	50
20, 25	50	50	10	50	50	50	10	50	10	10	3	50

PKZM4 mit Zuordnungsart „1“ und „2“

16	150	150	25	N	150	150	25	N	45	45	25	100	15	15	100	8	8	2,5	100
25	150	150	25	N	150	150	25	N	45	45	25	100	15	15	100	8	8	2,5	100
32	50	50	25	100	50	50	25	100	45	45	25	100	15	15	100	5	5	2,5	100
40	50	50	25	100	50	50	25	100	45	45	25	100	15	15	100	5	5	2,5	100
50	50	50	25	100	50	50	25	100	45	45	25	100	15	15	100	5	5	2,5	100
58	50	50	25	160	50	50	25	160	45	45	25	160	15	15	160	5	5	2,5	160
63	50	50	25	160	50	50	25	160	45	45	25	160	15	15	160	5	5	2,5	160

Hinweise

- Kein vorgeschaltetes Schutzorgan notwendig, da eigenfester Bereich (150 kA)
- N Nicht erforderlich

- 1) Sicherung (A gG/gL) zur Erhöhung des Schaltvermögens des Motorschutzschalters auf 100 kA
- 2) Weitere Informationen zu Spannungen >400 V und Gerätekombination mit CL-PKZ0 auf Anfrage.

Innenwiderstände Motorschutzschalter

	Impedanz	Stromwärme verluste (3-polig betriebs- warm)	Bemes- sungsdauer- strom I_u
	Ω		
PKZM0-0,16	78	6	0,16
PKZM0-0,25	32	6	0,25
PKZM0-0,4	13	6	0,4
PKZM0-0,63	5	6	0,63
PKZM0-1	2	6	1
PKZM0-1,6	0,8	6	1,6
PKZM0-2,5	0,32	6	2,5
PKZM0-4	0,13	6	4
PKZM0-6,3	0,050	6	6,3
PKZM0-10	0,020	6	10
PKZM0-12	0,014	6	12
PKZM0-16	0,008	6	16
PKZM0-20	0,005	6	20
PKZM0-25	0,003	6	25
PKZM0-32	0,002	6	32

	Impedanz	Stromwärme verluste (3-polig betriebs- warm)	Bemes- sungsdauer- strom I_u
	Ω		
PKZM4-16	0,029	22	16
PKZM4-25	0,012	22	25
PKZM4-32	0,007	22	32
PKZM4-40	0,005	22	40
PKZM4-50	0,003	22	50
PKZM4-58	0,002	22	58
PKZM4-63	0,002	22	65

Schaltvermögen Motorschutzschalter, Motorstarterkombinationen

Bemessungsdauerstrom I_u Bedingter Bemessungskurzschlussstrom I_q IEC/EN 60947-4-1Bemessungsgrenzkurzschlussausschaltvermögen I_{cu} IEC/EN 60947-2Bemessungsbetriebskurzschlussausschaltvermögen I_{cs} IEC/EN 60947-2

I_u A	230/400 V			415 V			440 V			500 V			525 V			690 V		
	I_q kA	I_{cu} kA	I_{cs} kA	I_q kA	I_{cu} kA	I_{cs} kA	I_q kA	I_{cu} kA	I_{cs} kA	I_q kA	I_{cu} kA	I_{cs} kA	I_q kA	I_{cu} kA	I_{cs} kA	I_q kA	I_{cu} kA	I_{cs} kA
PKE12/XTU(A)-... mit Zuordnungsart „1“ und „2“																		
1,2	100			50			15			10			10			3		
4	100			50			50			10			10			3		
12	100			50			20			20			10			3		
PKE32/XTU(A)-... mit Zuordnungsart „1“ und „2“																		
32	100			50			25			6			3			3		
PKE32/XTUCP(A)-... mit Zuordnungsart „1“ und „2“																		
36	-	50	12,5	-			-			-			-			-		
PKE65/XTU(W)(A) mit Zuordnungsart „1“ und „2“																		
32 - 65	80			80			45			15			10			5		
Motorstarterkombinationen MSC-DE(A)-...-M7(12)... mit Zuordnungsart „1“																		
1,2	100			50			15			10			-			-		
4	100			50			50			50			-			-		
12	100			50			50			20			-			-		
Motorstarterkombinationen MSC-DE(A)-...-M17(32)... mit Zuordnungsart „1“																		
12	100			65			65			35			35			3		
32	100			100			65			50			5			5		
Motorstarterkombinationen MSC-DE(A)-...-M17(32)... mit Zuordnungsart „2“																		
1,2	100			65			65			10			3			3		
4	100			65			65			50			3			3		
12	100			65			65			50			35			3		
32	100			100			65			50			35			3		
PKE12/XTU-...+DILM17+CL-PKZ0 mit Zuordnungsart „2“																		
1,2 - 12	100			100			100			100			-			-		
PKE32/XTU-32+DILM32+CL-PKZ0 mit Zuordnungsart „2“																		
32	100			100			100			100			-			-		
PKE65/XTU(A)-65+DILM(40, 50)65 mit Zuordnungsart „2“																		
65	80			50			50			50			10			10		



Approbationen für den Weltmarkt

Approbierte Leistungsdaten ¹⁾ UL 508/CSA C 22.2 No. 14	Maximale Motorleistung Drehstrom HP = PS				Einstellbereiche		Maximales Schutzorgan nach UL/CSA Gruppenschutz ²⁾					
					Überlast- auslöser	Kurzschluss- auslöser	bis max. Kurzschluss- strom		Maximale Sicherung		Maximaler Leistungs- schalter	
	200 V	230 V	460 V	575 V	A	A	600 V	mit CL	mit CL	mit CL	mit CL	
HP	HP	HP	HP	A	A	kA	kA	A	A	A	A	
Motorschutzschalter PKZM01	„Manual Motor Starter with thermal and magnetic trip“											
PKZM01-0,16	3)				0,1 – 0,16	2,2	50		600	600		
PKZM01-0,25	3)				0,16 – 0,25	3,4	50		600	600		
PKZM01-0,4	3)				0,25 – 0,4	5,6	50		600	600		
PKZM01-0,63	3)				0,4 – 0,63	8,8	50		600	600		
PKZM01-1	3)				0,63 – 1	14	50		600	600		
PKZM01-1,6			¾	¾	1 – 1,6	22	50		600	600		
PKZM01-2,5	½	½	1	1½	1,6 – 2,5	35	50		600	600		
PKZM01-4	¾	¾	2	3	2,5 – 4	56	50		600	600		
PKZM01-6,3	1	1½	3	5	4 – 6,3	88	50		600	600		
PKZM01-10	3	3	7½	10	6,3 – 11	140	22	50	150	600	125	600
PKZM01-12	3	3	7½	10	9 – 12	168	18	50	150	600	125	600
PKZM01-16	3	5	10	10	10 – 16	224	10	50	150	600	125	600
PKZM01-20	5	-	-	15	16 – 20	280	10	18	150	600	125	600
PKZM01-25	-	7½	15	20	20 – 25	350	10	18	150	600	125	600
Motorschutzschalter PKZM0	„Manual Motor Starter with thermal and magnetic trip“											
PKZM0-0,16	3)				0,1 – 0,16	2,2	50		600	600		
PKZM0-0,25	3)				0,16 – 0,25	3,4	50		600	600		
PKZM0-0,4	3)				0,25 – 0,4	5,6	50		600	600		
PKZM0-0,63	3)				0,4 – 0,63	8,8	50		600	600		
PKZM0-1	3)				0,63 – 1	14	50		600	600		
PKZM0-1,6			¾	¾	1 – 1,6	22	50		600	600		
PKZM0-2,5	½	½	1	1½	1,6 – 2,5	35	50		600	600		
PKZM0-4	¾	¾	2	3	2,5 – 4	56	50		600	600		
PKZM0-6,3	1	1½	3	5	4 – 6,3	88	50		600	600		
PKZM0-10	3	3	7½	10	6,3 – 11	140	22	50	150	600	125	600
PKZM0-12	3	3	7½	10	9 – 12	168	18	50	150	600	125	600
PKZM0-16	3	5	10	10	10 – 16	224	10	50	150	600	125	600
PKZM0-20	5	-	-	15	16 – 20	280	10	18	150	600	125	600
PKZM0-25	-	7½	15	20	20 – 25	350	10	18	150	600	125	600
PKZM0-32	7½	10	20	25	24 – 32	448	10	18	150	600	125	600
Motorschutzschalter PKZM4												
PKZM4-16	3	5	10	15	10 – 16	224	50		600	600		
PKZM4-25	7½	7½	20	25	16 – 25	350	50		600	600		
PKZM4-32	10	10	25	30	25 – 34	448	50		600	600		
PKZM4-40	10	15	30	40	32 – 42	560	50		600	600		
PKZM4-50	10	15	30	40	40 – 52	700	10		600	600		
PKZM4-58	15	15	40	50	50 – 56	812	10		600	600		
PKZM4-63	15	15	40	50	52 – 58	882	10		600	600		

Hinweise

Service Factor (SF)

Einstellwert I_r der Stromskala in Abhängigkeit vom Belastungsfaktor $SF = 1,15 \rightarrow I_r = 1 \times I_{n\text{ mot}}$ $SF = 1 \rightarrow I_r = 0,9 \times I_{n\text{ mot}}$ ¹⁾ Weltgeräte IEC Δ UL/CSA²⁾ Achtung: Geänderte Anforderungen für Gruppenabsicherung³⁾ Motorleistung in diesem Bereich nach Bemessungsstrom berechnen. Angegebene Werte nach NEC Table 430 – 150

Approbierte Leistungsdaten ¹⁾ UL 508/CSA C 22.2 No. 14			verwendbar für	Pilot Duty	General Use	
Zusatzrüstung						
Normalhilfsschalter	NHI11-PKZ0	PKZM0(-T) PKZM4	A 600, Q 300	5 A – 600 V AC 1 A – 250 V DC	–	
	NHI12-PKZ0					
	NHI21-PKZ0					
	NHI2-11S-PKZ0					
	NHI-E-11-PKZ0					
	NHI-E-10-PKZ0		E150	0,5 A – 250 V AC	–	
Voreilender Hilfsschalter	VHI20-PKZ0	PKZM0(-T)	E150	0,5 A – 250 V AC	–	
	VHI20-PKZ01	PKZM01				
Ausgelöstmelder	AGM2-10-PKZ0	PKZM0(-T) PKZM4	A 600, Q 300	5 A – 600 V AC 1 A – 250 V DC	–	
	AGM2-01-PKZ0					
Spannungsauslöser	A-PKZ0(...)	PKZM0(-T) PKZM4	–	–	–	Betätigungsspannungen und Bestellangaben → Produkte für den deutschen Markt
	U-PKZ0(...)					
Hilfsschalter für Schaltantrieb	HI11-S/EZ-PKZ0	PKZM0	A 600, Q 300	5 A – 600 V AC 1 A – 250 V DC	–	

**Hinweise**¹⁾ Weltgeräte IEC = UL/CSA**Motorschutzschalter PKZM0(4), Einsatz als „Manual self-protected Motor Starters“ – UL 508 Type E**

Maximale Motorleistung Drehstrom HP = PS				Einstellbereiche		Interrupting Capacity = Short Circuit Current Rating SCCR			Komponenten					
200 V	230 V	460 V	575 V	Überlast- auslöser	Kurzschluss- auslöser	240 V	480Y/ 277 V ²⁾	600Y/ 347 V ²⁾	Motor Protector	Accessories				
208 V	240 V	480 V	600 V			[kA]	[kA]	[kA]	Typ	Typ				
[HP]	[HP]	[HP]	[HP]	[A]	[A]	[kA]	[kA]	[kA]						
¹⁾				0,1 – 0,16	2,2	65	65	50	PKZM0-0,16	BK25/3-PKZ0-E				
				0,16 – 0,25	3,4	65	65	50	PKZM0-0,25	BK25/3-PKZ0-E				
				0,25 – 0,4	5,6	65	65	50	PKZM0-0,4	BK25/3-PKZ0-E				
				0,4 – 0,63	8,8	65	65	50	PKZM0-0,63	BK25/3-PKZ0-E				
				0,63 – 1	14	65	65	50	PKZM0-1	BK25/3-PKZ0-E				
				1 – 1,6	22	65	65	50	PKZM0-1,6	BK25/3-PKZ0-E				
				1/2	1/2	1	1 1/2	1,6 – 2,5	35	65	65	50	PKZM0-2,5	BK25/3-PKZ0-E
				3/4	3/4	2	3	2,5 – 4	56	65	65	50	PKZM0-4	BK25/3-PKZ0-E
				1	1 1/2	3	5	4 – 6,3	88	65	65	50	PKZM0-6,3	BK25/3-PKZ0-E
				3	3	7 1/2	10	6,3 – 11	140	65	65	50	PKZM0-10	BK25/3-PKZ0-E
3	3	7 1/2	–	9 – 12	168	65	65	–	PKZM0-12	BK25/3-PKZ0-E				
3	5	10	–	10 – 16	224	42	42	–	PKZM0-16	BK25/3-PKZ0-E				
5	–	–	–	16 – 20	280	18	18	–	PKZM0-20	BK25/3-PKZ0-E				
–	7 1/2	15	–	20 – 25	350	18	18	–	PKZM0-25	BK25/3-PKZ0-E				
7 1/2	10	20	–	24 – 32	448	18	18	–	PKZM0-32	BK25/3-PKZ0-E				
3	5	10	10	10 – 16	224	65	65	25	PKZM4-16	BK50/3-PKZ4-E				
5	7 1/2	15	20	16 – 27	350	65	65	25	PKZM4-25	BK50/3-PKZ4-E				
7 1/2	10	20	30	24 – 34	448	65	65	25	PKZM4-32	BK50/3-PKZ4-E				
10	–	30	30	32 – 40	560	65	65	25	PKZM4-40	BK50/3-PKZ4-E				
–	15	30	–	40 – 52	700	65	65	–	PKZM4-50	BK50/3-PKZ4-E				
–	–	40	–	50 – 56	812	65	65	–	PKZM4-58	BK50/3-PKZ4-E				
–	–	40	–	52 – 58	882	65	–	–	PKZM4-63	BK50/3-PKZ4-E				

Hinweise¹⁾ Motorleistung in diesem Bereich nach Bemessungsstrom berechnen. Angegebene Werte nach NEC Table 430 -150²⁾ Geeignet für sternpunktgeerdete Netze

Technische Daten

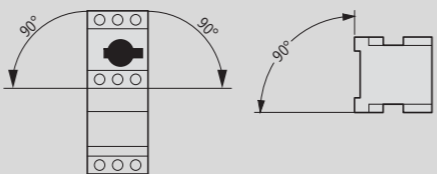
			PKZM01...	PKZM0-... ¹⁾
Allgemeines				
Normen und Bestimmungen			IEC/EN 60947, VDE 0660, UL 508, CSA C 22.2 No. 14	
Klimafestigkeit			Feuchte Wärme, konstant nach IEC 60068-2-78 Feuchte Wärme, zyklisch nach IEC 60068-2-30	
Umgebungstemperatur	Lagerung	°C	-25...80	-25...80
	offen	°C	-25...55	-25...55
	gekapselt	°C	-25...40	-25...40
Einbaulage				
Energie-Einspeisrichtung			beliebig	beliebig
Schutzart	Gerät		IP20	IP20
	Anschlussklemmen		IP00	IP00
Berührungsschutz nach EN 50274			finger- und handrücksicher	
Schockfestigkeit Halbsinusstoß 10 ms nach IEC 60068-2-27			g	25
Aufstellungshöhe			m	max. 2000
Anschlussquerschnitte Schraubklemme	eindrätig	mm ²	1 x (1 - 6) 2 x (1 - 6)	1 x (1 - 6) 2 x (1 - 6)
	feindrätig mit Aderendhülse nach DIN 46228	mm ²	1 x (1 - 6) 2 x (1 - 6)	1 x (1 - 6) 2 x (1 - 6)
	ein- oder mehrdrätig	AWG	18 - 10	18 - 10
Anzugsdrehmoment Anschlussschrauben	Hauptleiter	Nm	1,7	1,7
	Hilfsleiter	Nm	1	1
Hauptstrombahnen				
Bemessungsstoßspannungsfestigkeit		U_{imp}	V AC	6000
Überspannungskategorie/Verschmutzungsgrad				III/3
Bemessungsbetriebsspannung		U_e	V AC	690
Bemessungsdauerstrom = Bemessungsbetriebsstrom		$I_u = I_e$	A	16 bzw. Einstellstrom des Überstromauslösers 32 bzw. Einstellstrom des Überstromauslösers
Bemessungsfrequenz			Hz	40 - 60
Stromwärmeverluste (3-polig betriebswarm)			W	6
Lebensdauer, mechanisch		Schaltspiele	x 10 ⁶	0,05
Lebensdauer, elektrisch (AC-3 bei 400 V)		Schaltspiele	x 10 ⁶	0,05
maximale Schaltfrequenz		Schaltspiele/h	S/h	25
Motorschaltvermögen				
AC-3 bis 690 V			A	16
Auslöser				
Temperaturkompensation			-5 - +40 (nach IEC/EN 60947, VDE 0660) -25 - +55 (Arbeitsbereich)	
Einstellbereich Überlastauslöser			0,6 - 1 x I_u	
Kurzschlussauslösertoleranz			± 20%	
Phasenausfallempfindlichkeit			IEC/EN 60947-1-1, VDE 0660 Teil 102	

Hinweise ¹⁾ geprüft nach IEC/EN 60947-1 (Trenneigenschaften) und IEC/EN 60947-2

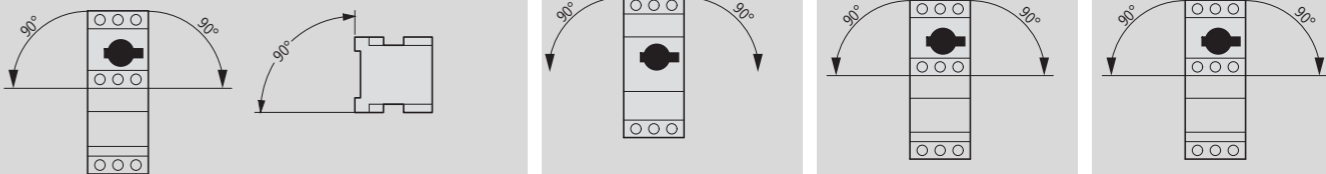
PKM0-...	PKZM0-...-T	PKZM4	PKE12..., PKE32...	PKE65...
IEC/EN 60947, VDE 0660, UL 508, CSA C 22.2 No. 14			IEC/EN 60947, VDE 0660	
Feuchte Wärme, konstant nach IEC 60068-2-78 Feuchte Wärme, zyklisch nach IEC 60068-2-30				
-25...80	-25...80	-25...70	-40 - +80	-40 - +80
-25...55	-25...55	-25...55	-25 - +55	-25 - +55
-25...40	-25...40	-25...40	-25 - +40	-25 - +40
				
beliebig	beliebig	beliebig	beliebig	beliebig
IP20	IP20	IP20	IP20	IP20
IP00	IP00	IP00	IP00	IP00
finger- und handrücksicher				
25	25	15	25	25
max. 2000	max. 2000	max. 2000	max. 2000	max. 2000
1 x (1 - 6) 2 x (1 - 6)	1 x (1 - 6) 2 x (1 - 6)	1 x (1 - 50) 2 x (1 - 35)	1 x (1 - 6) 2 x (1 - 6)	1 x (0,75 - 16) 2 x (0,75 - 16)
1 x (1 - 6) 2 x (1 - 6)	1 x (1 - 6) 2 x (1 - 6)	1 x (1 - 35) 2 x (1 - 35)	1 x (1 - 6) 2 x (1 - 6)	1 x (0,75 - 35) 2 x (0,75 - 25)
18 - 10	18 - 10	14 - 2	14 - 10	14 - 2
1,7	1,7	3,3	1,7	3,3
1	1	1	1	1
6000	6000	6000	6000	6000
III/3	III/3	III/3	III/3	III/3
690	690	690	690	690
32 bzw. Einstellstrom des Überstromauslösers	25 bzw. Einstellstrom des Überstromauslösers	65 offen 63 gekapselt	12 A bzw. Einstellstrom des Überlastauslösers 32 A bzw. Einstellstrom des Überlastauslösers	65 A bzw. Einstellstrom des Überlastauslösers
40 - 60	40 - 60	40 - 60	40 - 60	40 - 60
6	6	22	6 (mit PKE-XTU(A)-32) 3,5 (mit PKE-XTU(A)-12) 0,5 (mit PKE-XTU(A)-4) 0,4 (mit PKE-XTU(A)-1,2)	22 (mit PKE65-XTU(A)-65) 6 (mit PKE-XTUW(A)-32)
0,1	0,1	0,03	0,05	0,05
0,1	0,1	0,03	0,05	0,05
40	40	40	60	60
32	25	65	12 32	65
-5 - +40 (nach IEC/EN 60947, VDE 0660) -25 - +55 (Arbeitsbereich)				
0,6 - 1 x I_u	0,6 - 1 x I_u	0,6 - 1 x I_u	0,25 - 1 x I_u	0,25 - 1 x I_u
± 20%	± 20%	± 20%	± 20%	± 20%
-	IEC/EN 60947-1-1, VDE 0660 Teil 102	IEC/EN 60947-4-1, VDE 0660 Teil 102	ja	ja

				NHI...PKZO	NHI-E-...PKZO	VHI...PKZO	AGM
Hilfsschalter							
Bemessungsstoßspannungsfestigkeit	U_{imp}	V AC		6000	4000	4000	6000
Überspannungskategorie/Verschmutzungsgrad				III/3	III/3	III/3	III/3
Bemessungsbetriebsspannung							
	U_e	V AC		500	440	440	500
	U_e	V DC		250	250	250	250
Sichere Trennung nach EN 61140							
zwischen Hilfskontakten und Hauptstrombahnen		V AC		690	690	690	690
Bemessungsbetriebsstrom							
AC-15							
220 - 240 V	I_e	A		3,5	1	1	3,5
380 - 415 V	I_e	A		2	–	–	2
440 - 500 V	I_e	A		1	–	–	1
DC-13 L/R \leq 100 ms							
24 V	I_e	A		2	2	2	2
60 V	I_e	A		1,5	–	–	1,5
110 V	I_e	A		1	–	–	1
220 V	I_e	A		0,25	–	–	0,25
Lebensdauer							
Lebensdauer, mechanisch	Schaltspiele	$\times 10^6$		> 0,1	> 0,1	> 0,1	> 0,01
Lebensdauer, elektrisch	Schaltspiele	$\times 10^6$		> 0,05	> 0,1	> 0,1	> 0,05
Kontaktzuverlässigkeit (bei $U_e = 24$ V DC, $U_{min} = 17$ V, $I_{min} = 5.4$ mA)	Ausfallrate	λ		< $10^{-8} < 1$ Ausfall auf 1×10^8 Schaltungen			
zwangsgeführte Kontakte				ja	–	–	–
Kurzschlussfestigkeit ohne Verschweißen							
sicherungslos				FAZ-B4/1-HI	–	–	FAZ-B4/1-HI
Schmelzsicherung		A gG/gL		10	10	10	10
Anschlussquerschnitte							
ein- oder feindrätig mit Aderendhülse		mm ²		0.75 - 2.5	0.75 - 1.5	0.75 - 1.5	0.75 - 2.5
ein- oder mehrdrätig		AWG		18 - 14	18 - 16	18 - 16	18 - 14

				Unterspannungsauslöser U-PKZ...	Arbeitsstromauslöser A-PKZ...
Allgemeines					
Anschlussquerschnitte					
ein- oder feindrätig mit Aderendhülse		mm ²		1 x (0.75 - 2.5) 2 x (0.75 - 2.5)	1 x (0.75 - 2.5) 2 x (0.75 - 2.5)
ein- oder mehrdrätig		AWG		1 x (18 - 14) 2 x (18 - 14)	1 x (18 - 14) 2 x (18 - 14)
Hauptstrombahnen					
Bemessungsbetriebsspannung	U_e	V AC		42 - 480	42 - 480
Bemessungsbetriebsspannung	U_e	V DC		24 - 250	24 - 250
Anzugs-/Abfallspannung					
Anzugsspannung	$x U_s$			0,85 - 1,1	
Abfallspannung	$x U_s$			0,7 - 0,35	
Arbeitsbereich					
Wechselspannung		$x U_s$			0,7...1,1
Gleichspannung (Kurzzeitbetrieb 5 s)		$x U_s$			0,7...1,1
Leistungsaufnahme					
Wechselspannung					
Anzugsleistung AC	Anzug	VA		5	5
Halteleistung AC	Halten	VA		3	3
Gleichspannung					
Anzugsleistung DC	Anzug	W		–	3
Halteleistung DC	Halten	W		–	3

Abmessungen

Motorschutzschalter
PKZM01...

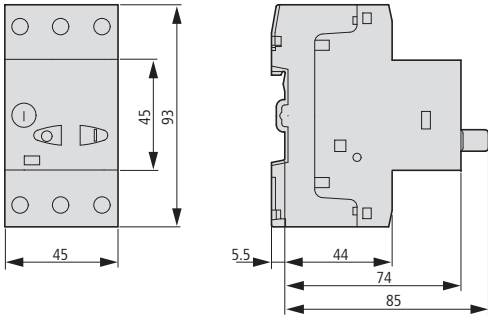

Motorschutzschalter
Transformatorschutzschalter
Motorschutzschalter mit Normalhilfsschalter
PKZM0-...(+NHI-E-...-PKZ0)
PKZM0-...-T(+NHI-E-...-PKZ0)
PKM0-...(+NHI-E-...-PKZ0)

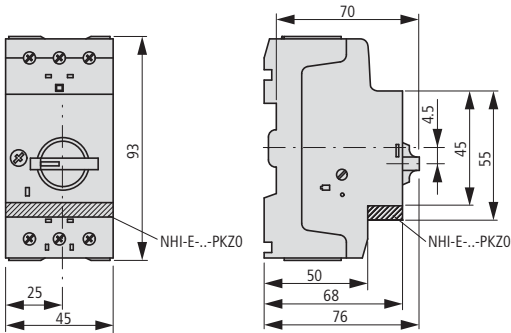

Motorschutzschalter mit abschließbarem Drehnebel

PKZM0-...+AK-PKZ0

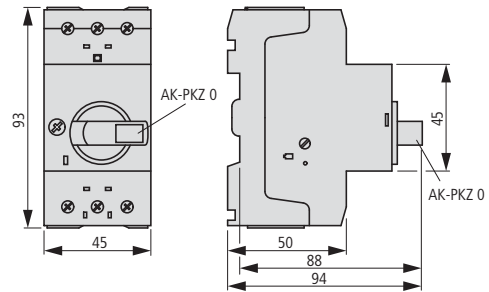

Strombegrenzer
CL-PKZ...

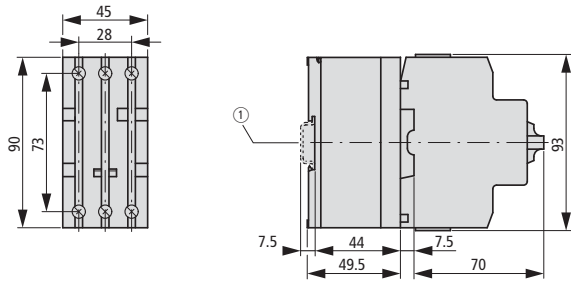

Motorschutzschalter mit voreilendem Hilfsschalter
PKZM0-...+VHI-...-PKZ0

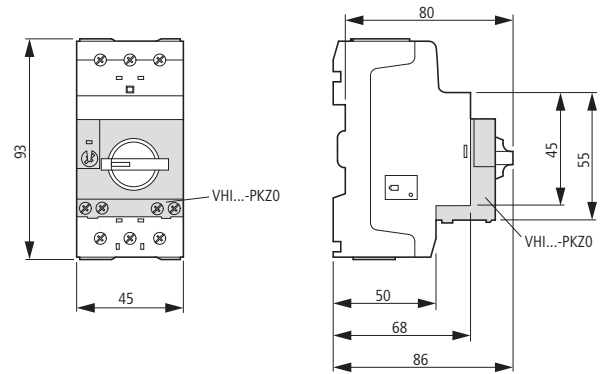

① Hutschiene IEC/EN 60715

Normalhilfsschalter

NHI-...-PKZ0

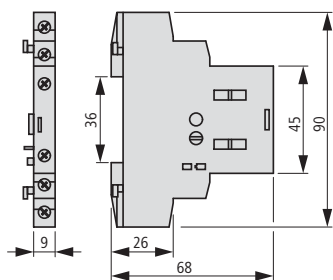

Ausgelöstmelder

AGM2-...-PKZ0

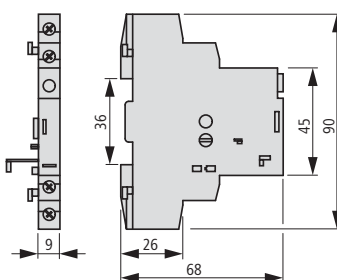

Arbeitsstromauslöser

Unterspannungsauslöser

A-PKZ0...

U-PKZ0...

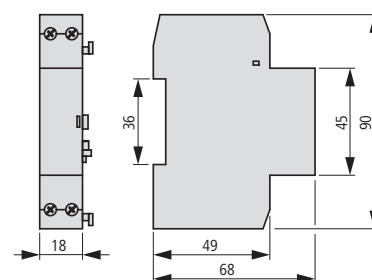

BBA0-25
 BBA0-25/2TS
 BBA0/2TS-L
 BBA0-32
 BBA0-32/2TS-C
 BBA0C-16

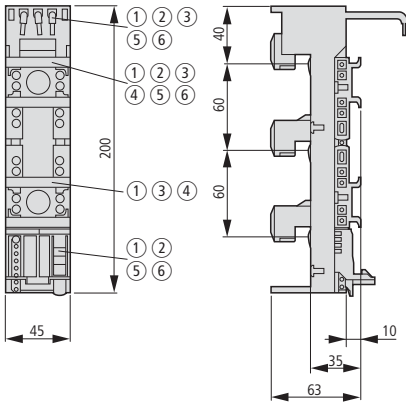

- ① BBA0-32/2TS-C
- ② BBA0-25/2TS
- ③ BBA0C-16
- ④ BBA0/2TS-L
- ⑤ BBA0-25
- ⑥ BBA0-32

BBA2-63
 BBA2-63/2TS

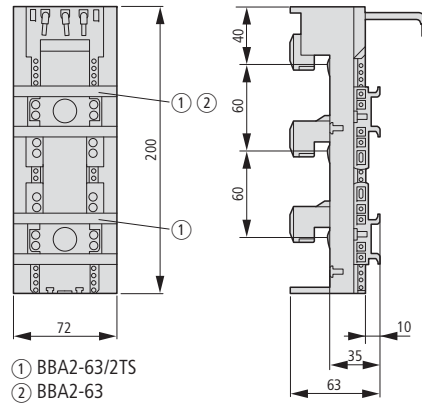

- ① BBA2-63/2TS
- ② BBA2-63

BBA4/2TS-L
 BBA4L-63

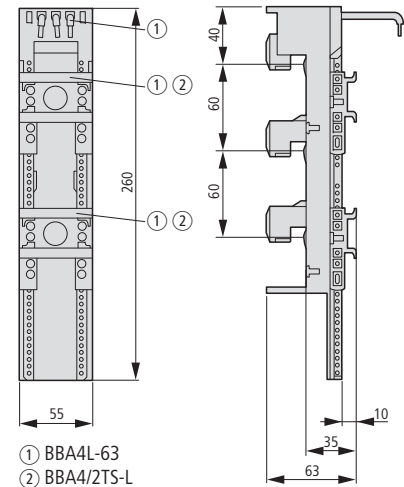

- ① BBA4L-63
- ② BBA4/2TS-L

BBA4-63

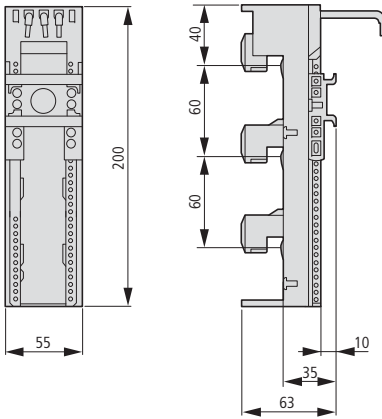

BBA2-80/2TS-S

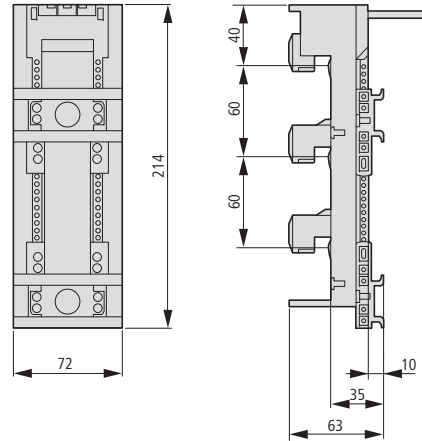

BBA2L-63

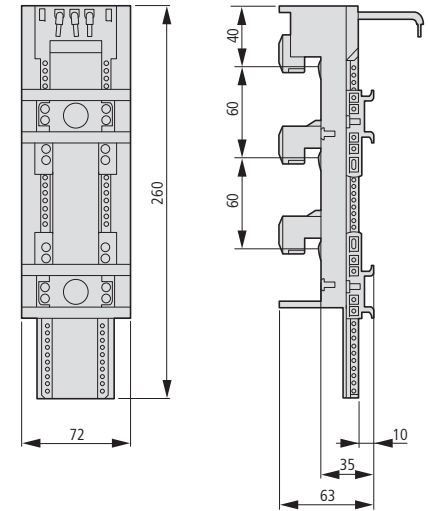

BBA0L-25
 BBA0L-32

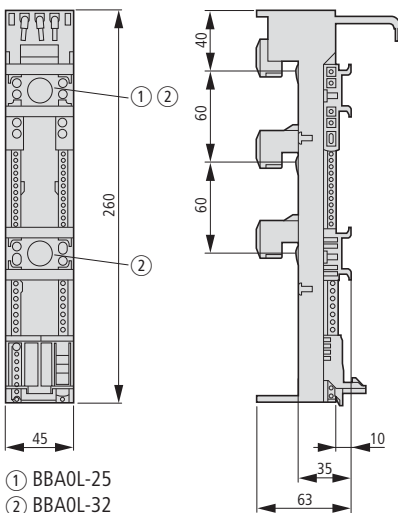

- ① BBA0L-25
- ② BBA0L-32

BBA0K-32

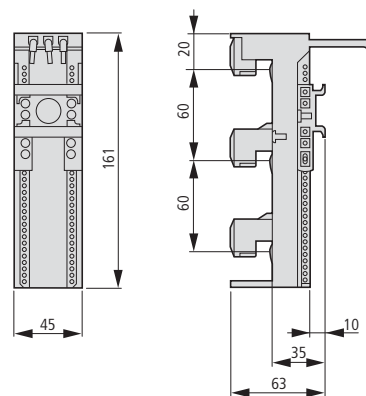

PKZM0-XC45L
 PKZM0-XC45L-2

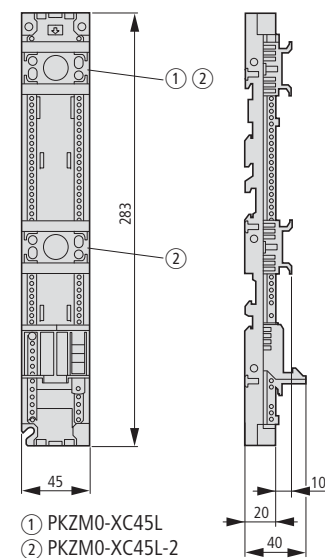

- ① PKZM0-XC45L
- ② PKZM0-XC45L-2

Isolierstoffgehäuse für den Aufbau

CI-PKZ0-M

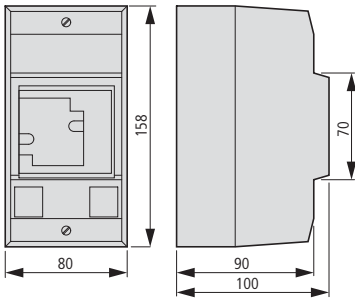

CI-PKZ10G...M

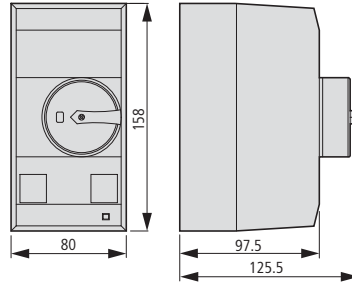

CI-PKZ0...M
+ SVB-PKZ0-CI

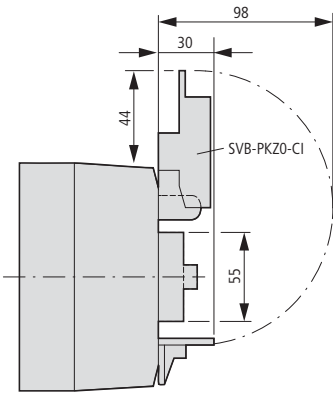

Bohrmaße
CI-PKZ0...M

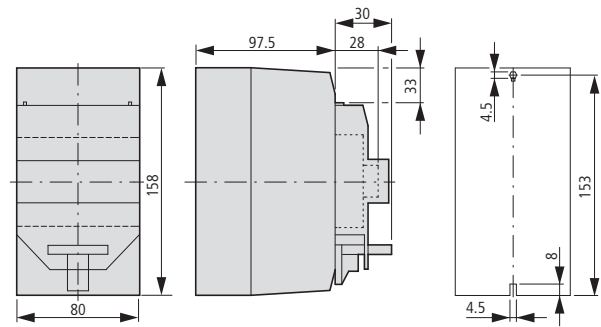

CI-K2-PKZ0

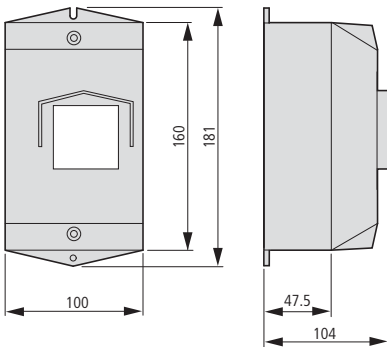

CI-K2-PKZ0G(R)(V)

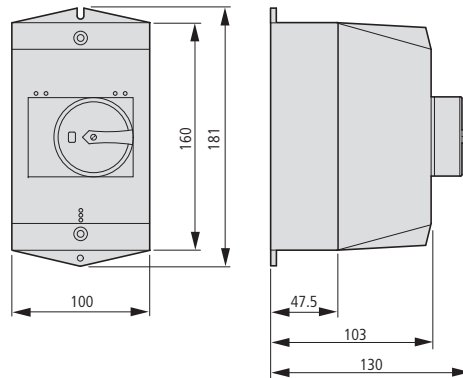

CI-K2-PKZ0-G(R)(V)
+ SVB-PKZ0-CI

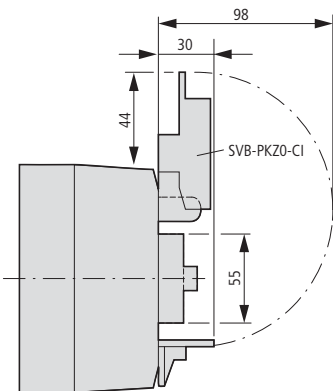

Bohrmaße
CI-K2-PKZ0...

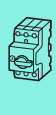
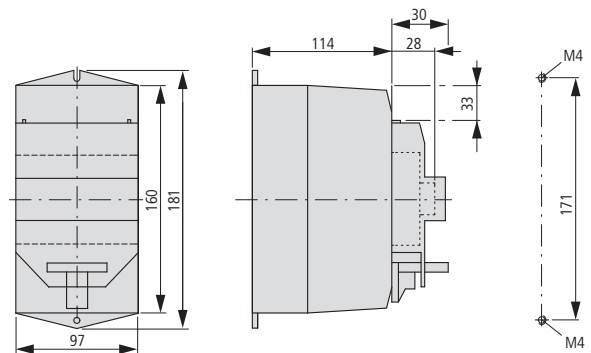

Türkupplungsgriffe

PKZO-X(R)H...

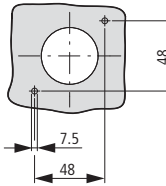
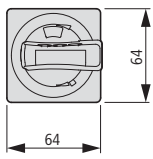

Einbautiefe: 100 bis 240 mm von der Oberkante DIN-Hutschiene bis Vorderkante Schranktür/Deckel
Abstand Schalterachse/Deckelscharnier: mindestens 100 mm

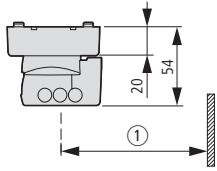

① mindestens 100 mm bis Deckelscharnier

Isolierstoffgehäuse für den Einbau

E-PKZO E-PKZO-G...

Einbauöffnung E-PKZO...

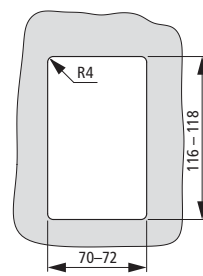
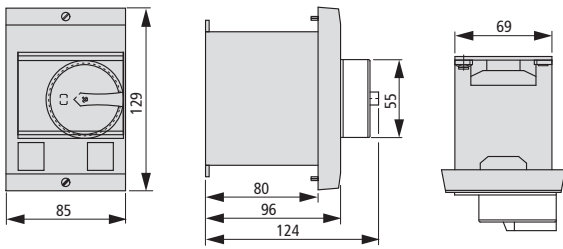

E-PKZO-G... + SVB-PKZO-E

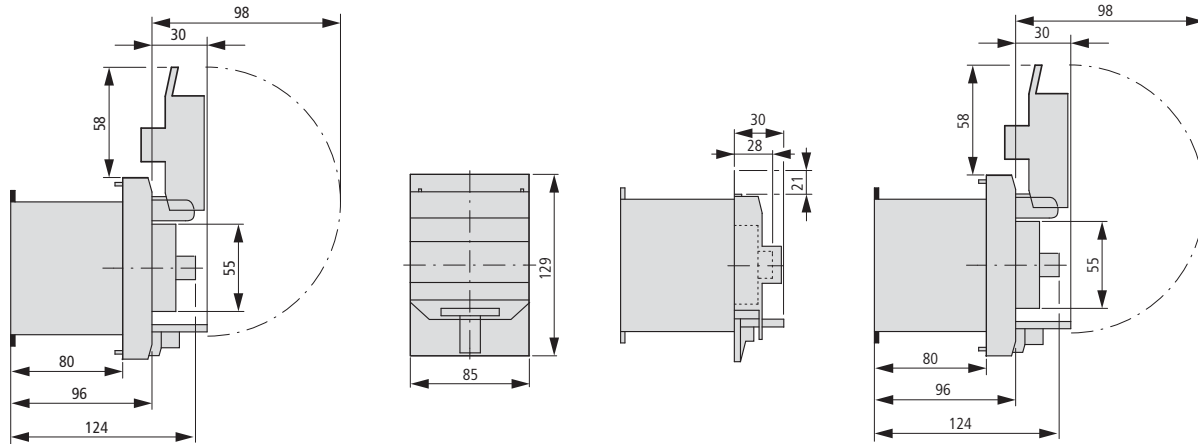

Isolierstoffgehäuse für den Aufbau

CI23E...

Montageplatten

M3-CI23

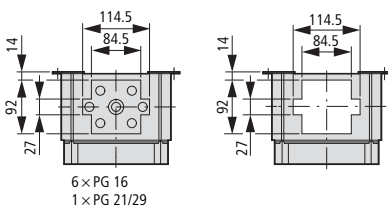
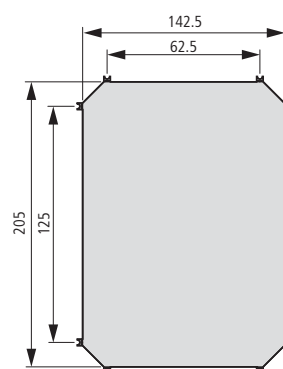
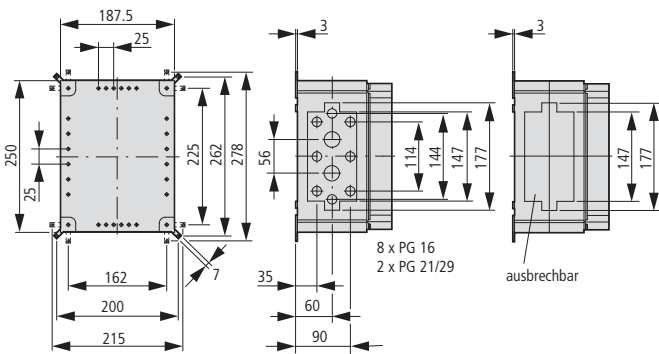

Isolierstoffgehäuse für den Aufbau

CI-PKZ01
CI-PKZ01-G

CI-PKZ01-PVT
CI-PKZ01-PVS

CI-PKZ01-SVB
CI-PKZ01-SVB-V

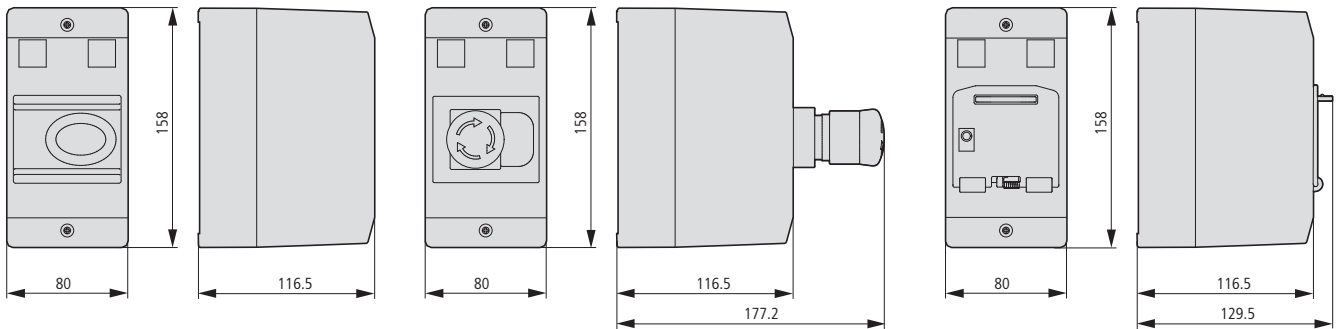

Isolierstoffgehäuse für den Einbau

E-PKZ01
E-PKZ01-G

E-PKZ01-PVT
E-PKZ01-PVS

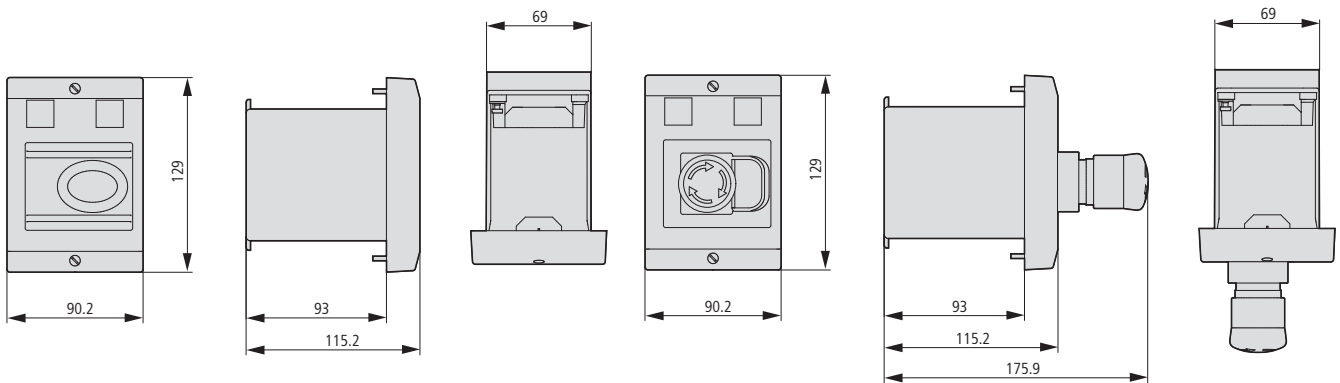

E-PKZ01-SVB
E-PKZ01-SVB-V

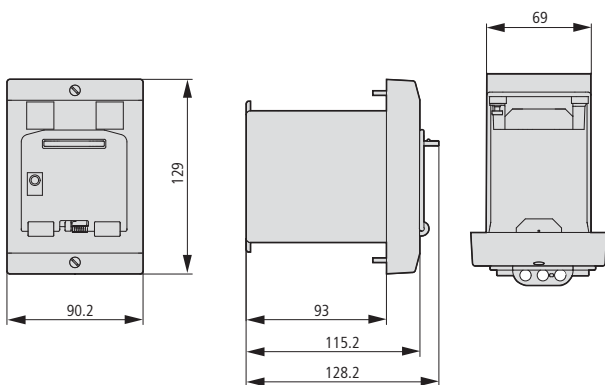

Motorschutzschalter

PKZM4-...

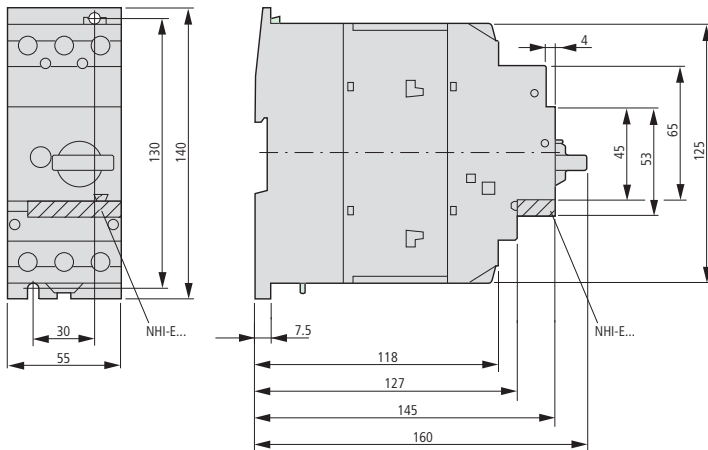
**Normalhilfsschalter**

NHI...-PKZ...

NHI...-PKZ0

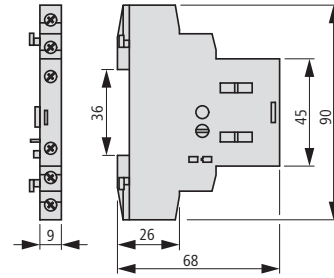
**Motorschutzschalter mit abschließbarem Deckel**

PKZM4-... +AK-PKZ0

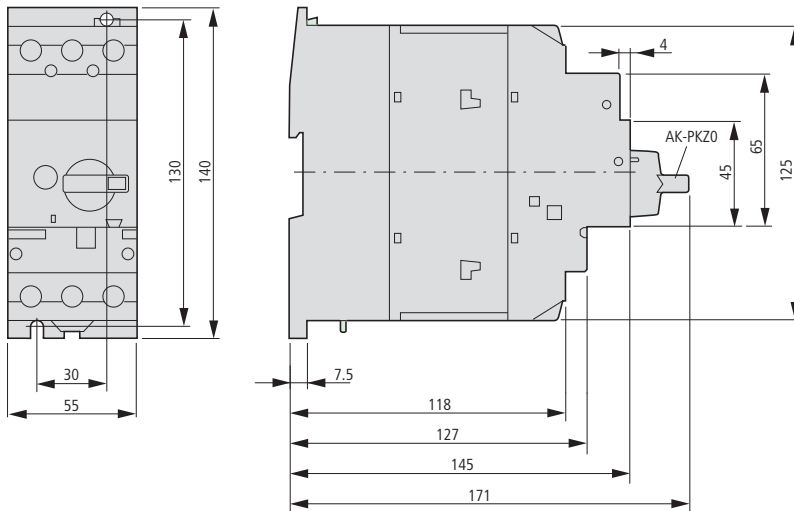
**Ausgelöstmelder**

AGM2...-PKZ...

AGM2...-PKZ0

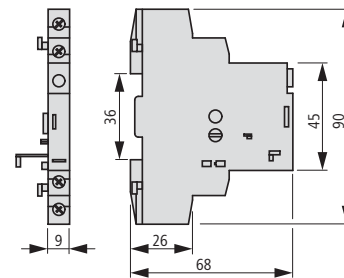

Drehstromschienenblock

B3.0/4-PKZ4

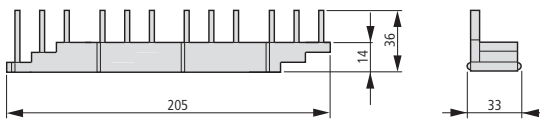

B3.2/4-PKZ4

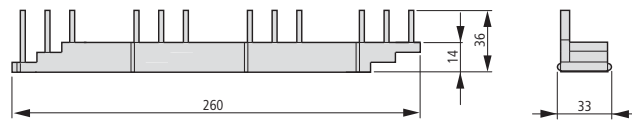

B3.0/3-PKZ4

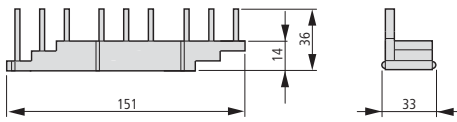

B3.2/2-PKZ4

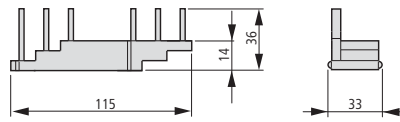

B3.0/2-PKZ4

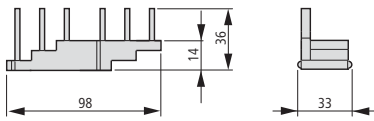

B3.1/3-PKZ4

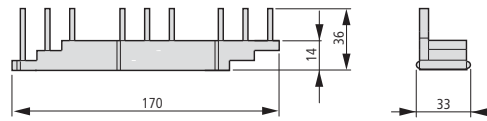

B3.1/4-PKZ4

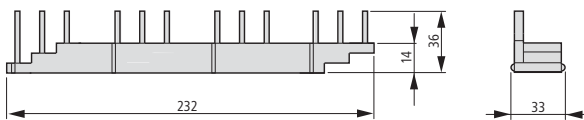

B3.1/2-PKZ4

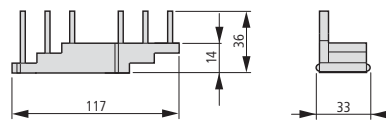

Drehstromschienenblöcke

B3.0/4-PKZ0

B3.0/2-PKZ0

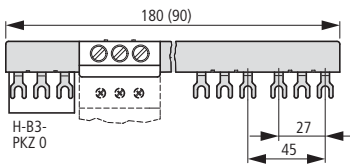

Drehstromschienenblöcke

B3.2/4-PKZ0

B3.2/2-PKZ0

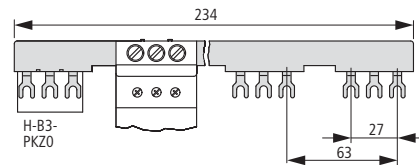

Drehstromschienenblöcke

B3.1/5-PKZ0

B3.1/3-PKZ0

B3.1/4-PKZ0

B3.1/2-PKZ0

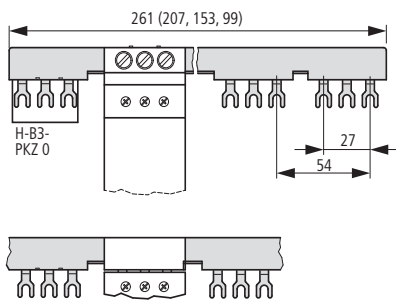

Einspeiseklemme

BK25/3-PKZ0

Überlappende Montage zur Verlängerung des Stromschienenblocks

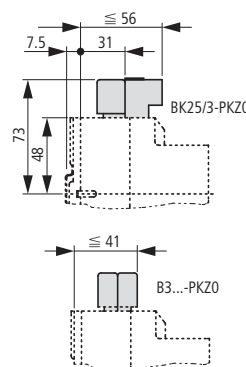

Motorstecker DILM12-XMCP/T

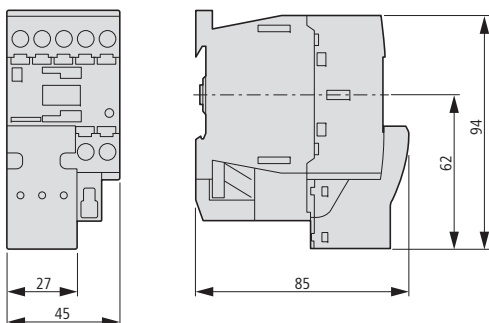

Isolierstoffgehäuse für den Aufbau

CI-K4-PKZ4-G(R)

+SVB-PKZ4-CI

CI-K4-PKZ4-G

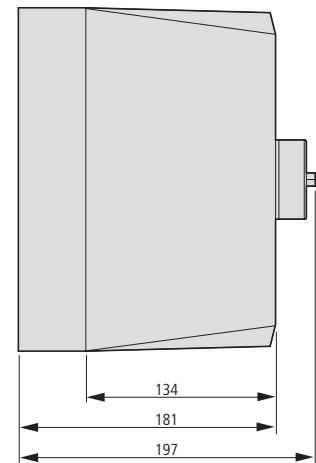
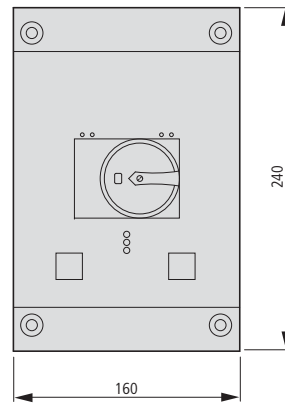
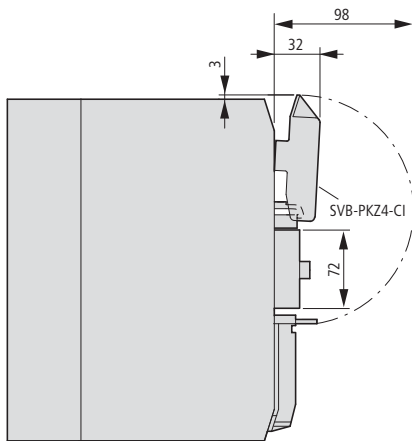
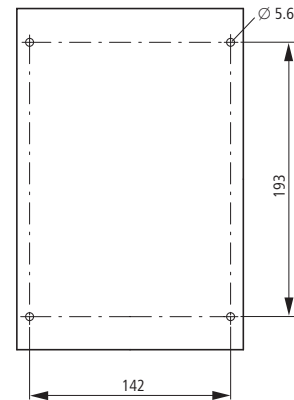
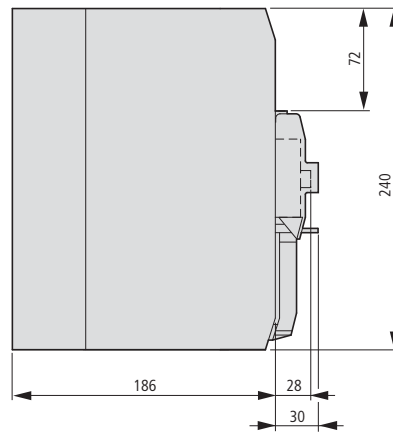
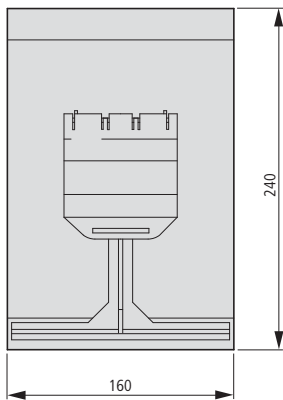
Bohrmaße
CI-K4-PKZ4-G(R)

Abmessungen

Motorschutzschalter

Komplettgerät mit Standardknebel
 Komplettgerät mit abschließbarem Drehknebel AK
 PKE12
 PKE32

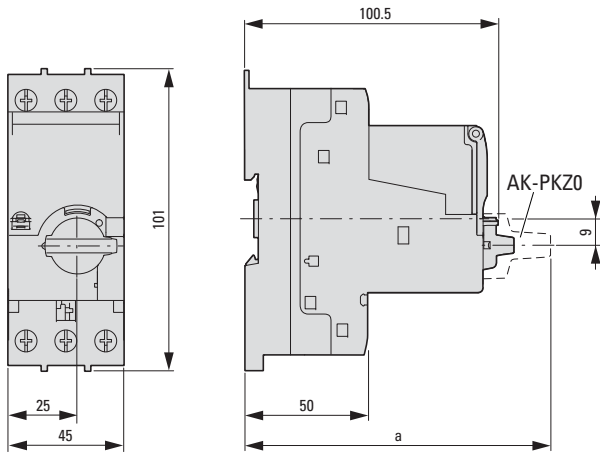

Typ	a
PKE12/...	102.5
PKE12/AK...	120.5
PKE32/...	102.5
PKE32/AK...	120.5

PKE65

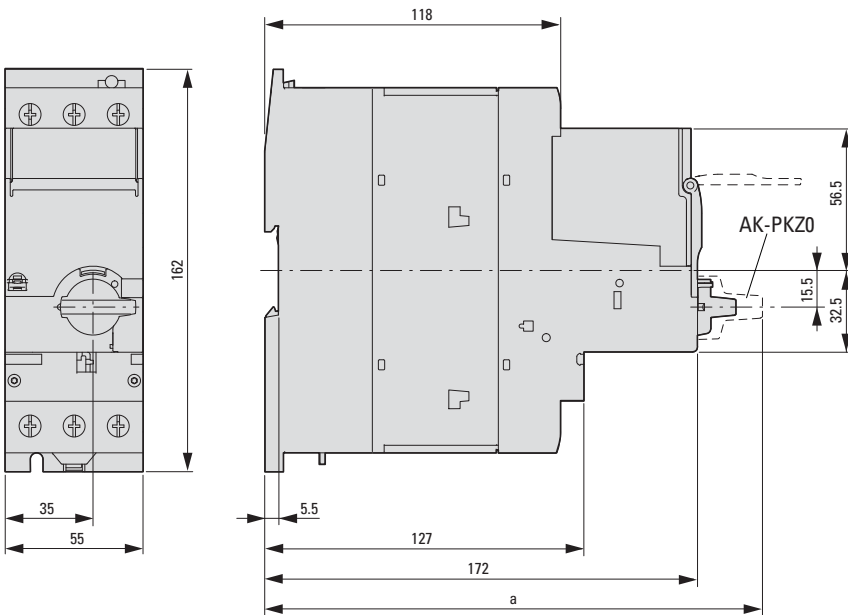

Typ	a
PKE65/...	187
PKE65/AK...	198

SmartWire-DT PKE-Modul (Motorstarterkombination)

PKE-SWD-32

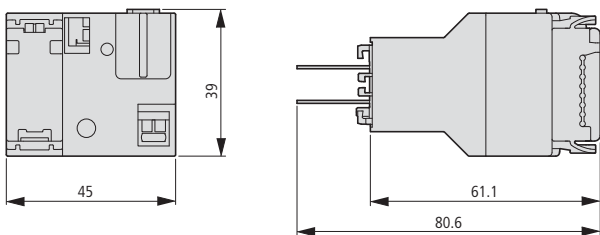

SmartWire-DT PKE-Modul (Motorschutzschalter)

PKE-SWD-SP

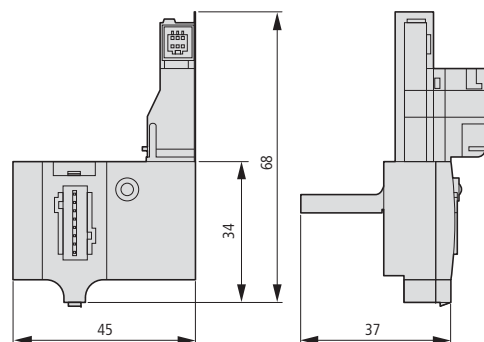

P-SOL, PKZ-SOL, SOL

Beschreibung

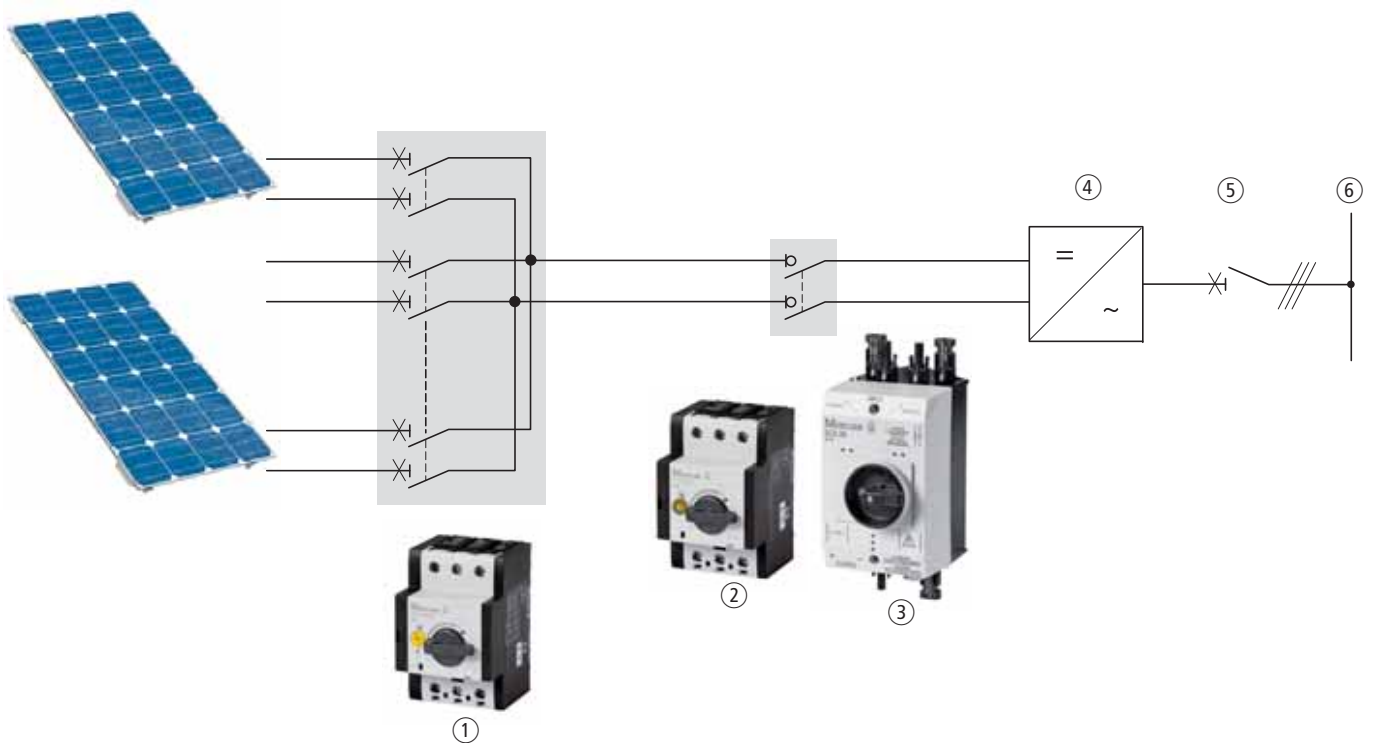

- ① DC-Strangenschutzschalter PKZ-SOL
- ② DC-Lasttrennschalter P-SOL
- ③ Einbaufertige DC-Lasttrennschalter SOL
- ④ Wechselrichter
- ⑤ AC-Hauptschalter
- ⑥ Netz

Beschreibung Photovoltaik

Photovoltaik-Anlagen wandeln das Sonnenlicht direkt in elektrische Energie um. Dazu werden Solarzellen eingesetzt. Photovoltaik ist eine erneuerbare Energiequelle, die auf privaten und öffentlichen Gebäuden sowie in Freifeldanlagen zum Einsatz kommt.

Es wird zwischen netzunabhängigen und netzgekoppelten Anlagen unterschieden. Netzkoppelte Photovoltaik-Anlagen speisen den erzeugten Strom direkt in das Stromnetz ein. Es entfällt dabei das aufwendige Zwischenspeichern. Eine solche Anlage besteht aus Solarzellen, einem oder mehreren Wechselrichtern und einer Schutzvorrichtung zum automatischen Abschalten bei Netzstörungen. Deshalb benötigen netzgekoppelte Photovoltaik-Anlagen sehr zuverlässige und sichere Einzelkomponenten.

Merkmale

DC-Strangenschutzschalter

- Schützen PV-Module vor Fehlerströmen, verhindern z. B. in größeren Anlagen das Rückspeisen von intakten Modulen auf ein Modul mit Kurzschluss.
- Sind nach einer Auslösung und Behebung der Auslösesursache sofort wieder betriebsbereit.
- Ungekapselt und für den Einbau in kundenspezifische Generator-Anschlusskästen vorgesehen.
- Auslöseströme sind in weiten Grenzen einstellbar.
- Optionale Arbeitsstrom- A-PKZO oder Unterspannungsauslöser U-PKZO ermöglichen eine Fernabschaltung, z. B. für die Feuerwehr. Optionaler Hilfsschalter NHI-E-PKZO signalisiert Schaltzustand.
- Bei Einbau in Kapselung für Spannungen bis 900 VDC geeignet.





























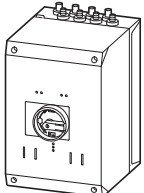

DC-Lasttrennschalter

- Gefordert nach Norm VDE 0100-712 (Juni 2006) zwischen PV-Modul und Wechselrichter.
- Gekapselte und offene (nach Einbau in Kapselung) Lasttrennschalter für Spannungen bis 1000 VDC.
- Verwendbar als separate Schaltstelle, wie in VDI-Richtlinie VDI 6012 gefordert, z. B. zum komplett gefahrlosen Spannungsfrei-Schalten eines defekten Wechselrichters.

- Schalten zweipolig, damit auch für ungeerdete Anlagen geeignet.
- TÜV-zertifiziert.
- Ungekapselte Lasttrennschalter P-SOL sind für den Einbau in kundenspezifische Gehäuse oder Wechselrichter vorgesehen.
- Separate Drehgriffe und Achsverlängerungen erlauben einen flexiblen Einbau.
- Für die Rückmeldung des Schaltzustandes lässt sich ein Hilfsschalterblock anbauen.
- Zur Fernauslösung steht ein Arbeitsstrom- oder Unterspannungsauslöser zur Verfügung.
- Lasttrennschalter SOL im Gehäuse sind einbaufertig. Varianten für 2 und 4 bzw. 4 und 8 Strings und für die gängigsten Steckerformen, wie MC3, MC4 oder metrische Verschraubungen, gestatten die problemlose Integration in verschiedene Anlagenkonzepte.
- Gehäuse realisiert die Schutzart IP65 und erlaubt somit auch eine Outdoor-Montage.
- Abschließbarkeit bietet Sicherheit im Servicefall.
- Druckausgleichselement verhindert Kondenswasserbildung und damit Ausfälle durch Spannungsüberschlag.

HPL07053DE

Bestellen

	Eingänge Anzahl der Stränge	Anschlussart	Ausgänge Anzahl der Stränge	Anschlussart	max. Bemessungs- betriebsstrom DC-21A I_e A	Typ Artikel-Nr.	Preis pro Stück Euro RG	VPE
DC-Lasttrennschalter, einbaufertig								
Bemessungsbetriebsspannung U_e 1000 V Schutzart IP65 Schutzklasse 2 2-polig								
	2	MC3	1	MC3	20	SOL20/2MC3 120913	a. A. F2	1 Stück  
	4	MC3	1	MC3	20	SOL20/4MC3 120914	a. A. F2	1 Stück  
	2	MC4	1	MC4	20	SOL20/2MC4 120915	227,00 F2	1 Stück  
	4	MC4	1	MC4	20	SOL20/4MC4 120916	257,00 F2	1 Stück  
	2	Verschraubung M12	1	Verschraubung M16	20	SOL20/2MV 120919	202,00 F2	1 Stück  
	2	MC3	1	MC3	30	SOL30/2MC3 120920	a. A. F2	1 Stück  
	4	MC3	1	MC3	30	SOL30/4MC3 120921	a. A. F2	1 Stück  
	2	MC4	1	MC4	30	SOL30/2MC4 120922	236,00 F2	1 Stück  
	4	MC4	1	MC4	30	SOL30/4MC4 120923	265,00 F2	1 Stück  
	2	Verschraubung M12	1	Verschraubung M16	30	SOL30/2MV 120926	210,00 F2	1 Stück  
		4	MC3	1	Verschraubung M20	63	SOL60/4MC3 120927	a. A. F2
8		MC3	1	Verschraubung M20	63	SOL60/8MC3 120928	a. A. F2	1 Stück  
4		MC4	1	Verschraubung M20	63	SOL60/4MC4 120929	a. A. F2	1 Stück  
8		MC4	1	Verschraubung M20	63	SOL60/8MC4 120930	a. A. F2	1 Stück  
4		Verschraubung M12	1	Verschraubung M20	63	SOL60/4MV 120933	a. A. F2	1 Stück  

Information relevant for export to North America







NA Certification Request filed for UL and CSA

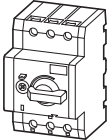

P-SOL, PKZ-SOL

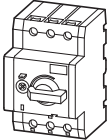
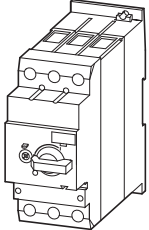
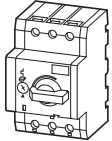
HPL07054DE

	max. Bemessungsbetriebsstrom DC-21A	zulässige Kurz- schlussströme der Solarmodule	Typ Artikel-Nr.	Preis pro Stück Euro RG	VPE
	I_e A				
DC-Lasttrennschalter, offen					
Bemessungsbetriebsspannung U_e 1000 V Schutzklasse II 2-polig					
	20		P-SOL20 120934	80,70 F2	1 Stück 
	30		P-SOL30 120935	84,40 F2	
	63		P-SOL60 120936	221,00 F2	
DC-Strangschutzschalter					
Bemessungsbetriebsspannung U_e 900 V Schutzklasse II 2-polig					
	12	5 - 9	PKZ-SOL12 120937	76,30 F2	1 Stück 
	20	9 - 15	PKZ-SOL20 120938	81,50 F2	
	30	15 - 22	PKZ-SOL30 120939	85,70 F2	

Hinweise

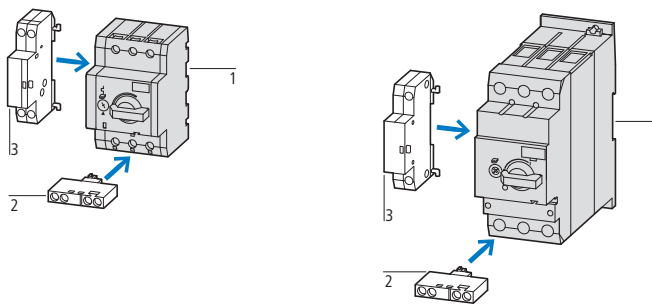

Zusatzausrüstungen

Seite

- 2 Hilfsschalter NHI-E → 7/12
- 3 Arbeitsstromauslöser A-PKZ0 → 7/31
- 3 Unterspannungsauslöser U-PKZ0 → 7/31

Information relevant for export to North America



NA Certification Request filed for UL and CSA

P-SOL, PKZ-SOL, SOL

Projektieren

Beschaltung P-SOL und PKZ-SOL

Lasttrennschalter P-SOL

Ungeerdetes Netz

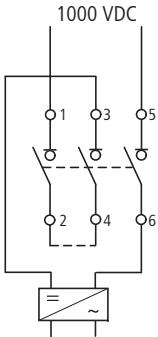

Geerdetes Netz

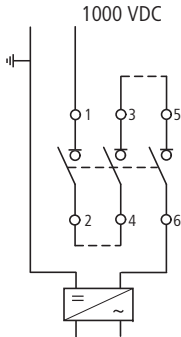

Strangschuttschalter PKZ-SOL

Ungeerdetes Netz

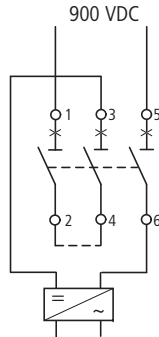

Geerdetes Netz

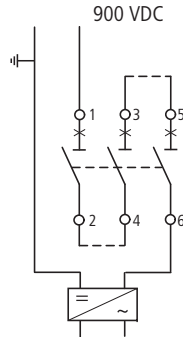

Innenschaltung SOL

SOL20/2MC3
SOL20/2MC4
SOL30/2MC3
SOL30/2MC4

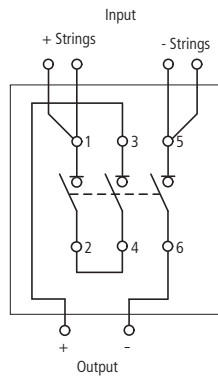

SOL20/2MV
SOL30/2MV

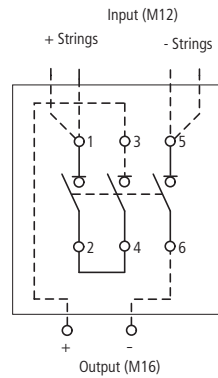

SOL20/4MC3
SOL20/4MC4
SOL30/4MC3
SOL30/4MC4

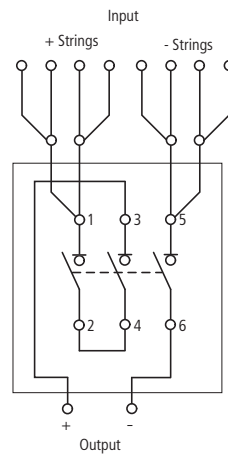

SOL60/4MC3
SOL60/4MC4

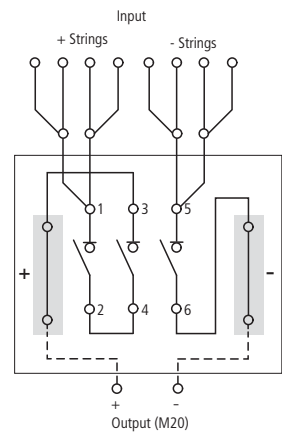

SOL60/4MV

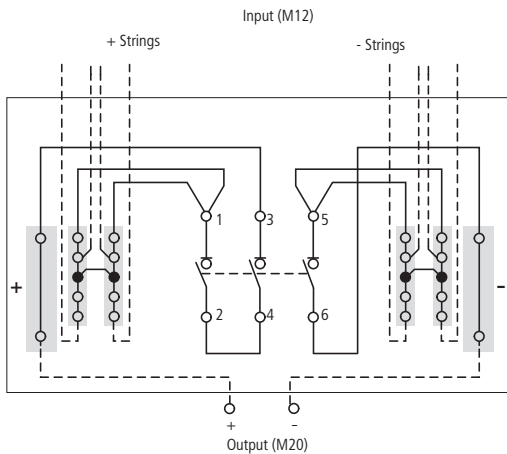

SOL60/8MC3
SOL60/8MC4

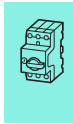
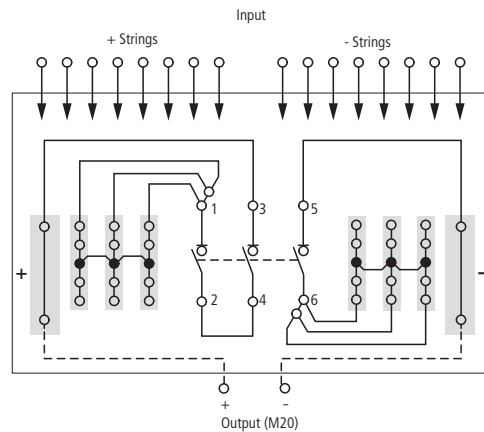

Auslösekennlinie

Auslösekennlinie
DC-Strangschutzschalter PKZ-SOL

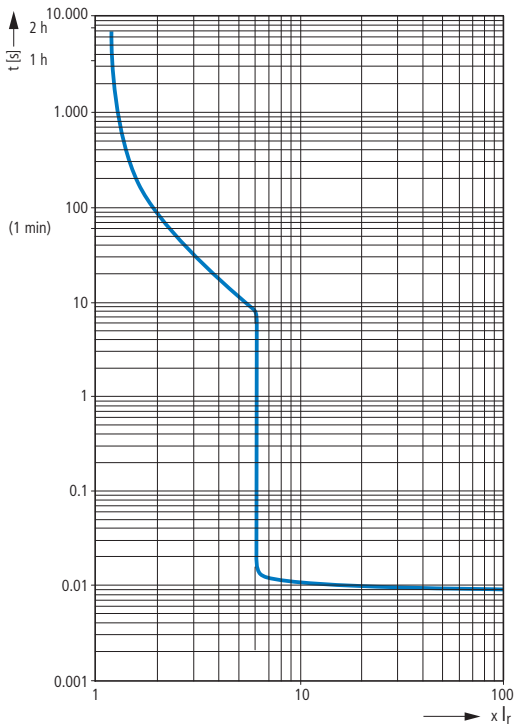

Kennlinien Einstellwert - Kurzschlussstrom

Gemäß Entwurf der IEC 62548-1 muss für den Schutz von Photovoltaikmodulen der Auslösestrom des

Schutzschalters zwischen dem 1,4 bis 2-fachen Wert des Kurzschlussstromes der Photovoltaikmodule liegen. Da auf der Einstellskala des Schutzschalters lediglich die Stromwerte des eingebauten Überlastauslösers auf-

getragen werden können¹⁾, muss der Zusammenhang zwischen Auslösestrom des Schutzgerätes und Kurzschlussstrom der Photovoltaikmodule für jeden Punkt der Skala in geeigneter Form angegeben werden.

Einstellhilfe für Strangschutzschalter PKZ-SOL

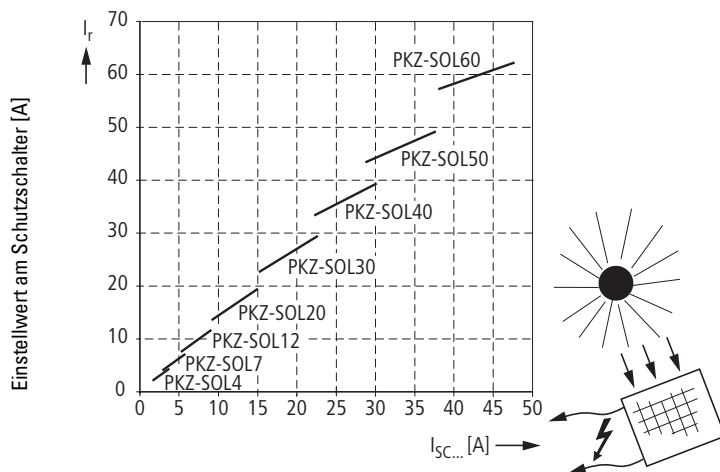

Kurzschlussstrom Solarmodul [A]

¹⁾ Eine direkte Angabe des Photovoltaik-Kurzschlussstromes auf der Einstellskala des Schutzschalters verbietet die Norm IEC/EN 60947-2 (Abschnitt 4.7.3), wonach dort nur der Stromeinstellwert des Ansprechstromes aufgetragen werden darf.

Technische Daten

			SOL20	SOL30	SOL60
Bemessungsbetriebsstrom I_e bei DC-21A	A		20	30	63
Polzahl			2	2	2
Bemessungsbetriebsspannung U_e	V DC		1000	1000	1000
Trenneigenschaften			ja	ja	ja
Normen und Bestimmungen			IEC/EN 60 947-3 UL 508, TÜV-Zertifikat		
Lebensdauer mechanisch	Schaltspiele		100.000	100.000	30.000
Lebensdauer elektrisch	Schaltspiele		100.000	100.000	30.000
Max. Schalthäufigkeit mechanisch	S/h		120	120	120
Klimafestigkeit			Feuchte Wärme, konstant, nach IEC 60 068-2-78 Feuchte Wärme, zyklisch, nach IEC 60 068-2-30		
Umgebungstemperatur	min./max.	°C	-25 ... +60	-25 ... +60	-25 ... +60
Einbaulage			beliebig	beliebig	beliebig
Schutzart	IP		65	65	65
Abmessungen					
Breite		mm	100	100	160
Höhe		mm	215	215	305
Tiefe		mm	130	130	210
Gewicht		kg	0,42	0,42	2,2
Abschließbarkeit in AUS-Stellung			ja	ja	ja
Bemessungskurzzeitstromfestigkeit 1sek. nach EN 60947-3	I_{cw}	kA	0,24	0,36	0,72
Bemessungskurzschlussleistungsfähigkeit nach EN 60947-3	I_{cm}	kA	0,32	0,32	0,6
Innenwiderstand		mΩ	8	7	4

			P-SOL20	P-SOL30	P-SOL60
Bemessungsbetriebsstrom bei DC-21A	I_e	A	20	30	63
Polzahl			2	2	2
Bemessungsbetriebsspannung	U_e	V DC	1000	1000	1000
Trenneigenschaften			ja	ja	ja
Normen und Bestimmungen			IEC/EN 60 947-3 UL 508, TÜV-Zertifikat		
Lebensdauer mechanisch	Schaltspiele		100.000	100.000	30.000
Lebensdauer elektrisch	Schaltspiele		100.000	100.000	30.000
Max. Schalthäufigkeit mechanisch	S/h		120	120	120
Klimafestigkeit			Feuchte Wärme, konstant, nach IEC 60 068-2-78 Feuchte Wärme, zyklisch, nach IEC 60 068-2-30		
Umgebungstemperatur					
offen	min./max.	°C	-25 ... +60	-25 ... +60	-25 ... +60
Einbaulage			beliebig	beliebig	beliebig
Abmessungen					
Breite		mm	58	58	55
Höhe		mm	93	93	140
Tiefe		mm	76	76	160
Befestigung					
Hutschiene			35 mm	35 mm	35 mm
Schraubbefestigung			–	–	2 x M4 x 18 30 x 130
Gewicht		kg	0,32	0,32	1,25
Anschlussklemmen					
feindrätig mit Aderendhülse		mm ²	1 x (1-6)	1 x (1-6)	1 x (1-35)
		mm ²	2 x (1-6)	2 x (1-6)	2 x (1-35)
ein- und mehrdrätig		AWG	18 - 14	18 - 14	14 - 2
Bemessungskurzzeitstromfestigkeit 1sek. nach EN 60947-3	I_{cw}	kA	0,24	0,36	0,72
Bemessungskurzschlussleistungsfähigkeit nach EN 60947-3	I_{cm}	kA	0,32	0,32	0,6
Innenwiderstand		mΩ	6	5	3

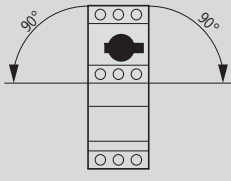
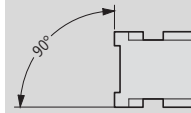

			PKZ-SOL12	PKZ-SOL20	PKZ-SOL30	PKZ-SOL40	PKZ-SOL50	PKZ-SOL60
Bemessungsbetriebsstrom bei DC-21A/750VDC	I_e	A	12	20	30	40	50	63
Polzahl			2	2	2	2	2	2
Bemessungsbetriebsspannung	U_e	V DC	900	900	900	900	900	900
Thermische Auslösung			1,05 ... 1,3 x I_e					
Elektromagnetische Auslösung			6 x I_e					
Normen und Bestimmungen			IEC/EN 60 947-2 UL 508, TÜV-Zertifikat					
Klimafestigkeit			Feuchte Wärme, konstant, nach IEC 60 068-2-78 Feuchte Wärme, zyklisch, nach IEC 60 068-2-30					
Umgebungstemperatur								
offen	min./max.	°C	-25 ... +60	-25 ... +60	-25 ... +60	-25 ... +60	-25 ... +60	-25 ... +60
Einbaulage								
			PKZ-SOL12 bis PKZ-SOL60			PKZ-SOL12 bis PKZ-SOL30		
Abmessungen								
Breite		mm	58	58	58	55	55	55
Höhe		mm	93	93	93	140	140	140
Tiefe		mm	76	76	76	160	160	160
Befestigung								
Hutschiene			35 mm	35 mm	35 mm	35 mm	35 mm	35 mm
Schraubbefestigung			–	–	–	2 x M4 x 18 30 x 130	2 x M4 x 18 30 x 130	2 x M4 x 18 30 x 130
Gewicht		kg	0,32	0,32	0,32	1,25	1,25	1,25
Anschlussklemmen								
feindrätig mit Aderendhülse		mm ²	1 x (1-6)	1 x (1-6)	1 x (1-6)	1 x (1-35)	1 x (1-35)	1 x (1-35)
		mm ²	2 x (1-6)	2 x (1-6)	2 x (1-6)	2 x (1-35)	2 x (1-35)	2 x (1-35)
ein- und mehrdrätig		AWG	18 - 14	18 - 14	18 - 14	14 - 2	14 - 2	14 - 2
Innenwiderstand		mΩ	31	12	7	–	–	–

P-SOL, PKZ-SOL, SOL

Abmessungen

P-SOL20
P-SOL30
PKZ-SOL12
PKZ-SOL20
PKZ-SOL30

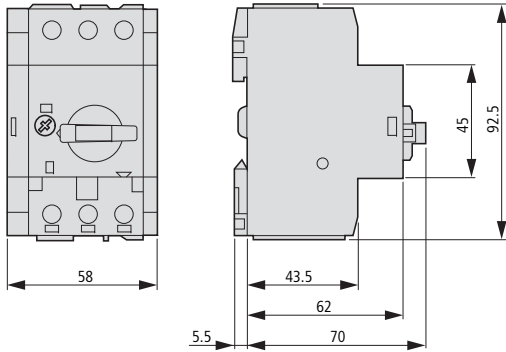

P-SOL60
PKZ-SOL40
PKZ-SOL50
PKZ-SOL60

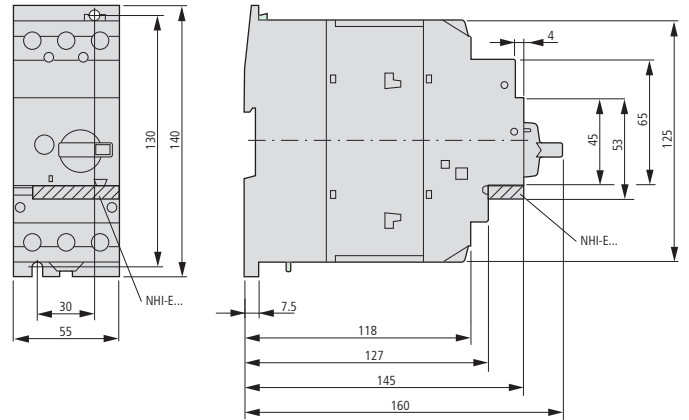

SOL20
SOL30

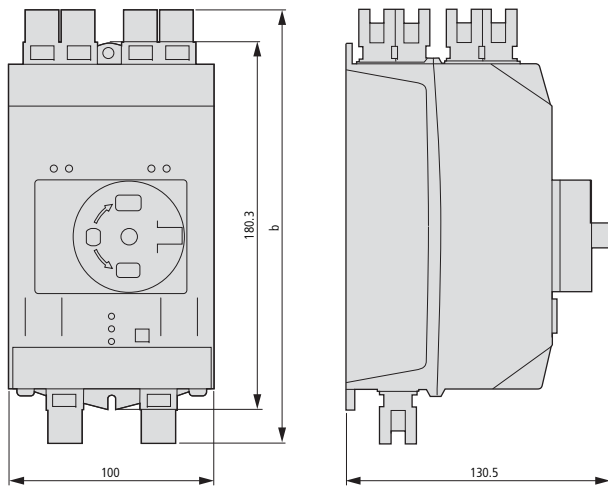

Anschluss- typ	b mm
MC3	195
MC4	234
MV	224

SOL60

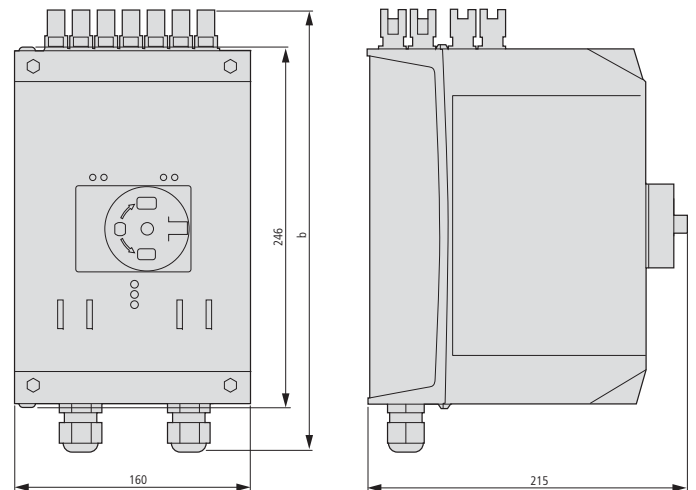

Anschluss- typ	b mm
MC3	275
MC4	314
MV	304

