



Automatización Eléctrica
Especialistas en Automatización

At the end of this document you will find links to products related to this catalog. You can go directly to our shop by clicking [HERE](#). [HERE](#)

Interface converters - FL COMSERVER UNI 232/422/485 - 2313452

Please be informed that the data shown in this PDF Document is generated from our Online Catalog. Please find the complete data in the user's documentation. Our General Terms of Use for Downloads are valid (<http://phoenixcontact.com/download>)



Second generation FL COMSERVER UNI..., serial device server for converting a serial 232/422/485 interface to Ethernet, supports TCP, UDP, Modbus gateway, and PPP applications, incl. COM port redirector software and user documentation

Why buy this product

- Modbus gateway between ModbusRTU/ASCII and ModbusTCP
- All connections can be plugged in using a COMBICON screw terminal block
- Configuration via web-based management
- Software for virtual COM ports supplied as standard



Key Commercial Data

Packing unit	1 STK
GTIN	 4 046356 451321

Technical data

Note

Utilization restriction	EMC: class A product, see manufacturer's declaration in the download area
-------------------------	---

Dimensions

Width	22.5 mm
Height	99 mm
Depth	116 mm

Ambient conditions

Ambient temperature (operation)	-25 °C ... 60 °C
	-20 °C ... 60 °C (With UL approval)
Ambient temperature (storage/transport)	-25 °C ... 70 °C
Permissible humidity (operation)	10 % ... 95 % (non-condensing)
Permissible humidity (storage/transport)	5 % ... 95 % (non-condensing)
Altitude	5000 m (For restrictions see manufacturer's declaration)

Interface converters - FL COMSERVER UNI 232/422/485 - 2313452

Technical data

Ambient conditions

Degree of protection	IP20
Noise immunity	EN 61000-6-2:2005

General

Electrical isolation	DIN EN 50178 (VCC // Ethernet // Serial)
Test voltage data interface/data interface	1.5 kV _{rms} (50 Hz, 1 min.)
Test voltage data interface/power supply	1.5 kV _{rms}
	1.5 kV _{rms} (50 Hz, 1 min.)
Standards/regulations	EN 50121-4
Electromagnetic compatibility	Conformance with EMC Directive 2004/108/EC (valid until 19.04.2016) / 2014/30/EU (valid from 20.04.2016)
Noise emission	EN 61000-6-4
Net weight	180.3 g
Housing material	PA 6.6-FR
Color	green
MTBF	666 Years (Telcordia standard, 25°C temperature, 21% operating cycle (5 days a week, 8 hours a day))
	179 Years (Telcordia standard, 40°C temperature, 34.25% operating cycle (5 days a week, 12 hours a day))
MTTF	2013 Years (SN 29500 standard, temperature 25°C, operating cycle 21 % (5 days a week, 8 hours a day))
	879 Years (SN 29500 standard, temperature 40 °C, operating cycle 34.25 % (5 days a week, 12 hours a day))
	359 Years (SN 29500 standard, temperature 40°C, operating cycle 100 % (7 days a week, 24 hours a day))
Conformance	CE-compliant
ATEX	# II 3 G Ex nA IIC T4 Gc X (Please follow the special installation instructions in the documentation!)
UL, USA	Class I, Zone 2, AEx nA IIC T5
UL, USA / Canada	508 listed
	Class I, Div. 2, Groups A, B, C, D
UL, Canada	Class I, zone 2, Ex nA IIC T5 Gc X

Power supply

Supply voltage range	19.2 V AC/DC ... 28.8 V AC/DC (via pluggable COMBICON screw terminal block)
	22.8 V DC ... 25.2 V DC (as an alternative or redundant, via backplane bus contact and system current supply)
Typical current consumption	100 mA (24 V DC)

Serial interface

Interface 1	Ethernet interface, 10/100BASE-T(X) in acc. with IEEE 802.3u
Interface	Ethernet
Connection method	RJ45 socket, shielded
Transmission length	≤ 100 m (shielded twisted pair)

Interface converters - FL COMSERVER UNI 232/422/485 - 2313452

Technical data

Serial interface

Protocols supported	TCP/IP, UDP, Modbus (TCP, RTU/ASCII), PPP
Auxiliary protocols	ARP, DHCP, BOOTP, SNMP, RIP, RARP, HTTP, TFTP
Data flow control/protocols	Modbus/TCP
Serial transmission speed	10/100 Mbps, auto negotiation
Interface 2	V.24 (RS-232) interface in acc. with ITU-T V.28, EIA/TIA-232, DIN 66259-1
Interface	RS-232
Connection method	D-SUB-9 plug
File format/coding	UART/NRZ: 7/8 Bit Data, 1/2 Bit Stopp, None/Even/Odd Parity
Transmission length	15 m
Pin assignment	DTE/DCE switchover via web-based management
Data flow control/protocols	Software handshake, Xon/Xoff, or hardware handshake RTS/CTS // 3964 R compatible, Modbus RTU/ASCII
Serial transmission speed	0.3; 0.6; 1.2; 2.4; 4.8; 7.2; 9.6; 19.2; 38.4; 57.6; 115.2; 187.5; 230.4 kbps
Interface 3	RS-422 interface in acc. with ITU-T V.11, EIA/TIA-422, DIN 66348-1
Interface	RS-422
Connection method	Plug-in/screw connection via COMBICON
File format/coding	Serial asynchronous UART/NRZ, 7/8 data, 1/2 stop, 1 parity, 10/11-bit character length
Transmission length	≤ 1200 m
Termination resistor	390 Ω (configurable)
	180 Ω
	390 Ω
Data flow control/protocols	Automatic control
Serial transmission speed	0.3; 0.6; 1.2; 2.4; 4.8; 7.2; 9.6; 19.2; 38.4; 57.6; 115.2; 187.5; 230.4; 500; 1000 kbps
Interface 4	RS-485 interface, in acc. with EIA/TIA-485, DIN 66259-4/RS-485 2-wire
Interface	RS-485
Connection method	Plug-in/screw connection via COMBICON
File format/coding	Serial asynchronous UART/NRZ, 7/8 data, 1/2 stop, 1 parity, 10/11-bit character length
Termination resistor	390 Ω
	180 Ω
	390 Ω (configurable)
Data flow control/protocols	Automatic control
Serial transmission speed	0.3; 0.6; 1.2; 2.4; 4.8; 7.2; 9.6; 19.2; 38.4; 57.6; 115.2; 187.5; 230.4; 500; 1000 kbps

Function

Management	Web-based management, SNMP, emergency exit with Telnet and serial
Status and diagnostic indicators	LEDs: UL (logic voltage), TD + RD (data activity serial), FD (full duplex), 100 (100 Mbps mode), Link (Ethernet), Activity (Ethernet), ERR (error)

Standards and Regulations

Interface converters - FL COMSERVER UNI 232/422/485 - 2313452

Technical data

Standards and Regulations

Electromagnetic compatibility	Conformance with EMC Directive 2004/108/EC (valid until 19.04.2016) / 2014/30/EU (valid from 20.04.2016)
Type of test	Free fall in acc. with IEC 60068-2-32
Test result	1 m
Type of test	Vibration resistance in acc. with EN 60068-2-6/IEC 60068-2-6
Test result	5g, 10-150 Hz, 2.5 h, in XYZ direction
Type of test	Shock in acc. with EN 60068-2-27/IEC 60068-2-27
Test result	15g, 11 ms period, half-sine shock pulse
Type of test	Shock in acc. with EN 60068-2-27/IEC 60068-2-27
Test result	30g, 11 ms period, half-sine shock pulse
Noise emission	EN 61000-6-4
Noise immunity	EN 61000-6-2:2005
Free from substances that could impair the application of coating	according to P-VW 3.10.7 57 65 0 VW-AUDI-Seat central standard
Standards/regulations	EN 50121-4
Conformance	CE-compliant
ATEX	# II 3 G Ex nA IIC T4 Gc X
UL, USA	Class I, Zone 2, AEx nA IIC T5
UL, USA / Canada	508 listed
	Class I, Div. 2, Groups A, B, C, D
UL, Canada	Class I, zone 2, Ex nA IIC T5 Gc X

Classifications

eCl@ss

eCl@ss 4.0	27250504
eCl@ss 4.1	27250504
eCl@ss 5.0	27250504
eCl@ss 5.1	27250504
eCl@ss 6.0	27250504
eCl@ss 7.0	27250504
eCl@ss 8.0	19179290

ETIM

ETIM 2.0	EC000310
ETIM 3.0	EC000310
ETIM 4.0	EC000310
ETIM 5.0	EC000310

UNSPSC

UNSPSC 6.01	30211506
UNSPSC 7.0901	39121008

Interface converters - FL COMSERVER UNI 232/422/485 - 2313452

Classifications

UNSPSC

UNSPSC 11	39121008
UNSPSC 12.01	39121008
UNSPSC 13.2	39121008

Approvals

Approvals

Approvals

UL Listed / cUL Listed / EAC / EAC / KC / cULus Listed

Ex Approvals

ATEX / UL Listed / cUL Listed / cULus Listed

Approvals submitted

Approval details

UL Listed 

cUL Listed 

EAC

EAC

KC

cULus Listed 

Drawings

Interface converters - FL COMSERVER UNI 232/422/485 - 2313452

Connection diagram

FL COMSERVER RS-485

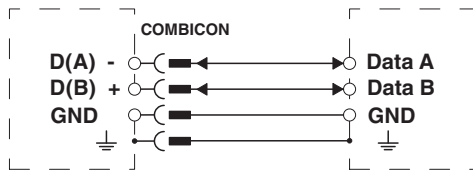

RS-485 connection

Connection diagram

FL COMSERVER RS-422

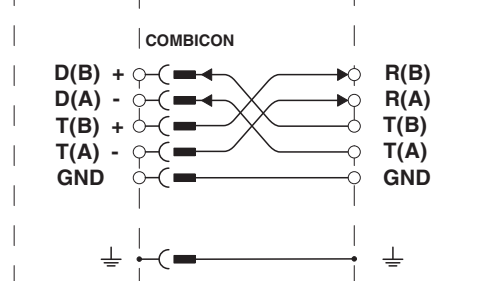

RS-422 connection

Application drawing

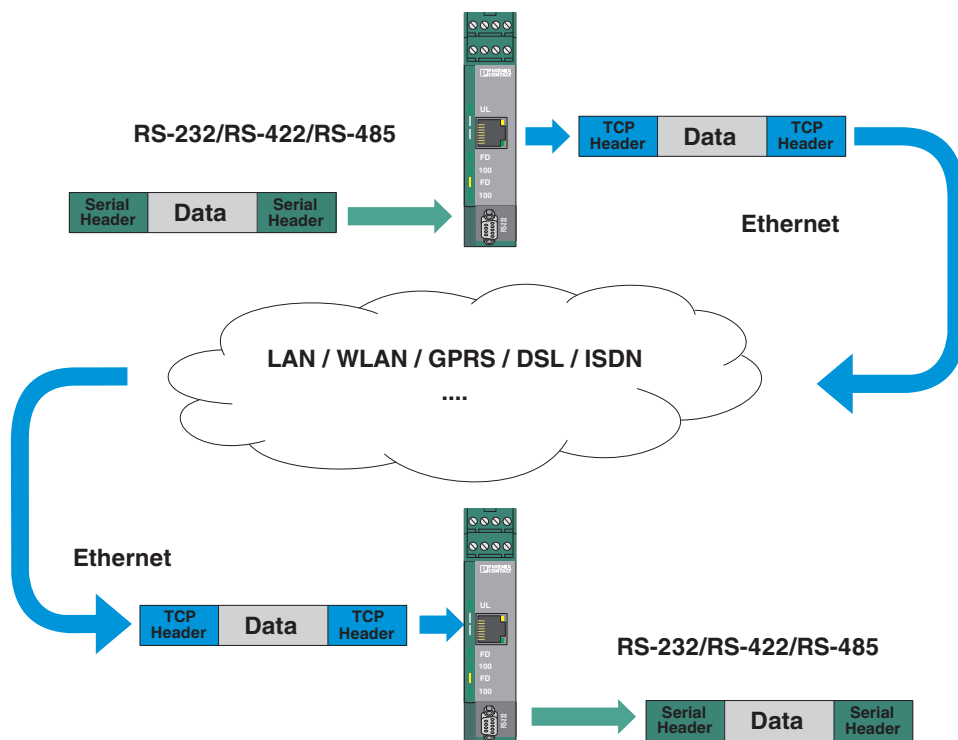

Serial data transmission via Ethernet

Interface converters - FL COMSERVER UNI 232/422/485 - 2313452

Application drawing

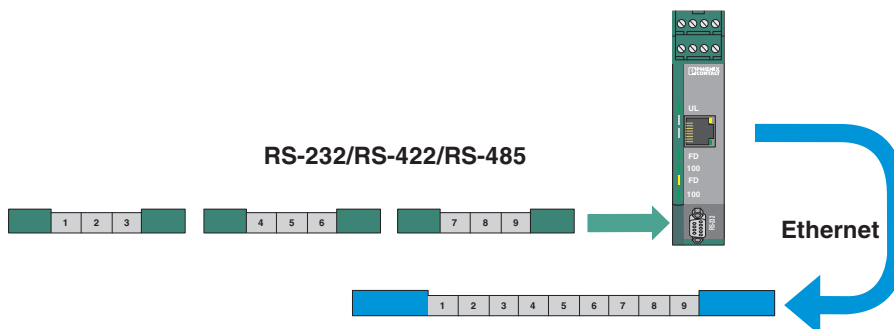

Large value: "Idle Force Timeout Characters"

Application drawing

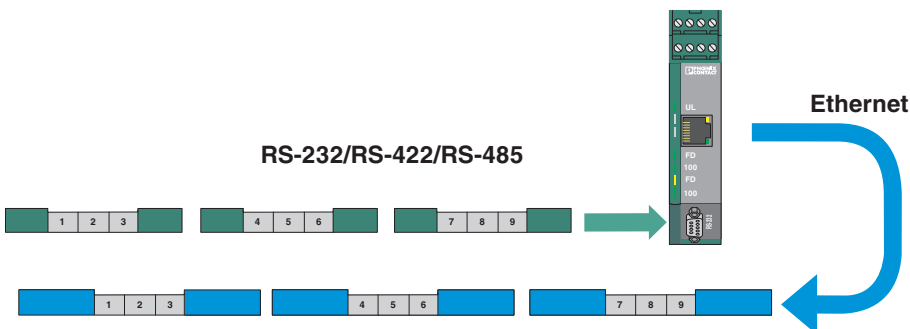

Small value: "Idle Force Timeout Characters"

Phoenix Contact 2016 © - all rights reserved
<http://www.phoenixcontact.com>

PHOENIX CONTACT GmbH & Co. KG
Flachsmarktstr. 8
32825 Blomberg
Germany
Tel. +49 5235 300
Fax +49 5235 3 41200
<http://www.phoenixcontact.com>



Below is a list of articles with direct links to our shop Electric Automation Network where you can see:

- Quote per purchase volume in real time.
- Online documentation and datasheets of all products.
- Estimated delivery time enquiry in real time.
- Logistics systems for the shipment of materials almost anywhere in the world.
- Purchasing management, order record and tracking of shipments.

To access the product, [click on the green button.](#)

Product	Code	Reference	Product link
Second generation FL COMSERVER UNI..., serial device server for converting a serial 232/422/485 interface to Ethernet, supports TCP, UDP, Modbus gateway, and PPP applications, incl. COM port redirector software and user documentation	2313452	FL COMSERVER UNI 232/422/485	Buy on EAN