



Automatización Eléctrica
Especialistas en Automatización

At the end of this document you will find links to products related to this catalog. You can go directly to our shop by clicking [HERE](#). [HERE](#)

Universal current transducer - MCR-SL-CUC-400-I - 2308072

Please be informed that the data shown in this PDF Document is generated from our Online Catalog. Please find the complete data in the user's documentation. Our General Terms of Use for Downloads are valid (<http://phoenixcontact.com/download>)



Universal current transducer, for measuring DC, AC, and distorted currents, 0 ... 400 A input current, 4 ... 20 mA output

The MCR-SL-CUC-100-I is illustrated

Why buy this product

- Variable mounting on DIN rail and mounting plate
- Simple connection technology thanks to COMBICON plug-in connection terminal blocks
- Compact dimensions also enable distributed use
- Universal current measurement, no shunt required
- 3-way isolation

Key Commercial Data

Packing unit	1 STK
GTIN	 4 046356 566568

Technical data

Dimensions

Width	90 mm
Height	33.8 mm
Depth	85 mm

Ambient conditions

Ambient temperature (operation)	-40 °C ... 65 °C
Ambient temperature (storage/transport)	-40 °C ... 85 °C
Degree of protection	IP20

Input data

Input current range	0 A ... 400 A
Overload capacity	2.5 x I _N
Frequency measuring range	20 Hz ... 6000 Hz (0 Hz)
Connection method	Cable design: 32 mm diameter

Output data

Universal current transducer - MCR-SL-CUC-400-I - 2308072

Technical data

Output data

Output name	Current output
Current output signal	4 mA ... 0.02 A
Max. output current	< 25 mA
Load/output load current output	< 300 Ω

Switching output

Output name	No switching output
-------------	---------------------

Power supply

Nominal supply voltage	24 V DC
Supply voltage range	20 V DC ... 30 V DC
Max. current consumption	(30 + I _{OUT}) mA
Power consumption	1.65 W

Connection data

Conductor cross section solid min.	0.25 mm ²
Conductor cross section solid max.	2.5 mm ²
Conductor cross section AWG min.	24
Conductor cross section AWG max.	12
Conductor cross section flexible min.	0.2 mm ²
Conductor cross section flexible max.	2.5 mm ²
Stripping length	10 mm

General

Maximum transmission error	<± 1 % (of final value)
Temperature coefficient, typical	0.02 %/K (0 ... 60°C)
	0.04 %/K (-40 ... 65°C)
Linearity error	<± 1 % (From the range end value)
Step response (10-90%)	150 ms
Overvoltage category	III
Degree of pollution	2
Rated insulation voltage	300 V AC
Test voltage input/output	3.5 kV (50 Hz, 1 min.)
Test voltage input/power supply	3.5 kV (50 Hz, 1 min.)
Noise emission	EN 61000-6-4
Noise immunity	EN 61000-6-2
Color	green
Housing material	Frianyl B63 V0 GV30
Conformance	CE-compliant
UL, USA / Canada	UL/C-UL listed UL 508

Standards and Regulations

Noise emission	EN 61000-6-4
----------------	--------------

Universal current transducer - MCR-SL-CUC-400-I - 2308072

Technical data

Standards and Regulations

Noise immunity	EN 61000-6-2
Conformance	CE-compliant
UL, USA / Canada	UL/C-UL listed UL 508

Classifications

eCl@ss

eCl@ss 4.0	27200303
eCl@ss 4.1	27200303
eCl@ss 5.0	27200303
eCl@ss 5.1	27210902
eCl@ss 6.0	27210902
eCl@ss 7.0	27210902
eCl@ss 8.0	27210902

ETIM

ETIM 3.0	EC002475
ETIM 4.0	EC002048
ETIM 5.0	EC002048

UNSPSC

UNSPSC 6.01	30211506
UNSPSC 7.0901	39121008
UNSPSC 11	39121008
UNSPSC 12.01	39121008
UNSPSC 13.2	39121008

Approvals

Approvals

Approvals

UL Listed / cUL Listed / EAC / EAC / EAC / cULus Listed

Ex Approvals

Approvals submitted

Approval details

Universal current transducer - MCR-SL-CUC-400-I - 2308072

Approvals

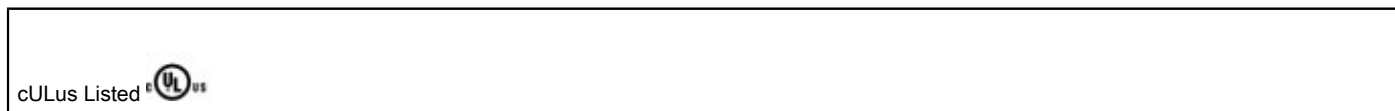
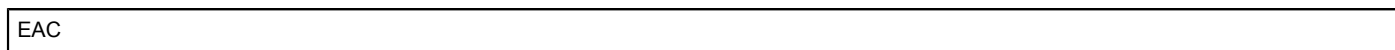
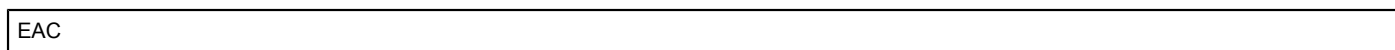
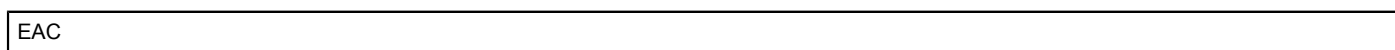

Drawings

Dimensional drawing

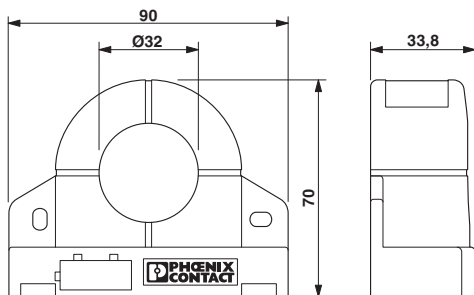

Circuit diagram

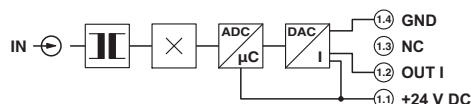

Universal current transducer - MCR-SL-CUC-400-I - 2308072

Schematic diagram

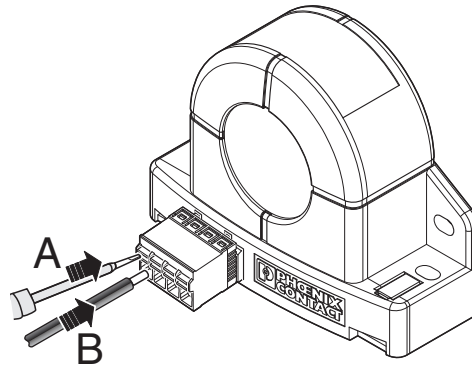

Phoenix Contact 2016 © - all rights reserved
<http://www.phoenixcontact.com>

PHOENIX CONTACT GmbH & Co. KG
Flachsmarktstr. 8
32825 Blomberg
Germany
Tel. +49 5235 300
Fax +49 5235 3 41200
<http://www.phoenixcontact.com>



Automatización Eléctrica
Especialistas en Automatización

Below is a list of articles with direct links to our shop Electric Automation Network where you can see:

- Quote per purchase volume in real time.
- Online documentation and datasheets of all products.
- Estimated delivery time enquiry in real time.
- Logistics systems for the shipment of materials almost anywhere in the world.
- Purchasing management, order record and tracking of shipments.

To access the product, [click on the green button.](#)

Product	Code	Reference	Product link
Universal current transducer, for measuring DC, AC, and distorted currents, 0 ... 400 A input current, 4 ... 20 mA output	2308072	MCR-SL-CUC-400-I	Buy on EAN