



Automatización Eléctrica
Especialistas en Automatización

At the end of this document you will find links to products related to this catalog. You can go directly to our shop by clicking [HERE](#). [HERE](#)

Base strip - GMSTBV 2,5/ 6-GF-7,62 - 1829196

Please be informed that the data shown in this PDF Document is generated from our Online Catalog. Please find the complete data in the user's documentation. Our General Terms of Use for Downloads are valid (<http://phoenixcontact.com/download>)

Header, Nominal current: 12 A, Rated voltage (III/2): 630 V, Number of positions: 6, Pitch: 7.62 mm, Color: green, Contact surface: Tin, Mounting: Wave soldering



The figure shows a 10-position version of the product

Why buy this product

- Plug-in direction vertical to the PCB
- Headers with straight solder pins for 630 V applications (III/2)



Key Commercial Data

Packing unit	50 STK
GTIN	

Technical data

Dimensions

Length	8.6 mm
Pitch	7.62 mm
Dimension a	38.1 mm
Constructional height	12 mm
Length of the solder pin	3.9 mm
Pin dimensions	1 x 1 mm
Hole diameter	1.4 mm

General

Range of articles	GMSTBV 2,5/..-GF
Insulating material group	I
Rated surge voltage (III/3)	6 kV
Rated surge voltage (III/2)	6 kV
Rated surge voltage (II/2)	6 kV

Base strip - GMSTBV 2,5/ 6-GF-7,62 - 1829196

Technical data

General

Rated voltage (III/3)	400 V
Rated voltage (III/2)	630 V
Rated voltage (II/2)	630 V
Connection in acc. with standard	EN-VDE
Nominal current I _N	12 A
Maximum load current	12 A
Insulating material	PA
Flammability rating according to UL 94	V0
Color	green
Number of positions	6

Standards and Regulations

Connection in acc. with standard	EN-VDE
	CSA
Flammability rating according to UL 94	V0

Classifications

eCl@ss

eCl@ss 4.0	272607xx
eCl@ss 4.1	27260701
eCl@ss 5.0	27260701
eCl@ss 5.1	27260701
eCl@ss 6.0	27260704
eCl@ss 7.0	27440402
eCl@ss 8.0	27440402
eCl@ss 9.0	27440402

ETIM

ETIM 3.0	EC001121
ETIM 4.0	EC002637
ETIM 5.0	EC002637

UNSPSC

UNSPSC 6.01	30211810
UNSPSC 7.0901	39121409
UNSPSC 11	39121409
UNSPSC 12.01	39121409
UNSPSC 13.2	39121409

Base strip - GMSTBV 2,5/ 6-GF-7,62 - 1829196

Approvals

Approvals

Approvals

CSA / UL Recognized / VDE Gutachten mit Fertigungsüberwachung / cUL Recognized / IECCE CB Scheme / EAC / cULus Recognized

Ex Approvals

Approvals submitted

Approval details

CSA	
Nominal current IN	10 A
Nominal voltage UN	300 V

UL Recognized		
	B	D
Nominal current IN	15 A	10 A
Nominal voltage UN	300 V	300 V

VDE Gutachten mit Fertigungsüberwachung	
Nominal current IN	12 A
Nominal voltage UN	400 V

cUL Recognized		
	B	D
Nominal current IN	15 A	10 A
Nominal voltage UN	300 V	300 V

Base strip - GMSTBV 2,5/ 6-GF-7,62 - 1829196

Approvals

IECEE CB Scheme	
Nominal current I_N	12 A
Nominal voltage U_N	400 V

EAC

cULus Recognized

Drawings

Drilling diagram

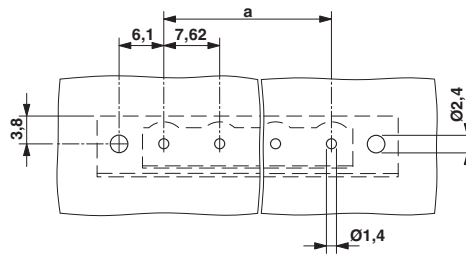

Base strip - GMSTBV 2,5/ 6-GF-7,62 - 1829196

Dimensional drawing

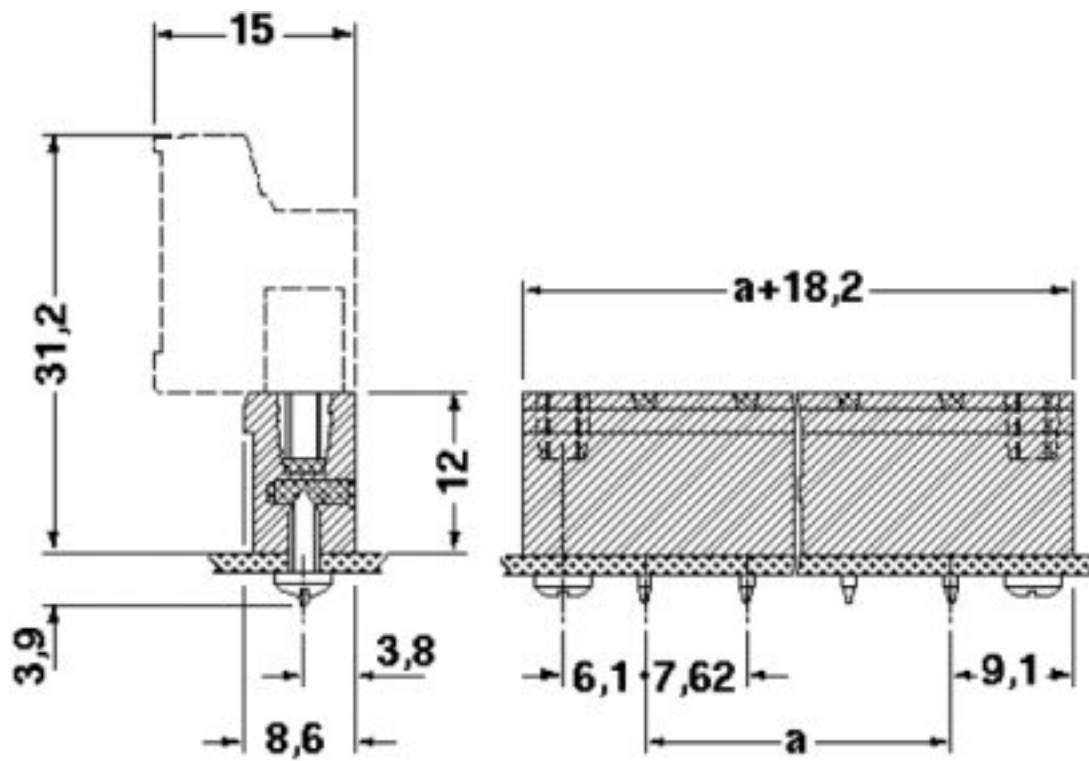

Phoenix Contact 2016 © - all rights reserved
<http://www.phoenixcontact.com>

PHOENIX CONTACT GmbH & Co. KG
Flachsmarktstr. 8
32825 Blomberg
Germany
Tel. +49 5235 300
Fax +49 5235 3 41200
<http://www.phoenixcontact.com>



Below is a list of articles with direct links to our shop Electric Automation Network where you can see:

- Quote per purchase volume in real time.
- Online documentation and datasheets of all products.
- Estimated delivery time enquiry in real time.
- Logistics systems for the shipment of materials almost anywhere in the world.
- Purchasing management, order record and tracking of shipments.

To access the product, [click on the green button.](#)

Product	Code	Reference	Product link
Header, Nominal current: 12 A, Rated voltage (III/2): 630 V, Number of positions: 6, Pitch: 7.62 mm, Color: green, Contact surface: Tin, Mounting: Soldering	1829196	GMSTBV 2,5/ 6-GF-7,62	Buy on EAN