



Automatización Eléctrica
Especialistas en Automatización

At the end of this document you will find links to products related to this catalog. You can go directly to our shop by clicking [HERE](#). [HERE](#)

Printed-circuit board connector - DMCV 1,5/ 8-G1F-3,5-LRP20THRR56 - 1818766

Please be informed that the data shown in this PDF Document is generated from our Online Catalog. Please find the complete data in the user's documentation. Our General Terms of Use for Downloads are valid (<http://phoenixcontact.com/download>)



Header, Nominal current: 8 A, Rated voltage (III/2): 160 V, Number of positions: 8, Pitch: 3.5 mm, Color: black, Contact surface: Tin, Mounting: THR soldering

The figure shows a 10-pos. version with 20 contacts



Key Commercial Data

Packing unit	220 STK
Minimum order quantity	220 STK
GTIN	 4 046356 757874

Technical data

Dimensions

Length	10.6 mm
Pitch	3.50 mm
Dimension a	24.5 mm
Constructional height	10 mm
Height	12 mm
Length of the solder pin	2 mm
Pin dimensions	0,8 x 0,8 mm
Pin spacing	5.50 mm
Hole diameter	1.4 mm

General

Range of articles	DMCV 1,5/...-G1F-THR
Insulating material group	IIIa
Rated surge voltage (III/3)	2.5 kV
Rated surge voltage (III/2)	2.5 kV

Printed-circuit board connector - DMCV 1,5/ 8-G1F-3,5-LRP20THRR56 - 1818766

Technical data

General

Rated surge voltage (II/2)	2.5 kV
Rated voltage (III/3)	160 V
Rated voltage (III/2)	160 V
Rated voltage (II/2)	250 V
Connection in acc. with standard	EN-VDE
Nominal current I _N	8 A
Maximum load current	8 A
Insulating material	LCP
Flammability rating according to UL 94	V0
Color	black
Number of positions	8

Standards and Regulations

Connection in acc. with standard	EN-VDE
	CUL
Flammability rating according to UL 94	V0

Classifications

eCl@ss

eCl@ss 4.0	272607xx
eCl@ss 4.1	27260701
eCl@ss 5.0	27260701
eCl@ss 5.1	27260701
eCl@ss 6.0	27260704
eCl@ss 7.0	27440402
eCl@ss 8.0	27440402
eCl@ss 9.0	27440402

ETIM

ETIM 3.0	EC001121
ETIM 4.0	EC002637
ETIM 5.0	EC002637

UNSPSC

UNSPSC 6.01	30211810
UNSPSC 7.0901	39121409
UNSPSC 11	39121409
UNSPSC 12.01	39121409
UNSPSC 13.2	39121409

Printed-circuit board connector - DMCV 1,5/ 8-G1F-3,5-LRP20THRR56 - 1818766

Approvals

Approvals

Approvals

VDE Gutachten mit Fertigungsüberwachung / IECCE CB Scheme / cULus Recognized

Ex Approvals

Approvals submitted

Approval details

VDE Gutachten mit Fertigungsüberwachung 	
Nominal current I _N	8 A
Nominal voltage U _N	160 V

IECEE CB Scheme 	
Nominal current I _N	8 A
Nominal voltage U _N	160 V

cULus Recognized		
	B	C
Nominal current I _N	8 A	8 A
Nominal voltage U _N	150 V	50 V

Drawings

Printed-circuit board connector - DMCV 1,5/ 8-G1F-3,5-LRP20THRR56 - 1818766

Schematic diagram

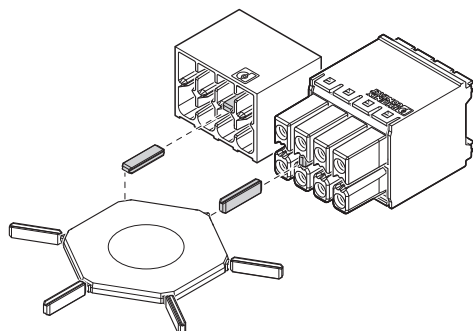

Use of the CP-DMC... coding profile

Drilling diagram

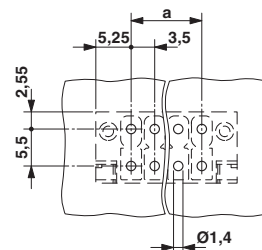

Dimensional drawing

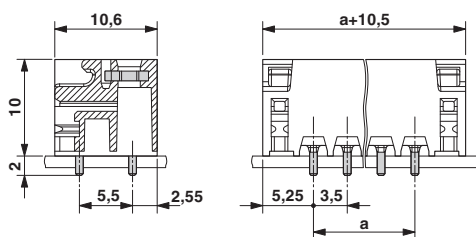

Schematic diagram

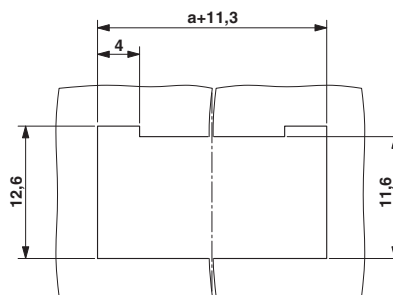

Panel cutout

Phoenix Contact 2016 © - all rights reserved
<http://www.phoenixcontact.com>

PHOENIX CONTACT GmbH & Co. KG
Flachsmarktstr. 8
32825 Blomberg
Germany
Tel. +49 5235 300
Fax +49 5235 3 41200
<http://www.phoenixcontact.com>

Below is a list of articles with direct links to our shop Electric Automation Network where you can see:

- Quote per purchase volume in real time.
- Online documentation and datasheets of all products.
- Estimated delivery time enquiry in real time.
- Logistics systems for the shipment of materials almost anywhere in the world.
- Purchasing management, order record and tracking of shipments.

To access the product, [click on the green button.](#)

Product	Code	Reference	Product link
Header, Nominal current: 8 A, Rated voltage (III/2): 160 V, Number of positions: 8, Pitch: 3.5 mm, Color: black, Contact surface: Tin, Mounting: Taped SMD/THT/THR components	1818766	DMCV 1,5/ 8-G1F-3,5-LRP20THRR5	Buy on EAN