



**Automatización Eléctrica**  
Especialistas en Automatización

At the end of this document you will find links to products related to this catalog. You can go directly to our shop by clicking [HERE](#). [HERE](#)

## Panel feed-through - SACC-DSI-FS-4CON-L180 SCO - 1553462

Please be informed that the data shown in this PDF Document is generated from our Online Catalog. Please find the complete data in the user's documentation. Our General Terms of Use for Downloads are valid (<http://phoenixcontact.com/download>)



Sensor/actuator flush-type socket, 4-pos., M12 SPEEDCON, A-coded, rear/screw mounting with Pg9 thread, with straight solder connection



### Key Commercial Data

Packing unit	20 STK
GTIN	 4 046356 156875

### Technical data

#### Dimensions

Length of the solder pin	6 mm
--------------------------	------

#### Ambient conditions

Ambient temperature (operation)	-25 °C ... 85 °C (Plug / socket)
	-40 °C ... 85 °C (without mechanical actuation)
Degree of protection	IP67

#### General

Note	The electrical and mechanical data specified assume that the connector pair is correctly locked and mounted. If the connector is unlocked and if there is a danger of contamination, the connector must be sealed using a protective cap > IP54. Influences arising from litz wires, cables or PCB assembly must also be taken into consideration.
Rated current at 40°C	4 A
Rated voltage	250 V
Rated surge voltage	2.5 kV
Number of positions	4
Insulation resistance	≥ 100 MΩ
Coding	A - standard
Standards/regulations	M12 connector IEC 61076-2-101
Status display	No

# Panel feed-through - SACC-DSI-FS-4CON-L180 SCO - 1553462

## Technical data

### General

Overvoltage category	II
Degree of pollution	3
Connection method	Solder pins
Insertion/withdrawal cycles	> 100
Torque	3 Nm ... 4 Nm
Mounting type	Rear mounting Pg9 With flat nut

### Material

Flammability rating according to UL 94	V0
Contact material	CuZn
Contact surface material	Au
Contact carrier material	PA 66
Material, knurls	Zinc die-cast, nickel-plated
Sealing material	NBR

### Cable

Ambient temperature (operation)	-40 °C ... 85 °C (cable, fixed installation)
	-25 °C ... 85 °C (cable, flexible installation)

### Standards and Regulations

Standard designation	M12 connector
Standards/regulations	IEC 61076-2-101
Flammability rating according to UL 94	V0

## Classifications

### eCl@ss

eCl@ss 4.0	27250313
eCl@ss 4.1	27250313
eCl@ss 5.0	27143423
eCl@ss 5.1	27143423
eCl@ss 6.0	27143423
eCl@ss 7.0	27449001
eCl@ss 8.0	27440103

### ETIM

ETIM 3.0	EC002061
ETIM 4.0	EC002062
ETIM 5.0	EC002061

### UNSPSC

UNSPSC 6.01	31251501
UNSPSC 7.0901	31251501

# Panel feed-through - SACC-DSI-FS-4CON-L180 SCO - 1553462

## Classifications

### UNSPSC

UNSPSC 11	31251501
UNSPSC 12.01	31251501
UNSPSC 13.2	31251501

## Approvals

### Approvals

#### Approvals

UL Recognized / EAC / cULus Recognized

#### Ex Approvals

#### Approvals submitted

## Approval details

UL Recognized 	
mm <sup>2</sup> /AWG/kcmil	26-20
Nominal current I <sub>N</sub>	4 A
Nominal voltage U <sub>N</sub>	250 V

EAC
-----

cULus Recognized	
mm <sup>2</sup> /AWG/kcmil	20
Nominal current I <sub>N</sub>	4 A
Nominal voltage U <sub>N</sub>	250 V

## Drawings

# Panel feed-through - SACC-DSI-FS-4CON-L180 SCO - 1553462

Dimensional drawing

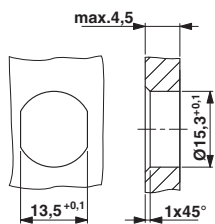

Schematic diagram

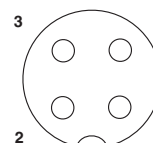

Pin assignment M12 socket, 4-pos., A-coded, view female side

Housing cutout for Pg9 fastening thread, mounting panel with feed-through hole (alternatively with area as anti-rotation protection for panel thicknesses > 2 mm up to max. 4.5 mm)

Drilling diagram

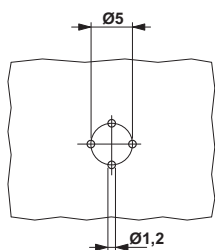

Dimensional drawing

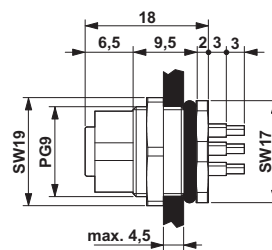

M12 flush-type connector

Dimensional drawing

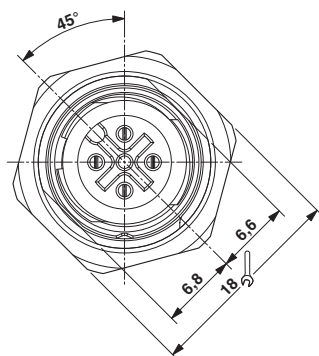

M12 front view



**Automatización Eléctrica**  
Especialistas en Automatización

Below is a list of articles with direct links to our shop Electric Automation Network where you can see:

- Quote per purchase volume in real time.
- Online documentation and datasheets of all products.
- Estimated delivery time enquiry in real time.
- Logistics systems for the shipment of materials almost anywhere in the world.
- Purchasing management, order record and tracking of shipments.

To access the product, [click on the green button.](#)

Product	Code	Reference	Product link
Sensor/actuator flush-type socket, 4-pos., M12 SPEEDCON, A-coded, rear/screw mounting with Pg9 thread, with straight solder connection	1553462	SACC-DSI-FS-4CON-L180 SCO	<a href="#">Buy on EAN</a>