



Automatización Eléctrica
Especialistas en Automatización

At the end of this document you will find links to products related to this catalog. You can go directly to our shop by clicking [HERE](#). [HERE](#)

Sensor/actuator box - SACB-6/12- 5,0PUR SCO P - 1452482

Please be informed that the data shown in this PDF Document is generated from our Online Catalog. Please find the complete data in the user's documentation. Our General Terms of Use for Downloads are valid (<http://phoenixcontact.com/download>)



Sensor/actuator box, Application: Standard, Connection method: M12-SPEEDCON-socket Plastic, Number of slots: 6, Number of positions: 5, Coding: A - standard, Slot assignment: Double, Status indication: No, Universal; Master cable connection: Fixed connection 180°, PUR/PVC, Cable length: 5 m, Shielding: No

Figure shows version with diagnostic and status indicator

Why buy this product

- Safety in the field, thanks to molded housing and high degree of protection
- Flexible, distributed bundling of signals in one master cable
- Save space: distributor box with double occupancy for two sensors in one slot
- Save time, thanks to installation with SPEEDCON fast locking system



Key Commercial Data

Packing unit	1 STK
GTIN	 4 046356 553841

Technical data

General

Rated voltage	120 V
Current carrying capacity per I/O signal	2 A
Current carrying capacity per slot	4 A
Total rated current	12 A
Number of positions	5
Number of slots	6
Sensor/actuator connection system	M12-SPEEDCON-socket

Ambient conditions

Degree of protection	IP65
	IP67
Ambient temperature (operation)	-25 °C ... 80 °C
	-40 °C ... 90 °C (for fixed installation)

Sensor/actuator box - SACB-6/12- 5,0PUR SCO P - 1452482

Technical data

Ambient conditions

	-5 °C ... 80 °C (for flexible installation)
--	---

Master cable connection data

Connection method	Fixed connection
Length of cable	5 m
Tightening torque slot sensor/actuator cable	0.4 Nm
Tightening torque of mounting screw for fixing the housing	0.5 Nm

Insulation material

Housing material	PBT
Material of the moulding mass	PUR
Contact material	Cu alloy
Contact surface material	Gold-plated
Contact carrier material	PA
Material of threaded sleeve	PBT
O-ring material	NBR

Pin assignment

Slot/position = Wire color or connection	1 / 4 (A) = WH
	1 / 2 (B) = GY/PK
	2 / 4 (A) = GN
	2 / 2 (B) = RD/BU
	3 / 4 (A) = YE
	3 / 2 (B) = WH/GN
	4 / 4 (A) = GY
	4 / 2 (B) = BN/GN
	5 / 4 (A) = PK
	5 / 2 (B) = WH/YE
	6 / 4 (A) = RD
	6 / 2 (B) = YE/BN
	1-6 / 1 (+ 120 V) = BN
	1-6 / 3 (0 V) = BU
	1-6 / 5 (PE) = GN/YE

Standards and Regulations

Standard designation	M12 connector
Standards/regulations	IEC 61076-2-101
Connection in acc. with standard	CUL

Cable

Cable type	PUR/PVC black
Cable type (abbreviation)	PUR
Cable abbreviation	LiYY11Y-HF

Sensor/actuator box - SACB-6/12- 5,0PUR SCO P - 1452482

Technical data

Cable

UL AWM style	20549
Conductor cross section	12x 0.5 mm ² (Signal line)
	3x 1 mm ² (power line)
AWG signal line	20
AWG power supply	17
Conductor structure signal line	28x 0.15 mm
Conductor structure, voltage supply	56x 0.15 mm
Core diameter including insulation	1.5 mm ±0.1 mm (Signal line)
	2.1 mm ±0.1 mm (power line)
Thickness, insulation	≥ 0.15 mm (Inner sheath)
	≥ 0.76 mm (Outer cable sheath)
Overall twist	Wires twisted in layers
External sheath, color	black RAL 9005
External cable diameter D	9.4 mm ±0.2 mm
Minimum bending radius, fixed installation	7.5 x D
Minimum bending radius, flexible installation	10 x D
Number of bending cycles	1500000
Bending radius	94 mm
Traversing path	2 m
Traversing rate	2 m/s
Cable weight	150.9 kg/km
Outer sheath, material	PUR
Material, inner sheath	PVC
Material conductor insulation	PVC
Conductor material	Bare Cu litz wires
Nominal voltage, cable	300 V
Test voltage, cable	2000 V
Special properties	Silicone-free
Flame resistance	DIN EN 50265
Resistance to oil	As per VDE 0472 Part 803
Other resistance	Highly resistant to acids, alkaline solutions and solvents
Ambient temperature (operation)	-40 °C ... 90 °C (cable, fixed installation)
	-5 °C ... 80 °C (cable, flexible installation)

Classifications

eCl@ss

eCl@ss 4.0	27140815
eCl@ss 4.1	27140815
eCl@ss 5.0	27143423

Sensor/actuator box - SACB-6/12- 5,0PUR SCO P - 1452482

Classifications

eCl@ss

eCl@ss 5.1	27143423
eCl@ss 6.0	27143423
eCl@ss 7.0	27449001
eCl@ss 8.0	27279219

ETIM

ETIM 4.0	EC002585
ETIM 5.0	EC002585

UNSPSC

UNSPSC 6.01	31261501
UNSPSC 7.0901	31261501
UNSPSC 11	31261501
UNSPSC 12.01	31261501
UNSPSC 13.2	31261501

Approvals

Approvals

Approvals

UL Recognized / cUL Recognized / EAC / cULus Recognized

Ex Approvals

Approvals submitted

Approval details

UL Recognized 	
Nominal voltage UN	120 V

cUL Recognized 	
Nominal voltage UN	120 V

Sensor/actuator box - SACB-6/12- 5,0PUR SCO P - 1452482

Approvals

EAC

cULus Recognized

Drawings

Schematic diagram

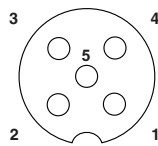

M12 slot, socket, 5-pos.

Cable cross section

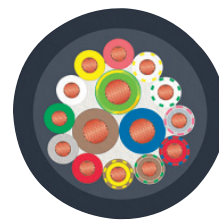

PUR/PVC black [PUR]

Circuit diagram

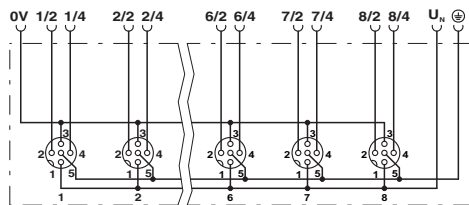

Dimensional drawing

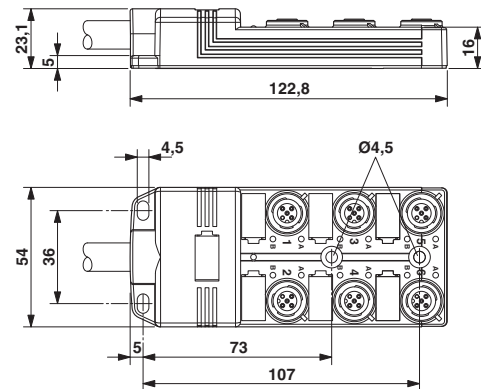



Below is a list of articles with direct links to our shop Electric Automation Network where you can see:

- Quote per purchase volume in real time.
- Online documentation and datasheets of all products.
- Estimated delivery time enquiry in real time.
- Logistics systems for the shipment of materials almost anywhere in the world.
- Purchasing management, order record and tracking of shipments.

To access the product, [click on the green button.](#)

Product	Code	Reference	Product link
Sensor/actuator box, Application: Standard, Connection method: M12-SPEEDCON-socket Plastic, Number of slots: 6, Number of positions: 5, Coding: A - standard, Slot assignment: Double, Status indication: No, Universal; Master cable connection: Fixed connection 180°, PUR/PVC, Cable length: 5 m, Shielding: No	1452482	SACB-6/12-5,0PUR SCOP	Buy on EAN