



Automatización Eléctrica
Especialistas en Automatización

At the end of this document you will find links to products related to this catalog. You can go directly to our shop by clicking [HERE](#). [HERE](#)

Flush-type connector - SACC-DSIV-MS-8CON-L90 SH SCO - 1437012

Please be informed that the data shown in this PDF Document is generated from our Online Catalog. Please find the complete data in the user's documentation. Our General Terms of Use for Downloads are valid (<http://phoenixcontact.com/download>)



Sensor/actuator flush-type connector, connector, 8-pos., M12 SPEEDCON, A-coded, shielded, rear/screw mounting with M12 thread, with polarity protection, with angled solder connection



Key Commercial Data

Packing unit	10 STK
GTIN	 4 046356 438582

Technical data

Ambient conditions

Ambient temperature (operation)	-25 °C ... 85 °C (Plug / socket)
Degree of protection	IP67

General

Rated current at 40°C	2 A
Rated voltage	30 V
Number of positions	8
Insulation resistance	≥ 100 MΩ
Coding	A - standard
Status display	No
Overvoltage category	II
Degree of pollution	3
Connection method	Solder pins
Mounting type	Rear mounting M12 x 1

Material

Flammability rating according to UL 94	V0
Contact material	CuZn
Contact surface material	Au
Contact carrier material	PA 66

Flush-type connector - SACC-DSIV-MS-8CON-L90 SH SCO - 1437012

Technical data

Material

Material, knurled	Zinc die-cast, nickel-plated
Sealing material	NBR

Standards and Regulations

Flammability rating according to UL 94	V0
--	----

Classifications

eCl@ss

eCl@ss 4.0	27250313
eCl@ss 4.1	27250313
eCl@ss 5.0	27143423
eCl@ss 5.1	27143423
eCl@ss 6.0	27143423
eCl@ss 7.0	27449001
eCl@ss 8.0	27440103

ETIM

ETIM 3.0	EC002061
ETIM 4.0	EC002061
ETIM 5.0	EC002061

UNSPSC

UNSPSC 6.01	31251501
UNSPSC 7.0901	31251501
UNSPSC 11	31251501
UNSPSC 12.01	31251501
UNSPSC 13.2	31251501

Approvals

Approvals

Approvals

UL Recognized

Ex Approvals

Approvals submitted

Flush-type connector - SACC-DSIV-MS-8CON-L90 SH SCO - 1437012

Approvals

Approval details

UL Recognized	
mm ² /AWG/kcmil	26-20
Nominal current I _N	2 A
Nominal voltage U _N	30 V

Drawings

Schematic diagram

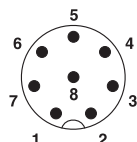

Pin assignment M12 plug, 8-pos., A-coded, view plug side

Drilling diagram

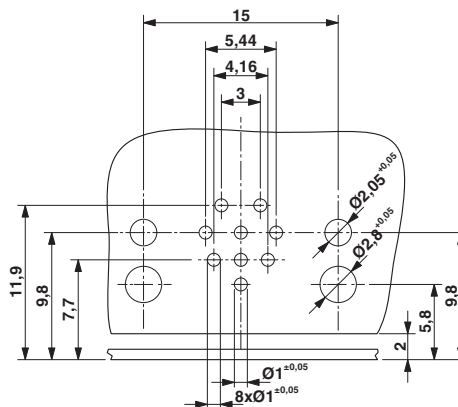

Drilling diagram

Dimensional drawing

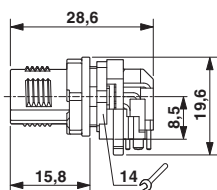

M12 flush-type connector, connector, side view

Dimensional drawing

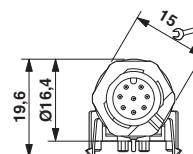

M12 flush-type connector, connector, front view

Flush-type connector - SACC-DSIV-MS-8CON-L90 SH SCO - 1437012

Dimensional drawing

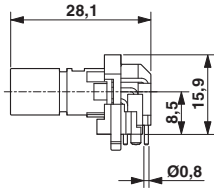

M12 flush-type connector, plug, contact carrier, side view

Dimensional drawing

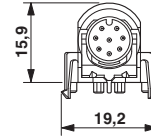

M12 flush-type connector, plug, contact carrier, front view

Dimensional drawing

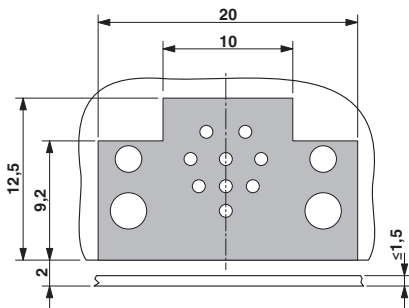

Locked area on the PCB

Dimensional drawing

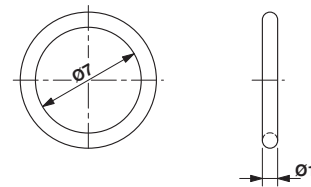

Optionally with O-ring (green) for tight seal when plugged in.
- the axial mating force of 80 N per connector may not be exceeded when using with assembled O-ring!
- Avoid radial forces!

Dimensional drawing

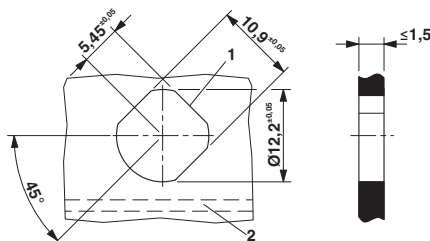

Panel cutout, view from front in case of horizontal PCB (2). The 3rd flat area is optional (1).



Below is a list of articles with direct links to our shop Electric Automation Network where you can see:

- Quote per purchase volume in real time.
- Online documentation and datasheets of all products.
- Estimated delivery time enquiry in real time.
- Logistics systems for the shipment of materials almost anywhere in the world.
- Purchasing management, order record and tracking of shipments.

To access the product, [click on the green button.](#)

Product	Code	Reference	Product link
Sensor/actuator flush-type connector, connector, 8-pos., M12 SPEEDCON, A-coded, shielded, rear/screw mounting with M12 thread, with polarity protection, with angled solder connection	1437012	SACC-DSIV-MS-8CON-L90 SH SCO	Buy on EAN