



Automatización Eléctrica
Especialistas en Automatización

At the end of this document you will find links to products related to this catalog. You can go directly to our shop by clicking [HERE](#). [HERE](#)

Flush-type connector - SACC-CI-M12MS-8CON-L90 SCO - 1436987

Please be informed that the data shown in this PDF Document is generated from our Online Catalog. Please find the complete data in the user's documentation. Our General Terms of Use for Downloads are valid (<http://phoenixcontact.com/download>)



Sensor/actuator flush-type connector, plug, 8-pos., A-coded, with angled solder connection, only contact insert

Why buy this product

- Reduzierte Montagekosten dank zweiteiliger Gerätesteckverbinder
- Alle gängigen Polbilder und Kodierungen verfügbar
- Einfache Geräteintegration durch mechanische Port-Verschraubungen mit Gewindefestigung, Einpresskontur oder zur direkten Integration in die Frontplatte
- Zusätzliche Abdichtung zum Gerät im ungesteckten Zustand



Key Commercial Data

Packing unit	20 STK
Minimum order quantity	20 STK
GTIN	 4 046356 438551

Technical data

Ambient conditions

Ambient temperature (operation)	-25 °C ... 85 °C (Plug / socket)
	-40 °C ... 85 °C (without mechanical actuation)
Degree of protection	IP67

General

Note	The electrical and mechanical data specified assume that the connector pair is correctly locked and mounted. If the connector is unlocked and if there is a danger of contamination, the connector must be sealed using a protective cap > IP54. Influences arising from litz wires, cables or PCB assembly must also be taken into consideration.
Rated current at 40°C	2 A
Rated voltage	30 V
Rated surge voltage	0.8 kV
Number of positions	8

Flush-type connector - SACC-CI-M12MS-8CON-L90 SCO - 1436987

Technical data

General

Insulation resistance	≥ 100 MΩ
Coding	A - standard
Standards/regulations	M12 connector IEC 61076-2-101
Status display	No
Overvoltage category	II
Degree of pollution	3
Connection method	Solder pins
Insertion/withdrawal cycles	> 100
Torque	3 Nm ... 4 Nm (Installation-side)
Mounting type	PCB mounting

Material

Flammability rating according to UL 94	V0
Contact material	CuZn
Contact surface material	Au
Contact carrier material	PA 66
Sealing material	FKM / EPDM

Cable

Conductor cross section	0.25 mm ²
Conductor structure signal line	14x 0.15 mm
Core diameter including insulation	1.15 mm ±0.07 mm
Thickness, insulation	0.21 mm
Insulation resistance	≥ 20 MΩ*km
Conductor resistance	≤ 57.6 mΩ/m
Nominal voltage, cable	300 V
Test voltage, cable	2000 V AC
Ambient temperature (operation)	-40 °C ... 85 °C (cable, fixed installation)
	-25 °C ... 85 °C (cable, flexible installation)

Standards and Regulations

Standard designation	M12 connector
Standards/regulations	IEC 61076-2-101
Flammability rating according to UL 94	V0

Classifications

eCl@ss

eCl@ss 4.0	27060306
eCl@ss 4.1	27060306
eCl@ss 5.0	27061801
eCl@ss 5.1	27260701

Flush-type connector - SACC-CI-M12MS-8CON-L90 SCO - 1436987

Classifications

eCl@ss

eCl@ss 6.0	27279220
eCl@ss 7.0	27440103
eCl@ss 8.0	27440103

ETIM

ETIM 3.0	EC002061
ETIM 4.0	EC002061
ETIM 5.0	EC002061

UNSPSC

UNSPSC 6.01	31251501
UNSPSC 7.0901	31251501
UNSPSC 11	31251501
UNSPSC 12.01	31251501
UNSPSC 13.2	31251501

Approvals

Approvals

Approvals

UL Recognized / EAC

Ex Approvals

Approvals submitted

Approval details

UL Recognized	
mm ² /AWG/kcmil	26-20
Nominal current I _N	2 A
Nominal voltage U _N	30 V

EAC

Drawings

Flush-type connector - SACC-CI-M12MS-8CON-L90 SCO - 1436987

Schematic diagram

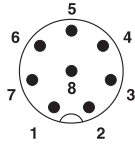

Pin assignment M12 plug, 8-pos., A-coded, view plug side

Drilling diagram

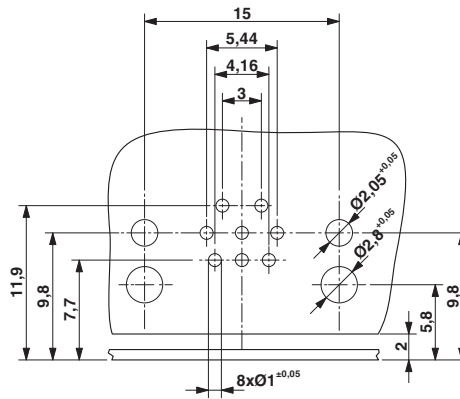

Drilling diagram only valid in connection with the SACC-M12-SCO PLUG L90 housing (order no. 1436709)

Dimensional drawing

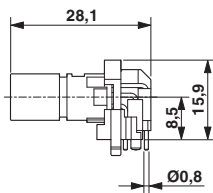

M12 flush-type connector, plug, contact carrier, side view

Dimensional drawing

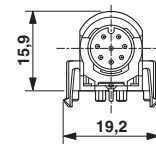

M12 flush-type connector, plug, contact carrier, front view

Dimensional drawing

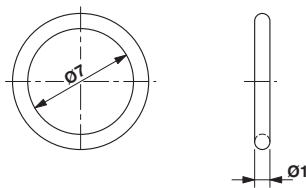

Optionally with O-ring (green) for tight seal when plugged in.
 - the axial mating force of 80 N per connector may not be exceeded when using with assembled O-ring!
 - Avoid radial forces!

Dimensional drawing

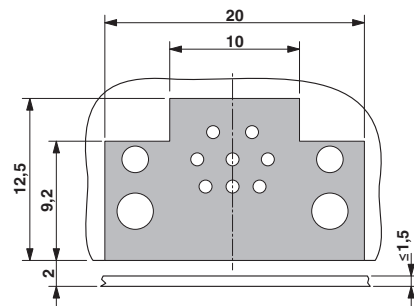

Locked area on the PCB

Phoenix Contact 2016 © - all rights reserved
<http://www.phoenixcontact.com>

PHOENIX CONTACT GmbH & Co. KG
Flachmarktstr. 8
32825 Blomberg
Germany
Tel. +49 5235 300
Fax +49 5235 3 41200
<http://www.phoenixcontact.com>



Below is a list of articles with direct links to our shop Electric Automation Network where you can see:

- Quote per purchase volume in real time.
- Online documentation and datasheets of all products.
- Estimated delivery time enquiry in real time.
- Logistics systems for the shipment of materials almost anywhere in the world.
- Purchasing management, order record and tracking of shipments.

To access the product, [click on the green button.](#)

Product	Code	Reference	Product link
Sensor/actuator flush-type connector, plug, 8-pos., A-coded, with angled solder connection, only contact insert	1436987	SACC-CI-M12MS-8CON-L90 SCO	Buy on EAN