



Automatización Eléctrica
Especialistas en Automatización

At the end of this document you will find links to products related to this catalog. You can go directly to our shop by clicking HERE. [HERE](#)

Bus system connector - SACC-M12MRB-5CON-PG 9-SH - 1430417

Please be informed that the data shown in this PDF Document is generated from our Online Catalog. Please find the complete data in the user's documentation. Our General Terms of Use for Downloads are valid (<http://phoenixcontact.com/download>)

Bus system connector, PROFIBUS, 5-position, shielded, Plug angled M12, B-coded, Screw connection, Knurl material: Zinc die-cast, nickel-plated, Cable gland Pg9, External cable diameter 6 mm ... 8 mm



Why buy this product

- Safe use in the field, thanks to a high degree of protection
- Flexible: connectors for on-site assembly
- Screw connection: proven connection technology for a large selection of different conductors
- Reliable signal transmission - 360° shielding in environments with electromagnetic interference



Key Commercial Data

Packing unit	1 STK
GTIN	 4 046356 321495

Technical data

Dimensions

External diameter	6 mm ... 8 mm
Stripping length of the sheath	40 mm
Stripping length of the individual wire	5 mm

Ambient conditions

Ambient temperature (operation)	-40 °C ... 85 °C (Plug / socket)
Degree of protection	IP67

General

Rated current at 40°C	4 A
Rated voltage	60 V DC 48 V AC
Number of positions	5
Insulation resistance	≥ 100 MΩ
Coding	B - inverse
Standards/regulations	M12 connector IEC 61076-2-101

Bus system connector - SACC-M12MRB-5CON-PG 9-SH - 1430417

Technical data

General

Signal type/category	PROFIBUS
Status display	No
Overvoltage category	II
Degree of pollution	3
Connection method	Screw connection
Conductor cross section	0.25 mm ² ... 0.75 mm ²
Conductor cross section AWG	24 ... 18
Insertion/withdrawal cycles	≥ 100
Torque	0.4 Nm (M12 knurl) 0.2 Nm (Screw terminal blocks) 0.8 Nm ... 1 Nm (Pressure nut with coupling sleeve)
Tightening torque	Screw plug insert with sleeve housing as far it will go
Assembly instructions	The wires can be connected both with ferrules and without ferrules

Material

Flammability rating according to UL 94	HB
Contact material	CuZn
Contact surface material	Au
Contact carrier material	PA
Material of grip body	Zinc die-cast, nickel-plated
Material, knurls	Zinc die-cast, nickel-plated
Sealing material	NBR

Standards and Regulations

Standard designation	M12 connector
Standards/regulations	IEC 61076-2-101
Connection in acc. with standard	CUL
Flammability rating according to UL 94	HB

Classifications

eCl@ss

eCl@ss 4.0	27250313
eCl@ss 4.1	27250313
eCl@ss 5.0	27143423
eCl@ss 5.1	27143423
eCl@ss 6.0	27143423
eCl@ss 7.0	27449001
eCl@ss 8.0	27440104
eCl@ss 9.0	27440102

Bus system connector - SACC-M12MRB-5CON-PG 9-SH - 1430417

Classifications

ETIM

ETIM 3.0	EC002062
ETIM 4.0	EC002062
ETIM 5.0	EC002062

UNSPSC

UNSPSC 6.01	31251501
UNSPSC 7.0901	31251501
UNSPSC 11	31251501
UNSPSC 12.01	31251501
UNSPSC 13.2	31251501

Approvals

Approvals

Approvals

UL Recognized / cUL Recognized / EAC / EAC / cULus Recognized

Ex Approvals

Approvals submitted

Approval details

UL Recognized

cUL Recognized

EAC

EAC

cULus Recognized

Bus system connector - SACC-M12MRB-5CON-PG 9-SH - 1430417

Drawings

Schematic diagram

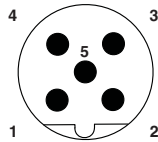

Pin assignment M12 socket, 5-pos., B-coded, female side

Schematic diagram

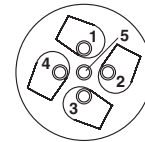

Cable connection side M12 (screw connection)

Dimensional drawing

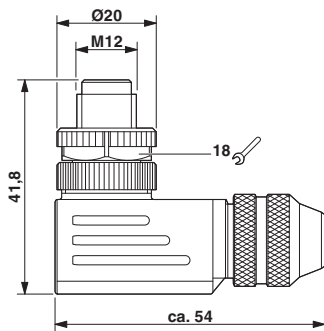

M12 x 1 male plug, angled, shielded

Functional drawing

Assembly steps for M 12 male/female connector and conductor

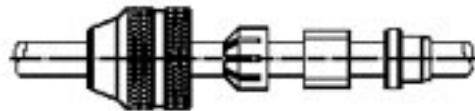

Slide parts onto the conductor

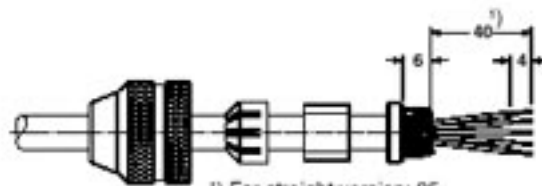

¹⁾ For straight version: 35

Strip conductor, widen shield and lay around the shielding ring, cut off projecting mesh.

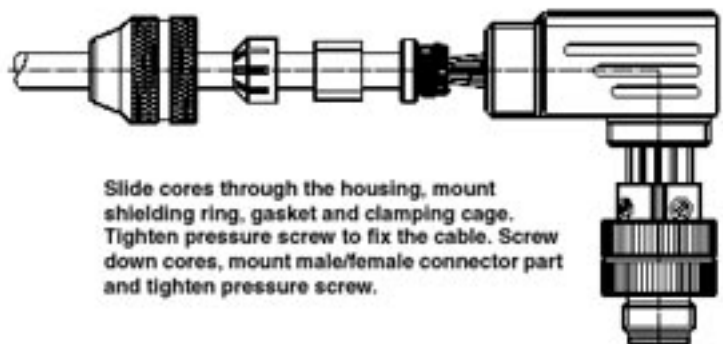

Slide cores through the housing, mount shielding ring, gasket and clamping cage. Tighten pressure screw to fix the cable. Screw down cores, mount male/female connector part and tighten pressure screw.

Phoenix Contact 2016 © - all rights reserved
<http://www.phoenixcontact.com>

PHOENIX CONTACT GmbH & Co. KG
Flachmarktstr. 8
32825 Blomberg
Germany
Tel. +49 5235 300
Fax +49 5235 3 41200
<http://www.phoenixcontact.com>



Below is a list of articles with direct links to our shop Electric Automation Network where you can see:

- Quote per purchase volume in real time.
- Online documentation and datasheets of all products.
- Estimated delivery time enquiry in real time.
- Logistics systems for the shipment of materials almost anywhere in the world.
- Purchasing management, order record and tracking of shipments.

To access the product, [click on the green button.](#)

Product	Code	Reference	Product link
Bus system connector, PROFIBUS, 5-position, shielded, Plug angled M12, B-coded, Screw connection, Knurl material: Zinc die-cast, nickel-plated, Cable gland Pg9, External cable diameter 6 mm ... 8 mm	1430417	SACC-M12MRB-5CON-PG9-SH	Buy on EAN