



Automatización Eléctrica
Especialistas en Automatización

At the end of this document you will find links to products related to this catalog. You can go directly to our shop by clicking [HERE](#). [HERE](#)

Cable gland - G-ESISEC-M12-S68N-NEPDS-S - 1415148

Please be informed that the data shown in this PDF Document is generated from our Online Catalog. Please find the complete data in the user's documentation. Our General Terms of Use for Downloads are valid (<http://phoenixcontact.com/download>)



Cable gland, Cable gland material: Nickel-plated brass, Application: Ex, External cable diameter 4 mm ... 7 mm, Shielding: yes, Connecting thread: M12, Color: silver

The figure shows the G-ESIS-M25-M68N-NEPDS-S version

Why buy this product

- Dust protection during storage and transport provided by a dust cap.



Key Commercial Data

Packing unit	10 STK
GTIN	 4 055626 037929

Technical data

Dimensions

Length	30 mm
Wrench size, union nut	16 mm
Wrench size, support	16 mm
Hexagon angular dimension GRP	18 mm
Length of the connecting thread	12 mm
External cable diameter	4 mm ... 7 mm

Ambient conditions

Degree of protection	IP66
	IP68 (5 bar / 0.5 h)
Ambient temperature (operation)	-40 °C ... 75 °C

General

Cable gland material	Nickel-plated brass
Seal material	EPDM

Cable gland - G-ESISEC-M12-S68N-NEPDS-S - 1415148

Technical data

General

Cable seal material	EPDM
O-ring material	EPDM
Thread type on connection side	M12
Torque	4 Nm (Support)
Tightening torque, union nut	4.00 Nm
Color	silver
Manufacturer	WISKA
Manufacturer Designation	EMSKE-L 12 EMV-Z

Standards and Regulations

ATEX	II 2 G/D EEx e II IP68
IECEX	Ex e IIC Gb, Ex tb IIIC Db

Classifications

eCl@ss

eCl@ss 5.1	27149109
eCl@ss 6.0	27149109
eCl@ss 8.0	27149109

ETIM

ETIM 5.0	EC000441
----------	----------

Approvals

Approvals

Approvals

UL Recognized / cUL Recognized / cULus Recognized

Ex Approvals

ATEX / IECEX / EAC Ex / GL

Approvals submitted

Approval details

UL Recognized

Cable gland - G-ESISEC-M12-S68N-NEPDS-S - 1415148

Approvals

cUL Recognized

cULus Recognized

Drawings

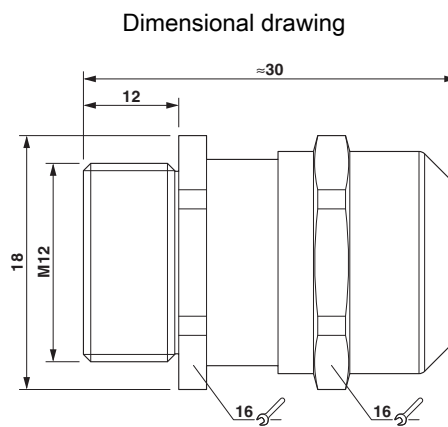

Phoenix Contact 2016 © - all rights reserved
<http://www.phoenixcontact.com>

PHOENIX CONTACT GmbH & Co. KG
Flachsmarktstr. 8
32825 Blomberg
Germany
Tel. +49 5235 300
Fax +49 5235 3 41200
<http://www.phoenixcontact.com>

Below is a list of articles with direct links to our shop Electric Automation Network where you can see:

- Quote per purchase volume in real time.
- Online documentation and datasheets of all products.
- Estimated delivery time enquiry in real time.
- Logistics systems for the shipment of materials almost anywhere in the world.
- Purchasing management, order record and tracking of shipments.

To access the product, [click on the green button.](#)

Product	Code	Reference	Product link
Cable gland, Cable gland material: Nickel-plated brass, Application: Ex, External cable diameter 4 mm ... 7 mm, Shielding: Yes, Connecting thread: M12, Color: silver	1415148	G-ESISEC-M12-S68N-NEPDS-S	Buy on EAN