

OMRON

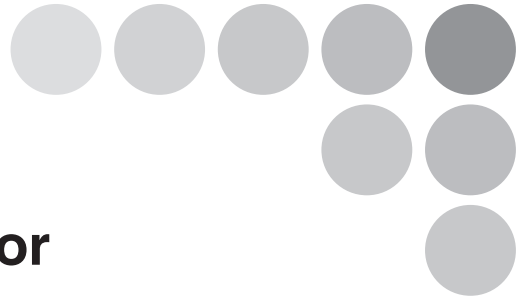

Communication Unit For Digital Type Sensor

E3X-DRT21-S (DeviceNet)

User's Manual

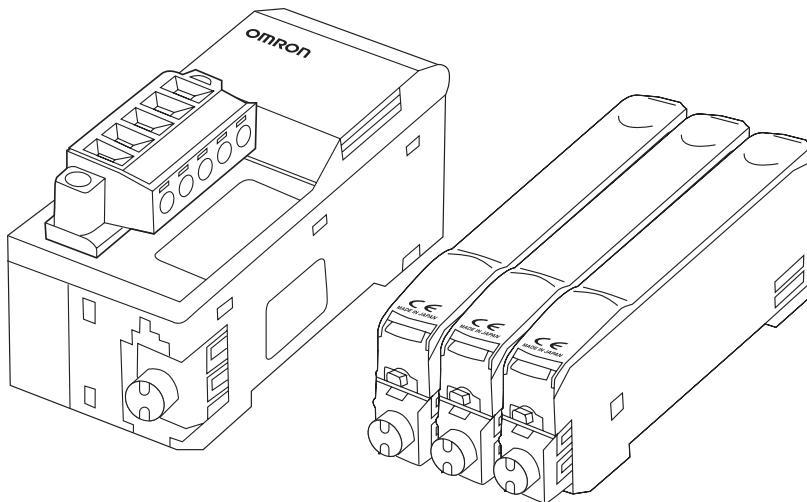

Cat. No. Z223-E1-03

Introduction

This manual provides information regarding functions, performance and operating methods that are required for using Communication Unit for Digital Type Sensor E3X-DRT21-S (DeviceNet).

This communication unit is a communication unit to be used for Digital Type Sensor E3X-DA-S Series, E3X-MDA Series, Digital Separate Amplifier Laser Sensor E3C-LDA Series, and Digital Separate Amplifier Proximity Sensor E2C-EDA Series, which had been developed with Omron's advanced technologies and successful experience.

● Intended Audience

This manual is intended for the following personnel, who must also have knowledge of electrical systems (an electrical engineer or the equivalent).

- Personnel in charge of installing FA systems.
- Personnel in charge of designing FA systems.
- Personnel in charge of managing FA systems and facilities.
- Note that this product must be used in the range of the general specifications.

● Version Upgrades

The software version will be upgraded as required. Versions are indicated in the model number as follows: E3X-DRT21-S Ver.□.

● Copyrights and Trademarks

DeviceNet is a registered trademark of the ODVA (Open DeviceNet Vendor Association). Other product names and company names used in this manual are the trademarks or registered trademarks of the respective companies. The copyright to the Communication Unit for Digital Type Sensor belongs to OMRON Corporation.

Introduction	Application Considerations (Please Read)	Introduction
Section 1	Overview	Section 1
Section 2	Installation and Connection	Section 2
Section 3	DeviceNet Communication Settings	Section 3
Section 4	APPENDIX	Section 4

User's Manual

Communication Unit
for Digital Type Sensor
E3X-DRT21-S (DeviceNet)

READ AND UNDERSTAND THIS DOCUMENT

Please read and understand this document before using the products. Please consult your OMRON representative if you have any questions or comments.

WARRANTY

OMRON's exclusive warranty is that the products are free from defects in materials and workmanship for a period of one year (or other period if specified) from date of sale by OMRON.

OMRON MAKES NO WARRANTY OR REPRESENTATION, EXPRESS OR IMPLIED, REGARDING NON-INFRINGEMENT, MERCHANTABILITY, OR FITNESS FOR PARTICULAR PURPOSE OF THE PRODUCTS. ANY BUYER OR USER ACKNOWLEDGES THAT THE BUYER OR USER ALONE HAS DETERMINED THAT THE PRODUCTS WILL SUITABLY MEET THE REQUIREMENTS OF THEIR INTENDED USE. OMRON DISCLAIMS ALL OTHER WARRANTIES, EXPRESS OR IMPLIED.

LIMITATIONS OF LIABILITY

OMRON SHALL NOT BE RESPONSIBLE FOR SPECIAL, INDIRECT, OR CONSEQUENTIAL DAMAGES, LOSS OF PROFITS OR COMMERCIAL LOSS IN ANY WAY CONNECTED WITH THE PRODUCTS, WHETHER SUCH CLAIM IS BASED ON CONTRACT, WARRANTY, NEGLIGENCE, OR STRICT LIABILITY.

In no event shall responsibility of OMRON for any act exceed the individual price of the product on which liability is asserted.

IN NO EVENT SHALL OMRON BE RESPONSIBLE FOR WARRANTY, REPAIR, OR OTHER CLAIMS REGARDING THE PRODUCTS UNLESS OMRON'S ANALYSIS CONFIRMS THAT THE PRODUCTS WERE PROPERLY HANDLED, STORED, INSTALLED, AND MAINTAINED AND NOT SUBJECT TO CONTAMINATION, ABUSE, MISUSE, OR INAPPROPRIATE MODIFICATION OR REPAIR.

SUITABILITY FOR USE

THE PRODUCTS CONTAINED IN THIS DOCUMENT ARE NOT SAFETY RATED. THEY ARE NOT DESIGNED OR RATED FOR ENSURING SAFETY OF PERSONS, AND SHOULD NOT BE RELIED UPON AS A SAFETY COMPONENT OR PROTECTIVE DEVICE FOR SUCH PURPOSES.

Please refer to separate catalogs for OMRON's safety rated products.

OMRON shall not be responsible for conformity with any standards, codes, or regulations that apply to the combination of products in the customer's application or use of the product.

At the customer's request, OMRON will provide applicable third party certification documents identifying ratings and limitations of use that apply to the products. This information by itself is not sufficient for a complete determination of the suitability of the products in combination with the end product, machine, system, or other application or use.

The following are some examples of applications for which particular attention must be given. This is not intended to be an exhaustive list of all possible uses of the products, nor is it intended to imply that the uses listed may be suitable for the products:

- Outdoor use, uses involving potential chemical contamination or electrical interference, or conditions or uses not described in this document.
- Nuclear energy control systems, combustion systems, railroad systems, aviation systems, medical equipment, amusement machines, vehicles, safety equipment, and installations subject to separate industry or government regulations.
- Systems, machines, and equipment that could present a risk to life or property.

Please know and observe all prohibitions of use applicable to the products.

NEVER USE THE PRODUCTS FOR AN APPLICATION INVOLVING SERIOUS RISK TO LIFE OR PROPERTY WITHOUT ENSURING THAT THE SYSTEM AS A WHOLE HAS BEEN DESIGNED TO ADDRESS THE RISKS, AND THAT THE OMRON PRODUCT IS PROPERLY RATED AND INSTALLED FOR THE INTENDED USE WITHIN THE OVERALL EQUIPMENT OR SYSTEM.

PERFORMANCE DATA

Performance data given in this document is provided as a guide for the user in determining suitability and does not constitute a warranty. It may represent the result of OMRON's test conditions, and the users must correlate it to actual application requirements. Actual performance is subject to the OMRON Warranty and Limitations of Liability.

CHANGE IN SPECIFICATIONS

Product specifications and accessories may be changed at any time based on improvements and other reasons.

It is our practice to change model numbers when published ratings or features are changed, or when significant construction changes are made. However, some specifications of the product may be changed without any notice. When in doubt, special model numbers may be assigned to fix or establish key specifications for your application on your request. Please consult with your OMRON representative at any time to confirm actual specifications of purchased products.

DIMENSIONS AND WEIGHTS

Dimensions and weights are nominal and are not to be used for manufacturing purposes, even when tolerances are shown.

ERRORS AND OMISSIONS

The information in this document has been carefully checked and is believed to be accurate; however, no responsibility is assumed for clerical, typographical, or proofreading errors, or omissions.

PROGRAMMABLE PRODUCTS

OMRON shall not be responsible for the user's programming of a programmable product, or any consequence thereof.

COPYRIGHT AND COPY PERMISSION

This document shall not be copied for sales or promotions without permission.

This document is protected by copyright and is intended solely for use in conjunction with the product. Please notify us before copying or reproducing this document in any manner, for any other purpose. If copying or transmitting this document to another, please copy or transmit it in its entirety.

Meanings of Signal Words

The following signal words are used in this manual.



Indicates a potentially hazardous situation which, if not avoided, will result in minor or moderate injury, or may result in serious injury or death. Additionally there may be significant property damage.

Alert statements in this Manual

The following alert statements apply to the products in this manual. Each alert statement also appears at the locations needed in this manual to attract your attention.



Configure the safety circuits, such as emergency stop circuits, interlock circuits, and limit circuits, with external control circuits in order to remain the safety of the entire system when a failure due to a product failure or an external factor occurs. If not, the failure may cause a serious incident.

Precautions for Safe Use

Please observe the following precautions for safe use of E3X-DRT21-S.

- Do not use the product in environments where it can be exposed to inflammable/explosive gas.
- Do not use the product where to be exposed to water, oil, chemical fumes or steam.
- Do not disassemble, repair or modify this product.
- Do not wire the product when the power is ON.
- Do not drop, or subject to excessive shock or vibration. It may cause a failure or abnormal operation.
- Use the specified communications cables.
- Wire communications within the specified distance.
- Do not wire the communications cables near or in parallel with high-voltage or high-current lines.
- Do not bend cables past their natural bending radius or pull on cables.
- Check all wiring carefully and completely before supplying power.
- Confirm that the correct polarity has been used in wiring the terminals and that the communications and power lines have been otherwise wired correctly. Incorrect wiring may result in failure.
- Do not connect or disconnect connectors while the power supply is turned ON. Doing so may result in failure or malfunction.
- Use the specified power supply voltage.
- Do not turn ON or OFF the power supply to the Mobile Console during communications. Doing so may result in communications errors.
- Make sure that screws for the communication connector are tightened firmly. (0.5 N·m to 0.6N·m)
- Do not use this product if the case is damaged.
- Dispose this product as industrial waste.

Precautions for Correct Use

Please install this product correctly according to this manual.

- Do not install the product in locations subjected to the following conditions:
 - Direct sunlight
 - Ambient temperature and humidity outside the rating
 - Rapid temperature transition and condensation
 - Excessive dust, saline air or metal powder
 - Direct vibration or shock

- Use appropriate shielding when using this product in the following places.
 - Presence of noise such as static electric
 - Strong magnetic or electric field
 - Subject to possible expose to radiation
 - Near power supply lines

- Do not clean with organic solvents, such as paint thinner. Organic solvents will dissolve and discolor the surface of the product.

- Take measures to stabilize the power supply to conform to the rated supply (the voltage, frequency, etc.) if it is not stable.

Editor's Note

Page Format

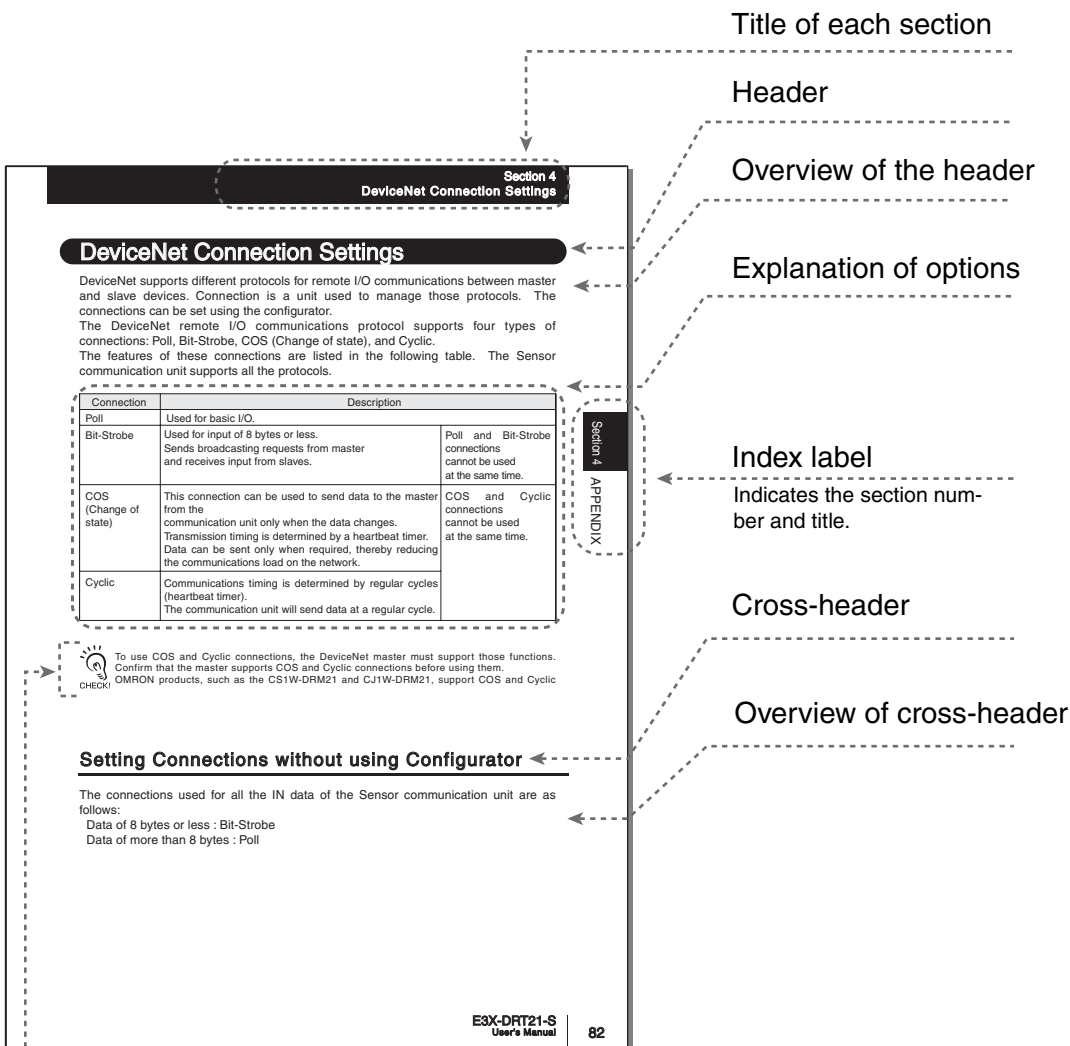

Supplementary Explanation

Helpful information regarding operation and reference pages introduced here using symbols.



* This page does not exist.

■ Meaning of Symbols

Menu items that are displayed on the Amplifier Unit's LCD screen are indicated enclosed by brackets [].

■ Visual Aids



CHECK!

Indicates points that are important to ensure full product performance, such as operational precautions and application procedures.



Indicates pages where related information can be found.



Indicates information helpful in operation.

EXP MENU

Indicates functions that can be set only when the setup menu has been switched to EXP menu.

MEMO

Contents

Meanings of Signal Words	5
Precautions for Safe Use	6
Precautions for Correct Use	7
Editor's Note	8
Page Format	8
Contents	11
Section 1 Overview	15
Features and System Configuration	16
Overview	16
Features	17
System Configuration	18
Section 2 Installation and Connection	19
Specifications and External Dimensions	20
Specifications	20
External Dimensions	21
Connecting Sensors	22
Connectable Sensors	22
Number of Connectable Sensors	23
Connecting and Identifying Sensors (Unit Number)	23
Registering the Number of Connected Sensors	24
Sensor Reset Switch	24
Installation	25
Installation Procedures	25
Removing Procedures	26
Precautions for Replacing Units	26

Section 3 DeviceNet Communication Settings	27
Overview of DeviceNet Communication Type	28
Overview	28
Overview of Communication Functions of DeviceNet Communication Type	29
Example of Remote I/O Communications	32
Example of Explicit Message Communications	33
Part Names	34
Part Names and Functions	34
How to Use Units	37
How to Use Units	37
Wiring DeviceNet Communication Type	39
DeviceNet Remote I/O Communications	40
Allocating to Master	40
Explicit Message Communications	44
Basic Format of Explicit Messages	44
Read Commands	46
Write Commands	60
Operation Instruction Commands	70
Error Code List	72
Example of Explicit Message Functions	74
Sensor Setting/Monitoring/Operating Functions from Configurator	76
Overview	76
Setting the Communication Unit and Sensors, and Downloading	78
Uploading to Communication Unit and Monitoring/Setting Parameters Online	80
Operation Instructions for Each Sensor (Fiber Amplifier Unit)	81
Online Monitoring	82
Sensor Maintenance	82

Section 4 APPENDIX	83
Communications Timing	84
Communications Timing	84
Errors and Countermeasures	86
DeviceNet Connection Settings	88
Setting Connections without Using Configurator	88
Changing Connections Using the Configurator	89
DeviceNet Device Profile	95
Device Profile	95
Mounted Objects	96
Index	97
Revision History	100

MEMO

Section 1

Overview

 Features and System Configuration	16
Overview	16
Features	17
System Configuration	18

Features and System Configuration

Overview

The Communication Unit (E3X-DRT21-S) is a communication slave that performs the ON/OFF output for sensors, monitoring the detection level, writing parameters, and an operation between Digital Type Sensors and PLCs via DeviceNet communication. (Supported sensors are: Fiber Sensors E3X-DA-S/MDA series, Separate Amplifier Laser Sensors E3X-LDA series, and Separate Amplifier Proximity Sensor E2C-EDA series.)

The ON/OFF output and monitoring the detection level can be performed using remote I/O communications without any programming. Moreover, reading and writing any parameters using Explicit messages, and batch-transfer and monitoring any parameters using a configurator are possible.



If the Sensor is connected using a connector with a cable, external noise may prevent correct communication of ON/OFF signals to the Communication Unit. If a high level of reliability is required, use a cordless connector (E3X-CN02).

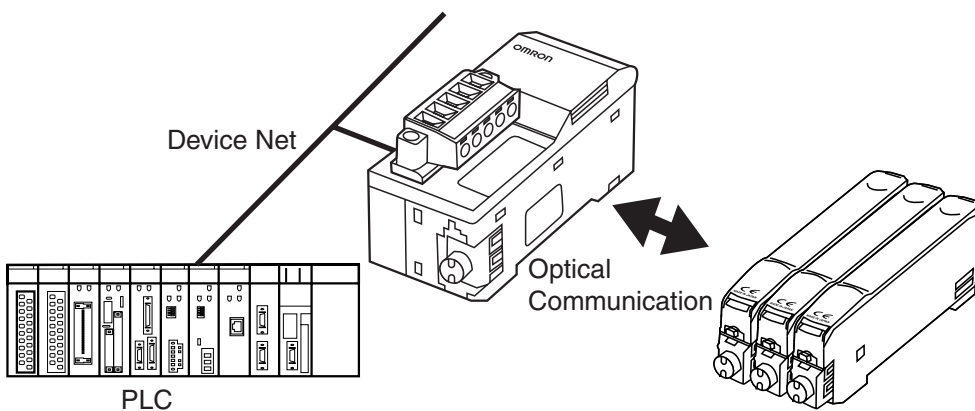

Features

- **This unit enables a communication interface between OMRON's PLCs (CS, CJ, SYSMAC and other series) or other manufacturer's PLCs that support DeviceNet, and Digital Type Sensors.**

- **Remote I/O communication slave**

Data such as ON/OFF output and the detection level on Digital Type Sensors can be sent to the upper (master) PLCs via remote I/O communication without any programming.

- **Message communications**

Sending commands (Explicit messages) from the PLC allows reading and writing parameters such as settings of the detection level, threshold and each function, and various teaching operations.

- **Configurator**

By using configurators (version 2.10 or later) connected to the network on PCs, parameters for each device (DeviceNet-supported products including sensors, temperature controller, etc.) can be set to download them to all devices all at once. Moreover, the ON/OFF output and monitoring the detection level for sensors, and teaching operations can be performed.

- **Monitoring sensor's operating time**

Operating time (Turn-on time) for Amplifier Unit of sensors and Sensor Heads can be monitored respectively by configurators.

By setting the warning time, it is possible to indicate a warning that operating time exceeds the limit of the setting.

It is useful for a maintenance design for sensors.

- **Mobile console connection**

Mobile console E3X-MC11-SV2 for Digital Type Sensors can be connected to the Communication Unit. (Head unit for connecting the mobile console is not required.)



✓ The mobile console can be used in combination with monitoring ON/OFF output. However, it cannot be used in combination with monitoring the detection level, messages communications and device parameters transfer from the configurator.

CHECK!

System Configuration

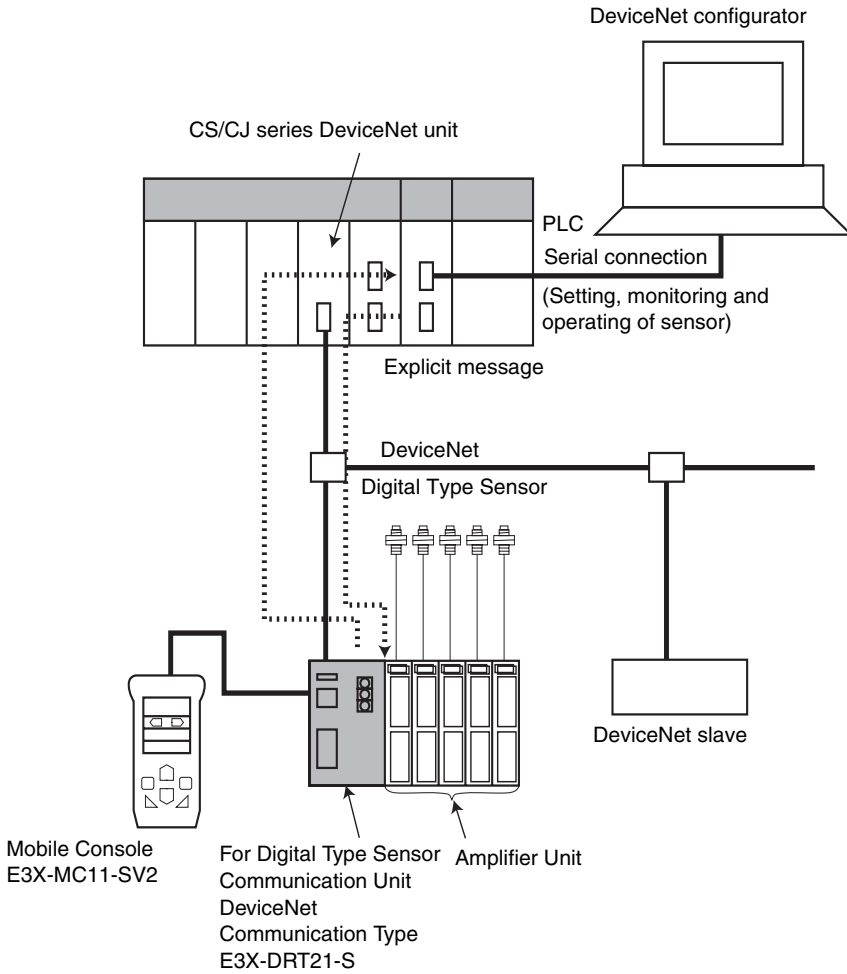

Mobile console cannot be used at the same time as explicit messages communications and setting, monitoring, and operating from the configurator.

CHECK!

Section 2

Installation and Connection

☒ Specifications and External Dimensions	20
Specifications	20
External Dimensions	21
☒ Connecting Sensors	22
Connectable Sensors	22
Number of Connectable Sensors	23
Connecting and Identifying Sensors (Unit Number)	23
Registering the Number of Connected Sensors	24
Sensor Reset Switch	24
☒ Installation	25
Installation Procedures	25
Removing Procedures	26
Precautions for Replacing Units	26

Specifications and External Dimensions

Specifications

Item		Description
Communications method		DeviceNet Communications
Communi- cations	Remote I/O communications	ON/OFF output, status, and monitoring the detection level (details of the digital display)
	Message communications	Setting parameters using Explicit messages
	Configurator	Editing parameters for slave devices using a configurator/It depends on device monitoring functions
Mobile console connection *2		E3X-MC11-SV2 can be connected (Note that it cannot be used in combination with monitoring detection level via remote I/O communications, Explicit message communications, and setting/monitoring/operating of Sensors from configurator)
Power supply		Supplies from DeviceNet communications connector (Power is supplied to all Sensors being connected via wire-saving connectors.)
Maximum number of connected Sensors		13 or 16 (depending on the operating mode) (Note that the Sensors that occupy the units for two must be counted as two units.)
Connectable Sensors		Fiber Sensors Separate Amplifier Laser Sensors Separate Amplifier Proximity Sensors Refer to <i>Connectable Sensors</i> on page 22 for details.
Power supply voltage		DC11 to 25 V
Current consumption *1		70 mA max.
Operating ambient temperature		-20 to +55°C
Operating ambient humidity		35% to 85% (with no condensation)
Storage ambient temperature		-30 to +70°C
Size (mm)		30.0 (W) x 34.6 (H) x 71.3 (D)
Weight **packed state		Approx. 150 g

*1. The current supplied to the Sensors is not included.

*2. E3X-DA7-S and E3X-DA9-S cannot be used.

External Dimensions

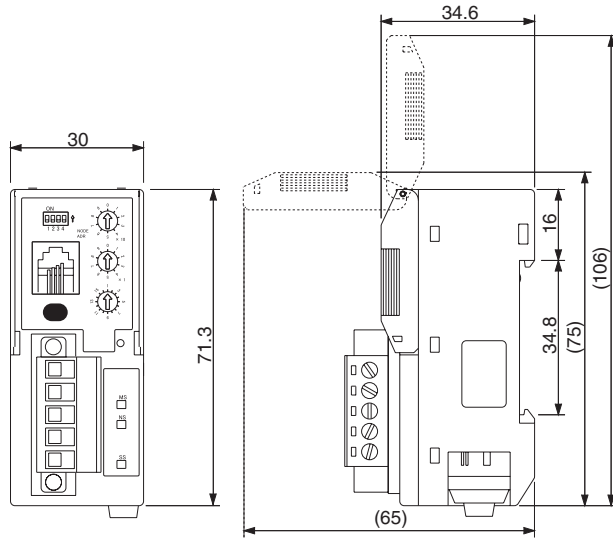

Connecting Sensors

Connectable Sensors

The Communication Unit can be connected with the following Sensors.

An optional reduced-wiring connector (i.e., slave connector or cordless connector) is required to connect the Sensor.

Type	Model	Types	Output type	Threshold value	Number of units occupied		
Fiber Sensors	E3X-DA7-S	Hi-grade type	NPN	2	2		
	E3X-DA9-S		PNP				
	E3X-DA6-S	Standard type	NPN	1	1		
	E3X-DA8-S		PNP				
	E3X-DAB6-S	For mark-detecting (Blue LED)	NPN				
	E3X-DAB8-S		PNP				
	E3X-DAG6-S	For mark-detecting (Green LED)	NPN				
	E3X-DAG8-S		PNP				
	E3X-DAH6-S	Infrared LED	NPN				
	E3X-DAH8-S		PNP				
	E3X-DA6TW-S	Advanced Two-output type	NPN			2	2
	E3X-DA8TW-S		PNP				
	E3X-DA6RM-S	Advanced External input type	NPN			1	1
	E3X-DA8RM-S		PNP				
	E3X-MDA6	2CH type	NPN			2	2
	E3X-MDA8		PNP				
Separate Amplifier Laser Sensors	E3C-LDA6	Two-output type	NPN			2	2
	E3C-LDA8		PNP				
	E3C-LDA7	External input type	NPN	1	1		
	E3C-LDA9		PNP				
Separate Amplifier Proximity Sensors	E2C-EDA6	Two-output type	NPN	2	2		
	E2C-EDA8		PNP				
	E2C-EDA7	External input type	NPN	1	1		
	E2C-EDA9		PNP				



- If the Sensor is connected using a connector with a cable, external noise may prevent correct communication of ON/OFF signals to the Communication Unit.

CHECK! • Note that prewired models cannot be connected. Connecting these units will disable the power reset function.

- E3X-DA-N series cannot be connected.
- Lot No. of E3X-DRT21-S must use it since November 1, 2008 when you use the function only of shape E3X-DA7 and E3X-DA9.

Number of Connectable Sensors

The number of connectable Sensors depends on the settings of communication units.

Type	Setting	Number of Connectable Sensors
DeviceNet Communication Type (E3X-DRT21-S)	Remote I/O communications in 1CH mode	Max. 13
	Remote I/O communications in 2CH mode or Remote I/O communications in 2CH mode with monitoring detection levels	Max. 16



The Sensors that are allocated two unit numbers must be counted as two units when counting the number of sensors.

CHECK!

Connecting and Identifying Sensors (Unit Number)

The Sensors are gang-mounted to the right side of the Communication Unit, as shown in the following diagram. DIN track must be used for installing.

Power to the connected Sensors is supplied from the Communication Unit.

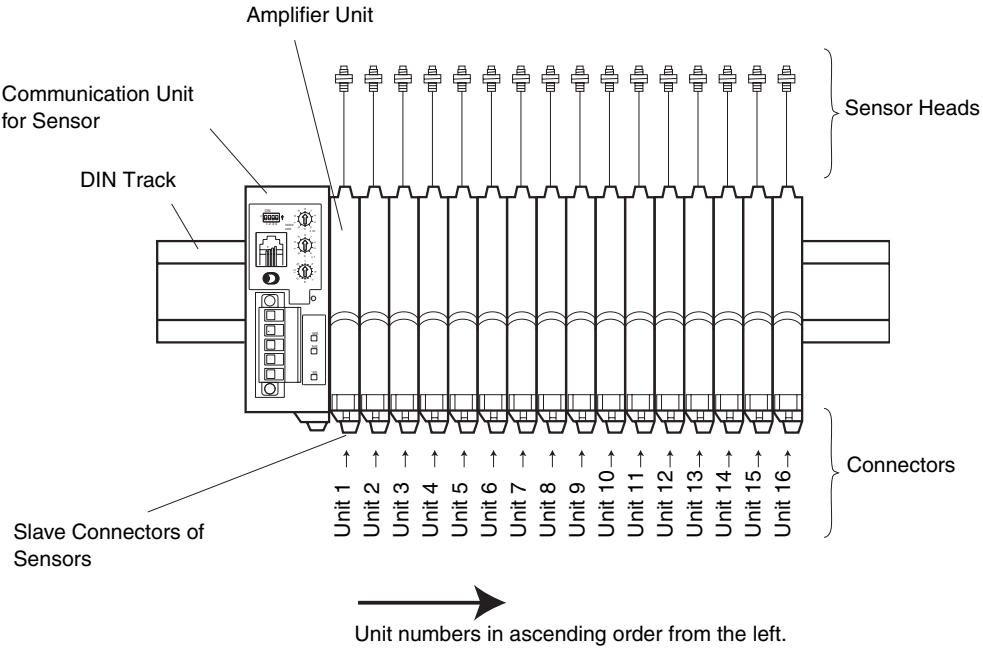

The Communication Unit identifies the connected Sensors according to the unit numbers. Unit numbers of sensors are assigned to the units from unit number 1 starting from the communication unit side. Note that some Sensors occupy two unit numbers.

Registering the Number of Connected Sensors

To detect whether communications between communication units and Sensors are normal, the number of connected Sensors must be registered.

By registering the number of Sensors connected, when there is no response on the optical communications of Sensors due to damage to the Sensors and so on, errors can be detected from the difference between the number of Sensors that can be communicated with and the number of Sensors registered.

When there is a difference between the number of Sensors connected and the number of Sensors registered, it is indicated as follows:

- The SS LED lights red.
- [Sensor Communication Error] Flag turns ON.

Setting the Number of Connected Sensors

Type	Setting method
E3X-DRT21-S (DeviceNet communications type)	Registering using rotary switch.



The Sensors that are allocated two unit numbers must be counted as two units when counting the number of sensors.

CHECK!

Sensor Reset Switch

Using the sensor reset switch allows you to replace and add Sensors without turning OFF the power for the communication unit.

After replacing the Sensors and so on, press the reset switch to reset all the Amplifier Units and restart normally the communications between the communications unit and Sensors.

Installation

Installation Procedures

Installation procedures are as follows:

1. Install the front part of the unit on the DIN track.

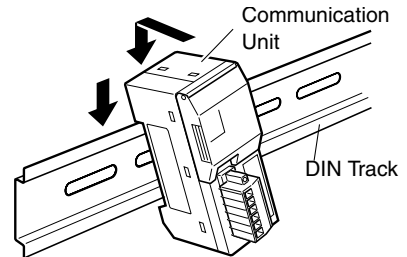

2. Press the rear part of the unit onto the DIN track.

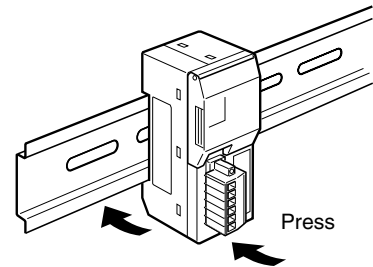

3. Slide the Sensor Amplifier Unit to fit the hook of the connector to the communication unit, and keep pushing until you hear it snap into place.

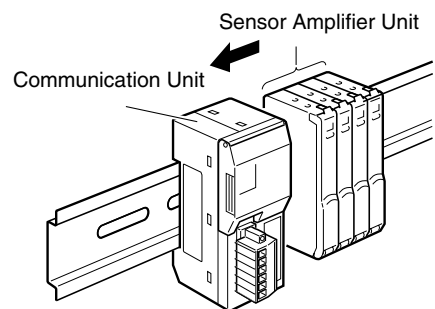

4. Fix the both ends firmly with End Plate (PFP-M, sold separately).

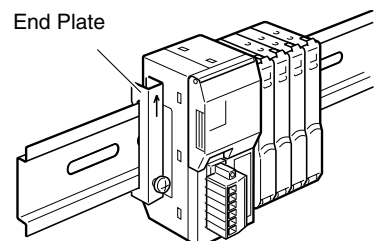



CHECK!

The order of steps 1 and 2 in the installation method described above must be followed correctly. Mounting strength may decrease if the order is not correct.

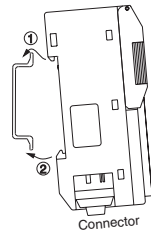

Order of step (1) to step (2)

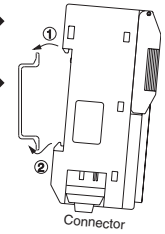

NG as the order of step (2) to step (1)

Removing Procedures

Removing procedures are as follows:

1. Slide the Sensor Amplifier Unit to remove it from the communication unit.

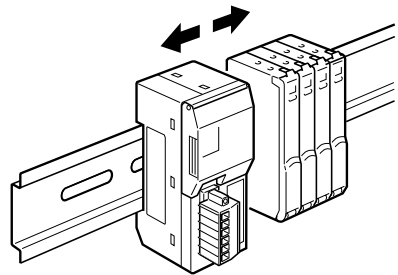

2. Keep pressing the communication unit in direction A and lift it up in direction B to remove.

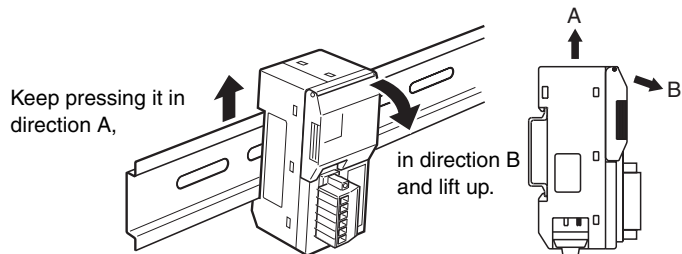

Precautions for Replacing Units

The following parameters have been stored into the internal memory of the communications unit. If the default value have been changed, these parameters must be set again when replacing units.

- Number of connected Sensors
- Number of monitors for the detection level

Section 3

DeviceNet Communication Settings

☒	Overview of DeviceNet Communication Type	28
	Overview	28
	Overview of Communication Functions of DeviceNet Communication Type	29
	Example of Remote I/O Communications	32
	Example of Explicit Message Communications	33
☒	Part Names	34
	Part Names and Functions	34
☒	How to Use Units	37
	How to Use Units	37
☒	Wiring DeviceNet Communication Type	39
☒	DeviceNet Remote I/O Communications	40
	Allocating to Master	40
☒	Explicit Message Communications	44
	Basic Format of Explicit Messages	44
	Read Commands	46
	Write Commands	60
	Operation Instruction Commands	70
	Error Code List	72
	Example of Explicit Message Functions	74
☒	Sensor Setting/Monitoring/Operating Functions from Configurator	76
	Overview	76
	Setting the Communication Unit and Sensors, and Downloading	78
	Uploading to Communication Unit and Monitoring/Setting Parameters Online	80
	Operation Instructions for Each Sensor (Fiber Amplifier Unit)	81
	Online Monitoring	82
	Sensor Maintenance	82

Overview of DeviceNet Communication Type

Overview

A DeviceNet Communication Type is a communication unit to output ON/OFF data of multiple fiber sensors, monitor the detection level, write parameters, and operate the unit via DeviceNet.

The ON/OFF output and monitoring the detection level can be performed using remote I/O communications without any programming. Moreover, reading and writing any parameters using Explicit messages, and batch-transfer and monitoring any parameters using a configurator are possible.



CHECK!

If the Sensor is connected using a connector with a cable, external noise may prevent correct communication of ON/OFF signals to the Communication Unit. If a high level of reliability is required, use a cordless connector (E3X-CN02).

When using this product, also refer to the following manuals:

"DeviceNet User's Manual" (No. W267), "DeviceNet Slave Manual" (No. W404)

Overview of Communication Functions of DeviceNet Communication Type

● Remote I/O Communications

The Communication Unit, E3X-DRT21-S, can allocate sensor ON/OFF output data, status, and the detection level to the master IN area.

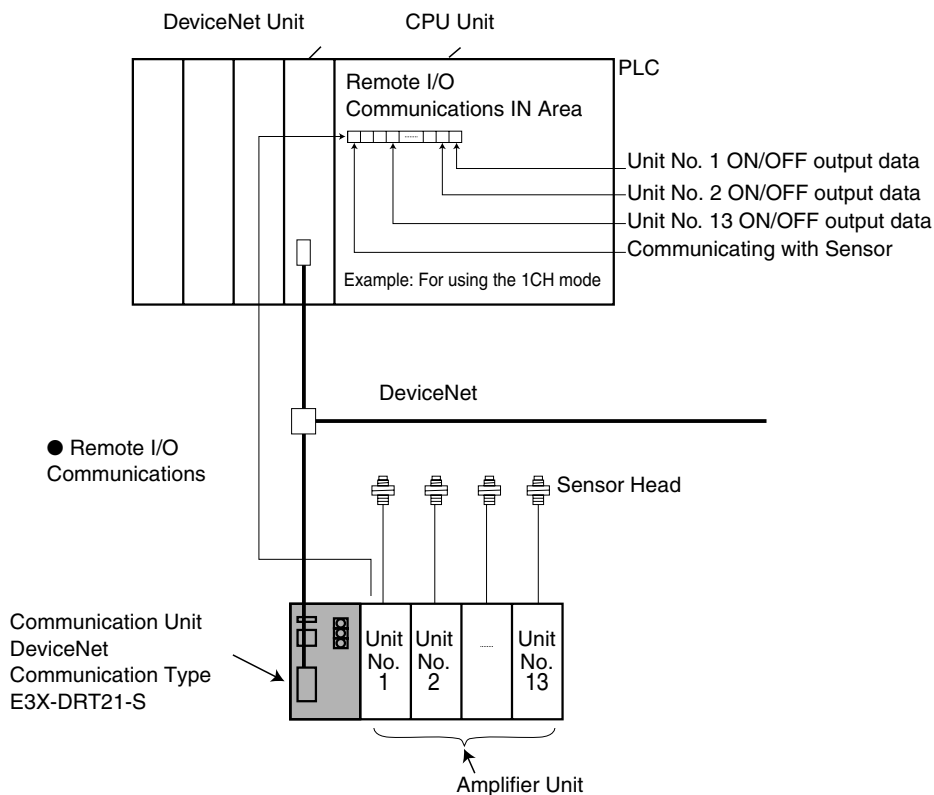

Communication Mode	Occupied CH	Communication Data	Number of Sensors That Can Be Connected	Condition
Remote I/O Communications 1CH mode	IN Area 1CH	Sending the following data to the master unit: - ON/OFF output data for maximum 13 units	Max. 13	-
Remote I/O Communications 2CH mode	IN Area 2CH	Sending the following data to the master unit: - ON/OFF output data for maximum 16 units - Number of sensors that can be communicated with - Number of connected Sensors	Max. 16	
Remote I/O Communication 2CH + Detection level Monitor mode	IN Area 2CH + Connected Sensors Unit CH	Sending the following data to the master unit: - ON/OFF output data for maximum 16 units - Number of sensors that can be communicated with - Number of connected Sensors - Detection level of maximum 16 sensors	Max. 16	Not allowed to monitor the detection level when connected to Mobile Console.

● **Explicit Message Communications**

Any parameters of the connected sensors can be read or written by issuing commands of Explicit messages to the Communication Unit (E3X-DRT21-S).

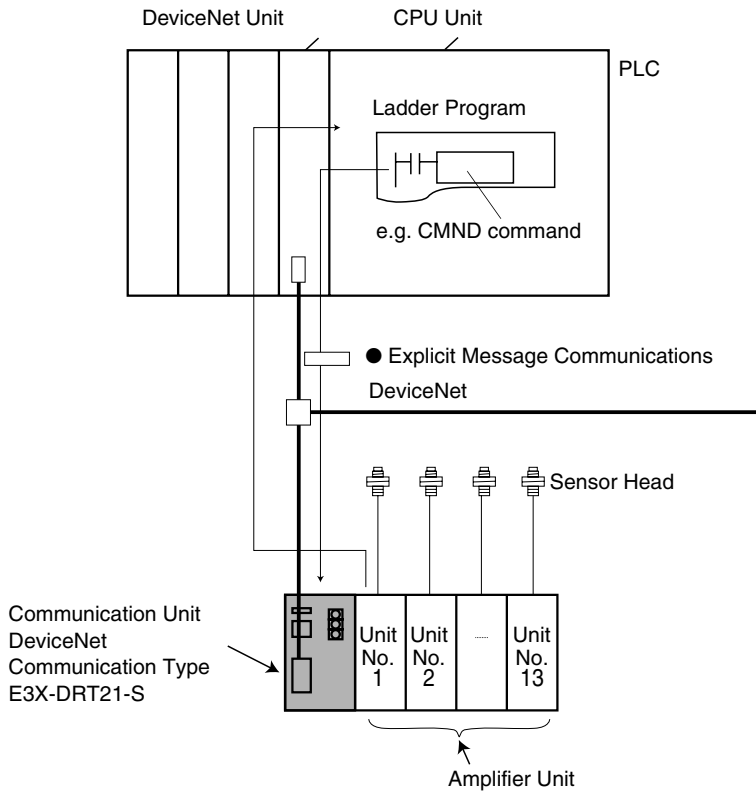

Type	Communication Data	Condition
Sends an Explicit Read command	Reads any parameters such as the ON/OFF output data, the detection level, and threshold values	Not allowed when connected with the Mobile Console.
Sends an Explicit Write command	Writes (sets) any parameters such as threshold values	
Sends an Explicit Operation Instruction command	Various operations such as teaching	

● **Transferring, Monitoring, and Operating from the Configurator**

A DeviceNet Configurator (Ver. 2.10 or higher) can be used to read and write Sensor parameters from a personal computer.

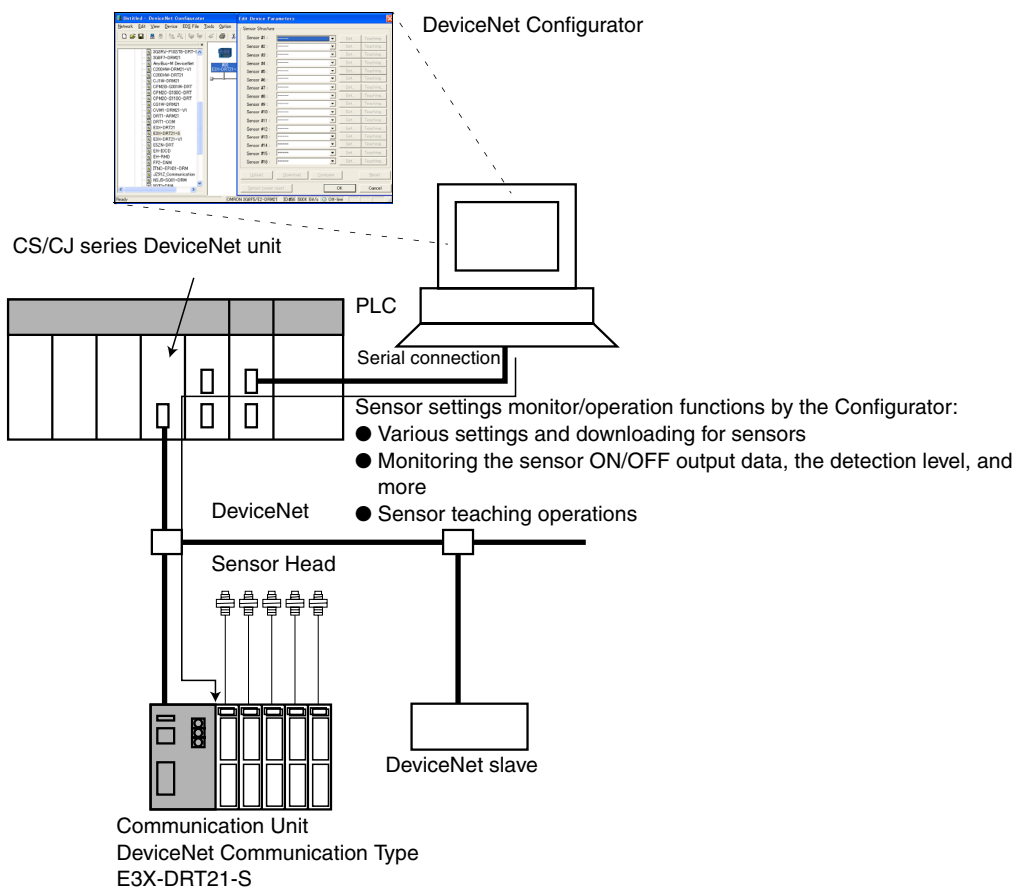

Type	Communication Data	Condition
Sensor parameter setting	Writes (sets) any parameters such as threshold values	Not allowed when connected with the Mobile Console
Sensor monitoring	Reads any parameters such as the ON/OFF output data, the detection level, and threshold values	
Sensor teaching	Performs various teaching operations	

Example of Remote I/O Communications

Example: When monitoring sensor ON/OFF output state of unit No. 1

When using the 1CH mode (SW1=OFF, SW2=OFF)

When E3X-DRT21-S DeviceNet node address is 00.

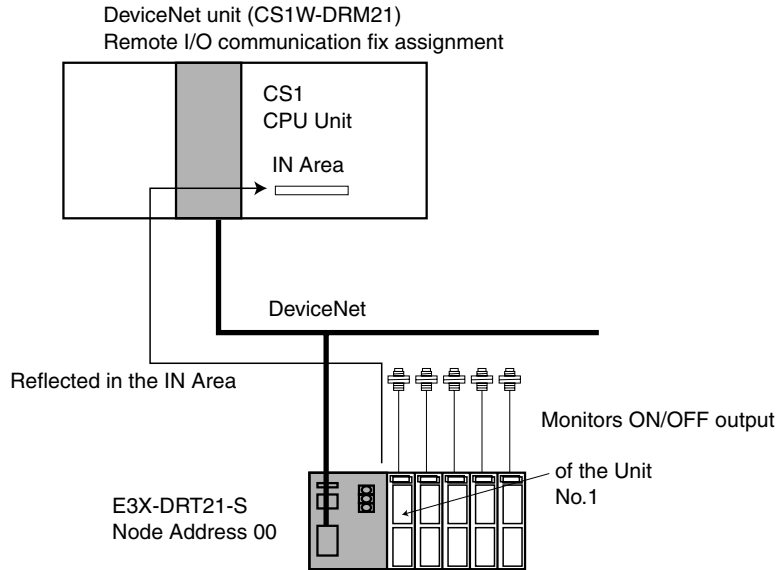

IN Area (Fix Assignment 1)

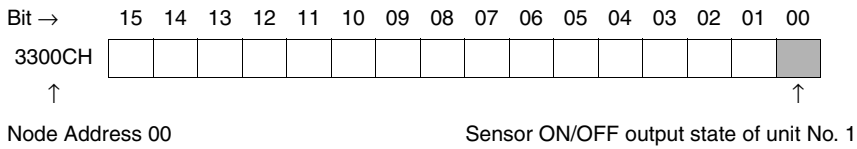

Example of Explicit Message Communications

Example: When setting maximum sensitivity to unit No. 1

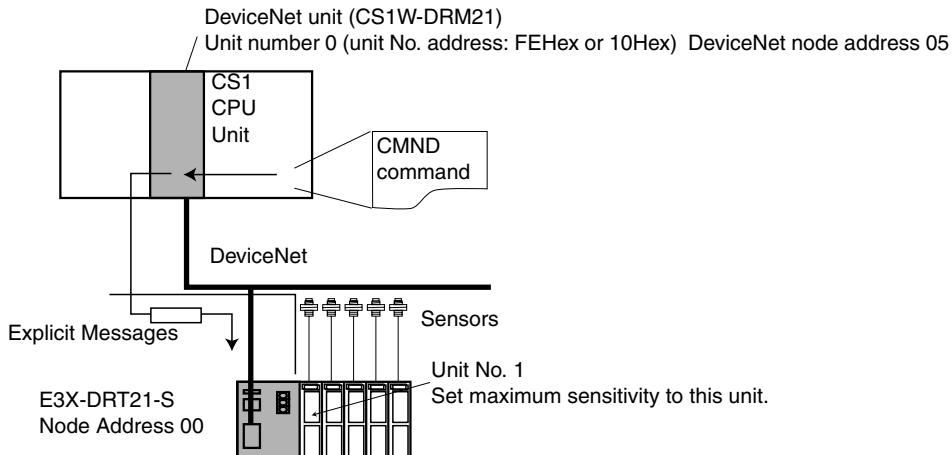

• Command Format for Setting Maximum Sensitivity

Send the following Explicit messages:

Destination Node Address	Service Code	Class ID	Instance ID	Attribute ID
00Hex	16 Hex	009EHex	0001Hex	30Hex

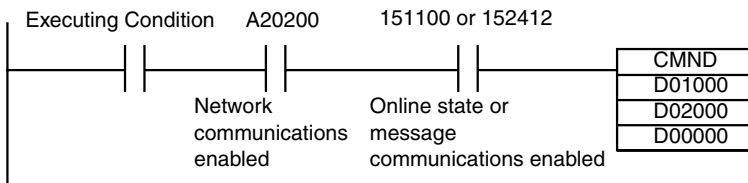

Command data of 10 bytes from D01000 is sent to destination node address 05, then its response data of 10 bytes is stored into D02000 of the local node (D00000 is control data)

S:	D01000	2	8	0	1	Command code
	D01001	0	0	1	6	Slave node address: 00, ServiceCode: 16Hex
	D01002	0	0	9	C	ClassID: 009CHex
	D01003	0	0	0	1	InstanceID: 0001Hex (unit No.)
	D01003	3	0	0	0	Data: 30Hex (Fixed)
D:	D02000					Head CH number for response store
C:	D00000	0	0	0	9	Byte length of command data: 9
	D00001	0	0	0	A	Byte length of response data
	D00002	0	0	0	1	Destination network address: 1
	D00003	0	5	F	E	Destination DeviceNet node address: 05Hex Destination unit No. address: FEHex (10Hex is also acceptable)
	D00004	0	0	0	0	Response required, communication port No. 0, retry number: 0Hex
	D00005	0	0	C	8	Response monitoring timer: 20 seconds

Part Names

Part Names and Functions

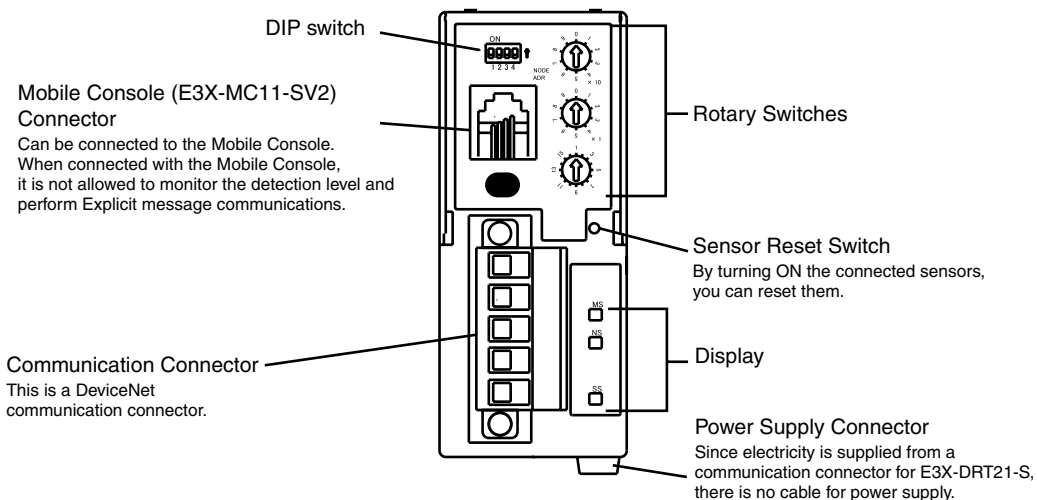

- When connected with the Mobile Console that is turned on, "sensor communications error" occurs if the any of the following conditions is realized:
 - When you turn OFF the Mobile Console.
 - When the Mobile Console is left electrified, automatically the power is turned OFF.
 - When the power is turned OFF due to low battery of the Mobile Console.

Make sure any of the above conditions will not occur.

■ Indicator (LED)

The following table shows the operation of the indicators.



LED Name	Name	LED Color	Status	Description
MS	Module Status	Green	Lit	Normal operation
			Flashing	Not set
		Red	Lit	Fatal error
			Flashing	Non-fatal error
		—	Not lit.	Power OFF
NS	Network Status	Green	Lit	DeviceNet online/connected
			Flashing	DeviceNet online/not-connected
		Red	Lit	DeviceNet fatal communication error
			Flashing	DeviceNet non-fatal communication error
		—	Not lit.	DeviceNet offline/power OFF
SS	Sensor Communication Status	Green	Lit	Communicating with Sensor
		Red	Lit	Sensor communications error
		—	Not lit.	Waiting for communications with the sensors/ power OFF

● Normal State of LEDs

MS	Green is lit when normal
NS	Green is lit: normal (online/connected)
SS	Green is lit when communicating with a sensor

■ Switches

● Rotary Switches

-  x10 } DeviceNet node address setting
 Sets the DeviceNet node address.
 Range: Between 00 and 63 (cannot be set between 64 and 99)
-  x 1 } Registering the Number of Connected Sensors
 Registers the number of sensors to be connected. Registering the number of the sensors enables you to detect configuration failure when it occurs.



The Sensors that are allocated two unit numbers must be counted as two units when counting the number of sensors.

CHECK!

● **DIP switch**

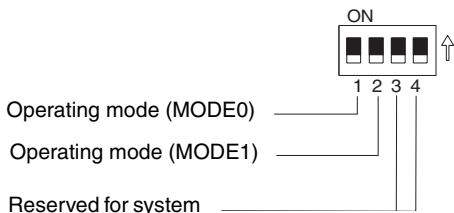

● **Operating Mode Settings (SW1, SW2)**

These switches set the operating mode. However, data type assigned to the master IN area varies on the operating mode. For details, see “DeviceNet Remote I/O Communications” on p. 40.

SW1 (MODE0)	SW2 (MODE1)	Operating Mode Settings	Number of Sensors that Can Be Connected
OFF	OFF	Remote I/O communications 1CH mode	Max. 13
ON	OFF	Remote I/O communications 2CH mode	Max. 16
OFF	ON	Remote I/O communications 2CH + detection level monitor mode	Max. 16
ON	ON	Cannot be set.	—



The Sensors that are allocated two unit numbers must be counted as two units when counting the number of sensors.

CHECK!

● **Reserved for system use (SW3, SW4)**

These pins must always be OFF.

● **Sensor Reset Switch**

Press this switch to reset power of connected sensors. Use this switch when the following occurs:





- When the number of connected sensors doesn't match the number of sensors that can be communicated, one or more sensors might have been released. If so, mount all of the displaced sensors correctly, and then reset the power to establish communications between sensors again. If the power is turned off, the communication unit is released from DeviceNet, which might affect the entire system; by this switch, reestablish communications between the sensors.



In E3X-DRT21-S, DeviceNet baud rate is automatically changed to baud rate of the master. Therefore, the DIP switch is not required to set the baud rate.

How to Use Units

How to Use Units

Step	Item	Description			
1	Mount the Communication Unit to the DIN Track	Mount this unit to the DIN track. After the Sensor Amplifier Unit is mounted to the DIN track, gang-mount the Sensor Amplifier Unit.  When you dismount a unit from the track, slide the body, disconnect the connection, and then dismount it from the DIN track. CHECK!			
2	Connect Sensors to the Communication Unit	Slide the Communication Unit, touch its edge clip onto the sensor amplifier unit, and then stick it to the amplifier unit tightly until a clinking noise is heard.			
3	Set the Sensors to "RUN" Mode	By using the mode switch, set "RUN" mode.			
4	DeviceNet Connecting a Communication Connector	Connect a connector for DeviceNet communication.  DeviceNet Communication Power Supply (V+, V-) provides DC electricity to the Communication Unit and all connected sensors. CHECK!			
5	Set the Rotary Switches	Two upper switches	Set the DeviceNet node address (between 0 and 63).		
		One lower switch	Set the number of connected sensors (between 1 and 16)  The Sensors that are allocated two unit numbers must be counted as two units when counting the number of sensors. CHECK!		
6	Set the DIP Switches	SW1	SW2	Operating Mode Settings	Number of Sensors that Can Be Connected
		OFF	OFF	Remote I/O Communications 1CH mode	Max. 13
		ON	OFF	Remote I/O Communications 2CH mode	Max. 16
		OFF	ON	Remote I/O Communications 2CH mode + detection level monitoring	Max. 16
7	DC Power Supply Turn on DeviceNet Communication Power Supply (V+, V-)	 <ul style="list-style-type: none"> Set the sensors to [RUN] mode. When DC power is turned on, do not connect the Mobile Console E3X-MC11-SV2. If you do, "sensor communications error" occurs. CHECK!			
8	Check the LEDs	MS	Green is lit when normal		
		NS	Green is lit: normal (DeviceNet online/connected)		
		SS	Green is lit when communicating with a sensor		

Section 3 How to Use Units

Step	Item	Description	
9	Communications Start	When remote I/O communications	Enable the scan list of the master side to change PLC to [Running] mode.
		When Explicit message communications	Send Explicit messages from the master side.

Wiring DeviceNet Communication Type

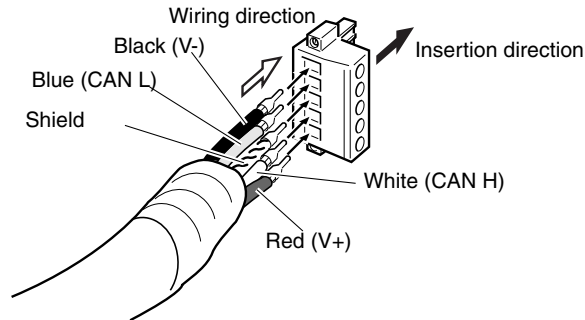

- Relationships between cable colors and signals are shown in the following table:

Color	Signal	Symbol
Black	Communication power supply, negative (-) side	V-
Blue	Signal, low side	CAN L
—	Shield	S
White	Signal, high side	CAN H
Red	Communication power supply, positive (+) side	V+



- Electricity power provided from the DeviceNet communication power supply are provided to the communication unit and all of the connected sensors. Select appropriate power supply by considering consumption electricity of the communication unit and sensors.
- Allowable current of the DeviceNet thin cable is 3 A, and that of the thick cable is 8 A. Make sure not to exceed these limits.
- For how to calculate electricity power as the DeviceNet system, refer to "DeviceNet User's Manual" (No. SCCC-308).

DeviceNet Remote I/O Communications

Allocating to Master

Data of E3X-DRT21-S is stored in the IN area of the DeviceNet master.

Select one of the following three modes using the DIP switch:

SW1	SW2	Operating Mode Settings	Number of Sensors that Can Be Connected
MODE0	MODE1		
OFF	OFF	Remote I/O communications 1CH mode	Max. 13
ON	OFF	Remote I/O communications 2CH mode	Max. 16
OFF	ON	Remote I/O communications 2CH + detection level monitor mode	Max. 16
ON	ON	Cannot be set	-

In addition, a connection type can be set by using the Configurator. The Communication Unit supports Bit-Strobe, Poll, COS, and Cyclic.



“DeviceNet Connection Settings” on p. 88

■ Remote I/O Communications 1CH Mode (SW1=OFF, SW2=OFF)

Up to 13 sensors can be connected. The IN area occupies 1CH of the master. Unit numbers of sensors are automatically assigned to the units from unit number 1 starting from the communication unit side (left).

Bit	Description
00	Unit No. 1 ON/OFF output data
01	Unit No. 2 ON/OFF output data
02	Unit No. 3 ON/OFF output data
03	Unit No. 4 ON/OFF output data
04	Unit No. 5 ON/OFF output data
05	Unit No. 6 ON/OFF output data
06	Unit No. 7 ON/OFF output data
07	Unit No. 8 ON/OFF output data

Bit	Description
08	Unit No. 9 ON/OFF output data
09	Unit No. 10 ON/OFF output data
10	Unit No. 11 ON/OFF output data
11	Unit No. 12 ON/OFF output data
12	Unit No. 13 ON/OFF output data
13	Communicating with the Mobile Console
14	Sensor communications error
15	Communicating with Sensor

- Communicating with Sensor:

When the communication with a sensor is established, it is turned ON.

- Sensor communications error:

When the registered number of connected sensors doesn't match the number of sensors that can be communicated, or when communications with a sensor fail after the connection with the sensor is established, it is turned ON.

- Communicating with the Mobile Console:

When the connection with the Mobile Console is established, it is turned ON.

Once the Mobile Console is connected, either Explicit message communications or setting/monitoring operations from the Configurator cannot be performed.

■ Remote I/O Communications 2CH Mode (SW1=ON, SW2=OFF)

Up to 16 sensors can be connected. The IN area occupies 2CH of the master.

mCH

Bit	Description
00	Unit No. 1 ON/OFF output data
01	Unit No. 2 ON/OFF output data
02	Unit No. 3 ON/OFF output data
03	Unit No. 4 ON/OFF output data
04	Unit No. 5 ON/OFF output data
05	Unit No. 6 ON/OFF output data
06	Unit No. 7 ON/OFF output data
07	Unit No. 8 ON/OFF output data

Bit	Description
08	Unit No. 9 ON/OFF output data
09	Unit No. 10 ON/OFF output data
10	Unit No. 11 ON/OFF output data
11	Unit No. 12 ON/OFF output data
12	Unit No. 13 ON/OFF output data
13	Unit No. 14 ON/OFF output data
14	Unit No. 15 ON/OFF output data
15	Unit No. 16 ON/OFF output data

m + 1CH

Bit	Description
00	Number of connected sensors (2 ⁰)
01	Number of connected sensors (2 ¹)
02	Number of connected sensors (2 ²)
03	Number of connected sensors (2 ³)
04	Number of connected sensors (2 ⁴)
05	Always 0
06	Always 0
07	Always 0

Bit	Description
08	Number of sensors that can be communicated with (2 ⁰)
09	Number of sensors that can be communicated with (2 ¹)
10	Number of sensors that can be communicated with (2 ²)
11	Number of sensors that can be communicated with (2 ³)
12	Number of sensors that can be communicated with (2 ⁴)
13	Communicating with the Mobile Console
14	Sensor communications error
15	Communicating with Sensor

- **Number of connected sensors:**
The number of currently registered sensors is shown in a range from 1 to 10 in hexadecimal (between 1 and 16 in decimal).
- **Number of sensors that can be communicated with:**
The number of current sensors that can be communicated with is shown in a range from 0 to 10 in hexadecimal (between 0 and 16 in decimal).
When failure occurs, you can confirm how many sensors are communicating normally.
- **Sensor communications error:**
When the registered number of connected sensors doesn't match the number of sensors that can be communicated, or when communications with a sensor fail after the connection with the sensor is established, it is turned ON.
- **Communicating with a sensor:** When the communication with a sensor is established, it is turned ON.

- Communicating with the Mobile Console:

When the connection with the Mobile Console is established, it is turned ON.

Once the Mobile Console is connected, either Explicit message communications or setting/monitoring operations from the Configurator cannot be performed.



For Sensors that occupy two units, two bits of ON/OFF output data are occupied. In addition, one sensor occupies two units.

■ Remote I/O Communications 2CH + Detection level Monitor Mode (SW1=OFF, SW2=ON)

Up to 16 sensors can be connected.

The detection level monitor watches connected sensors. The IN area occupies (the number of units to be monitored + 2) CH of the master.

mCH

Bit	Description
00	Unit No. 1 ON/OFF output data
01	Unit No. 2 ON/OFF output data
02	Unit No. 3 ON/OFF output data
03	Unit No. 4 ON/OFF output data
04	Unit No. 5 ON/OFF output data
05	Unit No. 6 ON/OFF output data
06	Unit No. 7 ON/OFF output data
07	Unit No. 8 ON/OFF output data

Bit	Description
08	Unit No. 9 ON/OFF output data
09	Unit No. 10 ON/OFF output data
10	Unit No. 11 ON/OFF output data
11	Unit No. 12 ON/OFF output data
12	Unit No. 13 ON/OFF output data
13	Unit No. 14 ON/OFF output data
14	Unit No. 15 ON/OFF output data
15	Unit No. 16 ON/OFF output data

m + 1CH

Bit	Description
00	Number of connected sensors (2 ⁰)
01	Number of connected sensors (2 ¹)
02	Number of connected sensors (2 ²)
03	Number of connected sensors (2 ³)
04	Number of connected sensors (2 ⁴)
05	Always 0
06	Always 0
07	Always 0

Bit	Description
08	Number of sensors that can be communicated with (2 ⁰)
09	Number of sensors that can be communicated with (2 ¹)
10	Number of sensors that can be communicated with (2 ²)
11	Number of sensors that can be communicated with (2 ³)
12	Number of sensors that can be communicated with (2 ⁴)
13	Communicating with the Mobile Console
14	Sensor communications error
15	Communicating with Sensor

	15	14	13	12	11	10	09	08	07	06	05	04	03	02	01	00
m + 2CH	Unit No. 1 Detection level															
m + 3CH	Unit No. 2 Detection level															
m + 4CH	Unit No. 3 Detection level															
:	:															
:	:															
m + nCH	Unit No. n - 1 Detection level															
m + n + 1CH	Unit No. n Detection level															

Number of units to be monitored for digital values: n



- If the number of units to be monitored for the detection level is bigger than the number of sensors to be communicated with, the detection level of unconnected sensors are [0000].
- When the Mobile Console is connected, data is [7FFF], because the detection level cannot be retrieved.
- When communications with a sensor fail, the detection level of the sensor are [7FFF].
- The ON/OFF output of the sensor and update timing of the detection level are not synchronized. Note that, even if you confirm ON/OFF state to retrieve the detection level, they are not the detection level upon ON/OFF. Set the display settings to peak on detected and bottom on undetected to retrieve the detection level upon ON/OFF.

Explicit Message Communications

Sending a DeviceNet Explicit message from the master to the Communication Unit enables reading and writing any parameters of the specified sensor. The Communication Unit processes the command sent from the master and then returns a response.

Basic Format of Explicit Messages

The basic format of each command and response is shown below:

● Command Format

Destination Node Address	Service Code	Class ID	Instance ID	Attribute ID	Data
--------------------------	--------------	----------	-------------	--------------	------

[Destination Node Address]

Specify a node address of the unit that an Explicit message (command) is sent to. The node address must be a single byte in hexadecimal.

[ServiceCode], [Class ID], [Instance ID], [Attribute ID]

These are parameters to specify a command type, process target, and process details.

The Communication Unit uses the [Instance ID] to specify to sensors for which the command is intended (Sensor unit number.) Some commands do not require an [Attribute ID].



Depending on the master, each length of [Class ID], [Instance ID], and [Attribute ID] might be different. When a message is sent from an Omron DeviceNet master, specify a [Class ID] and an [Instance ID] in two bytes as four digits, and an [Attribute ID] in a single byte as two digits.

[Data]: Data is not required when using a Read command.

● Response Format

• Normal

Number of Received Bytes	Source Node Address	Service Code	Data
--------------------------	---------------------	--------------	------

• Failure

Number of Received Bytes: 0004Hex (Fixed)	Source Node Address	Service Code	Error Code
---	---------------------	--------------	------------

[Number of Received Bytes]

The number of the received data starting from the [Source Node Address] is returned in hexadecimal. When an error response is returned to the Explicit message, the value always will be 0004Hex.

[Source Node Address]

The node address of the node that sent the command is returned in hexadecimal.

[ServiceCode]

When the command is completed normally, the leftmost bit of the [ServiceCode] specified in the command is turned ON and stored as follows:

ServiceCode of the Command	ServiceCode of the Response
10 Hex	90 Hex
0E Hex	8E Hex
16 Hex	96 Hex
06 Hex	86 Hex
07 Hex	87 Hex
05 Hex	85 Hex

When an error message is returned to the Explicit message, the value always will be 94Hex.

[Data]: The read data is stored only when a read command has been sent.

[Error Code]: An error code for the Explicit message.

 "Error Code List" on p. 72



CHECK!

- For the Communication Unit, set the DeviceNet message monitoring timer to 20 seconds or more. The setting method is as follows:

(1) For CS1W-DRM21 and CJ1W-DRM21

You can set the following by using the Configurator:

1. Switch the Configurator to online.(select [Network] - [Connection])
2. Select either CS1W-DRM21 or CJ1W-DRM21, and then double-click it.
3. Set the monitoring timer for the node of the communication unit to 20,000 ms.

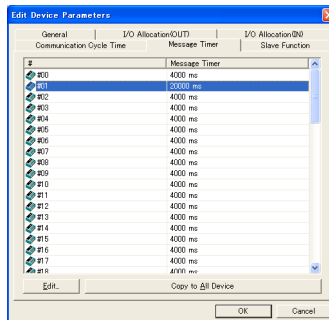

4. Set the response monitoring timer in [CMND] commands, which sends Explicit messages, to 20,000 ms or more.

(2) For C200HW-DRM21 and CVM1-DRM21

1. Set the response monitoring timer in [IOWR] commands, which send Explicit messages, to 20,000 ms.

(The message monitoring timer does not need to be set with the Configurator.)

Read Commands

A Read command reads data of a connected sensor or communication unit.
 When using an OMRON master, command/response formats are shown as follows:

● Command Format

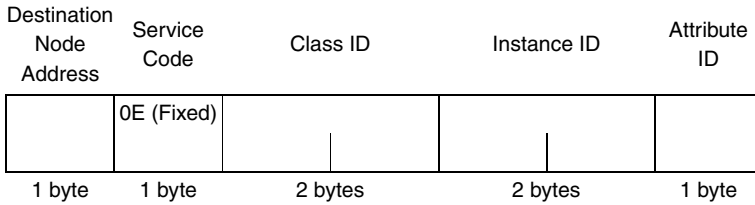

● Response Format

• Normal

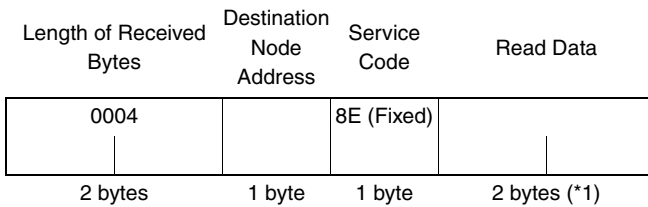

• Error

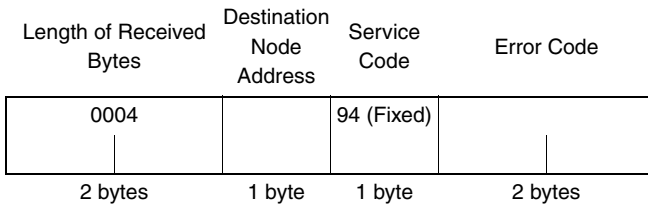

■ Read Command List

A list of Explicit Message Read commands is shown below.

[Supported Models]

E3X-DA7-S, E3X-DA9-S: DA7, E3X-DA-S: DA, E3X-MDA: MDA, E3X-DATW-S: TW, E3X-DARM-S: RM; E3X

E3C-LDA (2 output types): LDATW, E3C-LDA (input type): LDARM; E3C

E2C-EDA (2 output types): EDATW, E2C-EDA (input type): EDARM; E2C

Explicit Messages	Functions	Command			Supported Model
		Class ID	Instance ID	Attribute ID	
Read status	Reads the status of the sensor communication unit.	9F	0	AA	—
Read detection level	With specifying a Unit No. with the Instance ID, reads the digital detection level.	9F	Unit Number	82	All models
Read detection level + ON/OFF output data	With specifying a Unit No. with the Instance ID, reads the detection level and ON/OFF output.	9F	Unit Number	81	All models
When detected (ON) Read detection level	With specifying a Unit No. with the Instance ID, reads the detection level when detected (ON).	9F	Unit Number	96	All models
When detected (ON) Read detection level	With specifying a Unit No. with the Instance ID, reads the detection level when not detected (OFF).	9F	Unit Number	97	All models
Read Threshold Settings	With specifying a Unit No. with the Instance ID, reads the threshold value.	9C	Unit Number	11	All models
Read Differentiation Threshold Settings	With specifying a Unit No. with the Instance ID, reads the differentiation mode threshold.	9C	Unit Number	10	Except DA, and MDA
Read Difference Threshold Settings	With specifying a Unit No. with the Instance ID, reads the threshold value when the difference outputs.	9C	Unit Number	12	MDA
Read Operating Mode Settings	With specifying a Unit No. with the Instance ID, reads the operating mode.	9C	Unit Number	20	DA7, TW, MDA, LDATW, EDATW
Read Detection Function Settings	With specifying a Unit No. with the Instance ID, reads the detection mode.	9C	Unit Number	21	All models
Read Differentiation Edge Settings	With specifying a Unit No. with the Instance ID, reads the differentiation edge.	9C	Unit Number	22	Except DA, and MDA
Differentiation mode Read Response Time	With specifying a Unit No. with the Instance ID, reads the differentiation mode response time.	9C	Unit Number	23	Except DA, and MDA
Read Timer Function Settings	With specifying a Unit No. with the Instance ID, reads the timer function.	9C	Unit Number	24	All models
Read Timer Time Settings	With specifying a Unit No. with the Instance ID, reads the timer time.	9C	Unit Number	25	All models

Section 3 Explicit Message Communications

Explicit Messages	Functions	Command			Supported Model
		Class ID	Instance ID	Attribute ID	
ON-Delay and OFF-Delay timerRead ON-Delay timer time Settings	With specifying a Unit No. with the Instance ID, reads the ON-Delay timer time.	9C	Unit Number	E6	DA7
ON-Delay and OFF-Delay timerRead OFF-Delay timer time Settings	With specifying a Unit No. with the Instance ID, reads the OFF-Delay timer time.	9C	Unit Number	E7	DA7
Read Display Switching Settings	With specifying a Unit No. with the Instance ID, reads the display switching settings.	9C	Unit Number	26	All models
Read MODE Key Settings	With specifying a Unit No. with the Instance ID, reads the MODE key settings.	9C	Unit Number	27	All models
Read Display Direction Settings	With specifying a Unit No. with the Instance ID, reads the display direction settings.	9C	Unit Number	28	All models
Read Power Tuning Target Value Settings	With specifying a unit No. with the Instance ID, reads the power tuning target value.	9C	Unit Number	29	Except EDATW and EDARM
Read Output Settings	With specifying a Unit No. with the Instance ID, reads the output settings.	9C	Unit Number	2A	DA7, TW, MDA, LDATW, EDATW
Read Output Settings Timer Function	With specifying a Unit No. with the Instance ID, reads the output settings timer function.	9C	Unit Number	2B	MDA
Read Output Settings Timer Time	With specifying a Unit No. with the Instance ID, reads the output settings timer time.	9C	Unit Number	2D	MDA
Read External Input Settings	With specifying a Unit No. with the Instance ID, reads the input settings.	9C	Unit Number	2C	RM, LDARM, EDARM
Read External Input Memory Settings	With specifying a Unit No. with the Instance ID, reads the external input memory settings.	9C	Unit Number	2E	RM, LDARM, EDARM
Read Teaching Level Settings without a Workpiece	With specifying a Unit No. with the Instance ID, reads the teaching level settings without a workpiece.	9C	Unit Number	4B	All models
Read Counter Settings	With specifying a Unit No. with the Instance ID, reads the counter settings.	9C	Unit Number	2F	RM, LDARM
Read Counter Value (Upper) Settings	With specifying a Unit No. with the Instance ID, reads the counter value (upper) settings.	9C	Unit Number	30	RM, LDARM
Read the Counter Value (Lower) Settings	With specifying a Unit No. with the Instance ID, reads the counter value (lower) settings.	9C	Unit Number	31	RM, LDARM
Read Counter Value (Upper)	With specifying a Unit No. with the Instance ID, reads the count value (upper four digits).	9F	Unit Number	84	RM, LDARM
Read Count Value (Lower)	With specifying a Unit No. with the Instance ID, reads the count value (lower four digits).	9F	Unit Number	85	RM, LDARM

Explicit Messages	Functions	Command			Supported Model
		Class ID	Instance ID	Attribute ID	
Read Power Tuning Threshold Settings	With specifying a Unit No. with the Instance ID, reads the power tuning threshold settings.	9C	Unit Number	40	Except EDATW and EDARM
Read ATC Function at Power Supply ON Settings	With specifying a Unit No. with the Instance ID, reads ATC function at power supply ON settings.	9C	Unit Number	42	DA7
Read ATC Function Settings	With specifying a Unit No. with the Instance ID, reads ATC function settings.	9C	Unit Number	44	DA7
Read "Eco" Mode Settings	With specifying a Unit No. with the Instance ID, reads the "Eco" mode settings.	9C	Unit Number	45	All models
Read Zero Reset Level	With specifying a Unit No. with the Instance ID, reads the zero reset level.	9C	Unit Number	48	All models
Read Threshold Ratio Settings	With specifying a Unit No. with the Instance ID, reads threshold ratio settings.	9C	Unit Number	4E	DA7
Read the number of mutual interference prevention units	With specifying a Unit No. with the Instance ID, reads the number of mutual interference.	9C	Unit Number	4D	EDATW, EDARM
Read Key Lock Settings	With specifying a Unit No. with the Instance ID, reads the key lock settings.	9C	Unit Number	50	All models
Read Number of Connected Sensors	Reads the number of connected sensors.	9C	0	57	—

A range of unit Nos. in the Instance ID should be between 0001Hex and 0010Hex.

Data format of each item is shown below:

● **Read Status**

Bit	Description
00	Number of connected sensors (2 ⁰)
01	Number of connected sensors (2 ¹)
02	Number of connected sensors (2 ²)
03	Number of connected sensors (2 ³)
04	Number of connected sensors (2 ⁴)
05	Always 0
06	Always 0
07	Always 0

Bit	Description
08	Number of sensors that can be communicated with (2 ⁰)
09	Number of sensors that can be communicated with (2 ¹)
10	Number of sensors that can be communicated with (2 ²)
11	Number of sensors that can be communicated with (2 ³)
12	Number of sensors that can be communicated with (2 ⁴)
13	Always 0
14	Sensor communications error
15	Communicating with Sensor

- Number of connected sensors:

The number of current connected sensors that are already registered is shown in hexadecimal.

- **Number of sensors that can be communicated with:**
The number of current sensors that can be communicated with is shown in hexadecimal. When failure occurs, you can confirm how many sensors are communicating successfully.
- **Communicating with Sensor:**
When the communication with a sensor is established, it is turned ON.
- **Sensor communications error:**
When the registered number of connected sensors doesn't match the number of sensors that can be communicated, or when communications with a sensor fail after the connection with the sensor is established, it is turned ON.

● **Read the detection level/read the detection level on detected (ON)/ read the detection level on undetected (OFF)**

These commands read the detection level of the sensor with the unit No. specified with the Instance ID.

Those data is shown in hexadecimal as a four-digit value (two bytes).

If the data is negative, the 12th bit is 1 (on).

Detection level				Bit 15	Bit 14	Bit 13	Bit 12	Bit 11	Bit 10	Bit 09	Bit 08	Bit 07	Bit 06	Bit 05	Bit 04	Bit 03	Bit 02	Bit 01	Bit 00
0 Fixed							0: + / 1: -	The detection level (000Hex to FA0Hex)											

Read Detection level on Detected (ON) and Read Detection level on Undetected (OFF) can read the detection level only when the display switching settings are peak on detected and bottom on undetected.

Also, its data range is between F831Hex (complement of 2) and 0FA0Hex.

● **Read detection level + ON/OFF output**

It reads the detection level of the sensor with the unit No. specified with the Instance ID.

The data is shown in hexadecimal as a four-digit value (two bytes).

If the data is negative, the 12th bit is 1 (on).

Detection level + ON/ OFF output				Bit 15	Bit 14	Bit 13	Bit 12	Bit 11	Bit 10	Bit 09	Bit 08	Bit 07	Bit 06	Bit 05	Bit 04	Bit 03	Bit 02	Bit 01	Bit 00
*1	*2	0 Fixed	0: + / 1: -	The detection level (000Hex to FA0Hex)															

Bit	Description	Data
Bit 14 (*2)	External input data	0: No external input, 1: External input
Bit 15 (*1)	ON/OFF output data	0: OFF, 1: ON

● **Read threshold settings/read threshold settings on differentiation mode/read threshold settings on difference outputs**

These commands read threshold settings of the sensor with the unit No. specified with the Instance ID. Data is shown in hexadecimal, and the data for each single unit is 16-bits long. If the data is negative, the 12th bit is 1 (on).

Threshold settings															
Bit 15	Bit 14	Bit 13	Bit 12	Bit 11	Bit 10	Bit 09	Bit 08	Bit 07	Bit 06	Bit 05	Bit 04	Bit 03	Bit 02	Bit 01	Bit 00
0 Fixed			0: + / 1: -	Threshold setting (0000Hex to 0FA0Hex)											

Depending on the sensor type, [Read Differentiation Threshold Settings] and [Read Difference Threshold Settings] might not be able to be performed correctly.

● **Read Operating Mode Settings**

It reads the operating mode settings of the sensor with the unit No. specified with the Instance ID.

Bit	Description	Data
00	Operating mode	E3X, E3C: 0: L/ON, 1: D/ON; E2C: 0: NO, 1: NC
01 to 15	No data	Always 0

● **Read Detection Function Settings**

It reads the operating mode settings of the sensor with the unit No. specified with the Instance ID.

Bit	Description	Data
00	Detection mode	0: STAND, 1: HI-RESO, 2: Differentiation, 4: High speed, 6: Tough(DA7)
01		
02		
03 to 15	No data	Always 0

Note that some models cannot be set to the high speed mode.

● **Read Differentiation Edge Settings**

It reads the differentiation edge settings of the sensor with the unit No. specified with the Instance ID.

Bit	Description	Data
00	Operating mode	0: Single-end edge, 1: Double-end edge
01 to 15	No data	Always 0

● **Read Differentiation Response Speed Settings**

It reads the differentiation response speed settings of the sensor with the unit No. specified with the Instance ID.

Bit	Description	Data
00	Differentiation response time	1: Differentiation response speed setting 1 2: Differentiation response speed setting 2 3: Differentiation response speed setting 3 4: Differentiation response speed setting 4 5: Differentiation response speed setting 5
01		
02		
03		
04 to 15	No data	Always 0

● **Read Timer Function Settings**

It reads the timer function settings of the sensor with the unit No. specified with the Instance ID.

Bit	Description	Data
00	Timer function	0: Timer function disabled 1: OFF-delay timer 2: ON-delay timer 3: One-shot timer 4: ON-delay and OFF-delay timer
01		
02 to 15	No data	Always 0

● **Read Timer Time Settings/Read ON-Delay timer time Settings/Read OFF-Delay timer time Settings**

It reads the timer time settings of the sensor with the unit No. specified with the Instance ID.

Its read data is expressed in hexadecimal and its length is two bytes; the data range is between 0000hex (0) and 1388hex (5000).

When the timer function setting is OFF, [Read Timer Time Settings] command fails if the command is sent.

● **Read Display Switching**

It reads the display switching settings of the sensor with the unit No. specified with the Instance ID.

Bit	Description	Data
00	Display switching setting	0: Detection level and detection level (MDA)
01		1: Detection level and threshold
02		2: Detection level ratio and threshold
03		3: Peak on detected and bottom on undetected
		4: Detection level at peak and detection level at bottom (time update) (E3X, E3C are bottom on detected and peak on undetected)
		5: Analog bar
		6: Detection level and peak digital values
		7: Detection level and channel number
		8: Count value (RM, LDARM)
04 to 15	No data	Always 0

● **Read MODE Key Settings**

It reads the MODE key settings of the sensor with the unit No. specified with the Instance ID.

Bit	Description	Data
00	MODE key setting	0: E3X, E3C: Power tuning, E2C: Fine positioning
01		1: Zero reset
02		2: Counter reset (RM, LDARM)
		3: Position teaching (E2C)
		4: Teaching with the workpiece or without a workpiece
03 to 15	No data	Always 0

● **Read Display Direction Settings**

It reads the MODE key settings of the sensor with the unit No. specified with the Instance ID.

Bit	Description	Data
00	Display direction setting	0: Normal, 1: Vertical reverse
04 to 15	No data	Always 0

● **Read Power Tuning Target Value Settings**

It reads the power tuning target value settings of the sensor with the unit No. specified with the Instance ID. Its read data is expressed in hexadecimal and its length is two bytes; the data range is between 0064hex (100) and 0F3Chex (4000).

● **Read Output Settings**

It reads the output settings of the sensor with the unit No. specified with the Instance ID.

Bit	Description	Data
00	Output settings	0: Output for each channel
01		1: Area output (TW, LDATW, EDATW)
02		2: Self diagnosis output (TW, LDATW, EDATW)
03		3: AND output (MDA)
		4: OR output (MDA)
		5: Difference output (MDA)
		6: Rising edge sync output (MDA)
		7: Down edge sync output (MDA)
		8: Head error output (E2C)
04 to 15	No data	Always 0

● **Read Output Setting Timer Function Settings**

It reads the output setting timer function settings of the sensor with the unit No. specified with the Instance ID.

Bit	Description	Data
00	Output setting timer function	0: Timer function disabled
01		1: OFF-delay timer
		2: ON-delay timer
		3: One-shot timer
02 to 15	No data	Always 0

● **Read Output Setting Timer Time Settings**

It reads the output timer time settings of the sensor with the unit No. specified with the Instance ID.

Its read data is expressed in hexadecimal and its length is two bytes; the data range is between 0000hex (0) and 1388hex (5000).

When the output setting timer function setting is OFF, [Output Setting Timer Time Settings] command fails if the command is sent.

● **Read External Input Settings**

It reads the output timer time settings of the sensor with the unit No. specified with the Instance ID.

Bit	Description	Data
00	Input setting	0: Teaching without a through-beam type workpiece
01		1: Teaching without a reflective type workpiece
02		2: Teaching with the workpiece or without a workpiece
03		3: Auto teaching
		4: Power tuning (E3X,E3C) or fine positioning (E2C)
		5: Zero reset
		6: Projection lighting off (E3X, E3C)
		7: Counter reset (RM, LDARM)
		8: Sync detection input (E2C)
		9: Position teaching
04 to 15	No data	Always 0

● **Read External Input Memory Settings**

It reads the external input memory settings of the sensor with the unit No. specified with the Instance ID.

Bit	Description	Data
00	External input memory settings	0: OFF (unwritten), 1: ON (write)
01 to 15	No data	Always 0

● **Read Teaching Level Settings without a Workpiece**

It reads the teaching level settings without a workpiece of the sensor with the unit No. specified with the Instance ID.

Its read data is expressed in hexadecimal and its length is two bytes; the data range is between 00hex (0) and 63hex (99).

● **Read Counter Settings**

It reads the counter settings of the sensor with the unit No. specified with the Instance ID.

Bit	Description	Data
00	Counter settings	0: Counter function disabled
01		1: Incremental counting 2: Decremental counting
02 to 15	No data	Always 0

● **Read Counter Value (Upper/Lower) Settings**

It reads the counter settings (Upper/Lower) of the sensor with the unit No. specified with the Instance ID.

Counter value setting (upper 16 bits) (0000Hex to 05F5Hex)	Counter value setting (lower 16 bits) (0000Hex to FFFFHex)
---	---

When the counter function setting is OFF, [Read Counter Value (Upper) Settings] and [Read Counter Value (Lower) Settings] commands fail if either of the commands is sent.

● **Read Count Value (Upper/Lower)**

It reads the counter value (upper/lower) settings of the sensor with the unit No. specified with the Instance ID.

Count value (upper 16 bits) (0000Hex to 05F5Hex)	Count value (lower 16 bits) (0000Hex to FFFFHex)
--	--

● **Read Power Tuning (Fine Positioning) Settings**

It reads the power tuning (fine positioning) settings of the sensor with the unit No. specified with the Instance ID.

Bit	Description	Data
00	Power tuning (fine positioning) setting	0: OFF (inactive), 1: ON (active)
01 to 15	No data	Always 0

● **Read Power Tuning Threshold Settings**

It reads the power tuning threshold settings of the sensor with the unit No. specified with the Instance ID. Its read data is expressed in hexadecimal and its length is two bytes; the data range is between 0000hex (0) and 0FA0hex (4000).

● **Read ATC Function at Power Supply ON Settings**

It reads the ATC Function at Power Supply ON settings of the sensor with the unit No. specified with the Instance ID.

Bit	Description	Data
00	ATC Function at Power Supply ON settings	0: OFF, 1: ATC-Start,
01		2: Power tuning and ATC-Start
02 to 15	No data	Always 0

● **Read ATC Function Settings**

It reads the ATC Function settings of the sensor with the unit No. specified with the Instance ID.

Bit	Description	Data
00	ATC Function at Power Supply ON settings	0: OFF, 1: ATC-Start, 2: Power tuning and ATC-Start
01		
02 to 15	No data	Always 0

● **Read Eco Mode Settings**

It reads the Eco mode settings of the sensor with the unit No. specified with the Instance ID.

Bit	Description	Data
00	ATC settings	0: OFF, 1:ON
01 to 15	No data	Always 0

● **Read Zero Reset Level**

It reads the zero reset level of the sensor with the unit No. specified with the Instance ID. Its read data is expressed in hexadecimal and its length is two bytes; the data range is between 0000hex (0) and 0FA0hex (4000).

● **Read Threshold Ratio Settings**

It reads the threshold ratio settings of the sensor with the unit No. specified with the Instance ID.

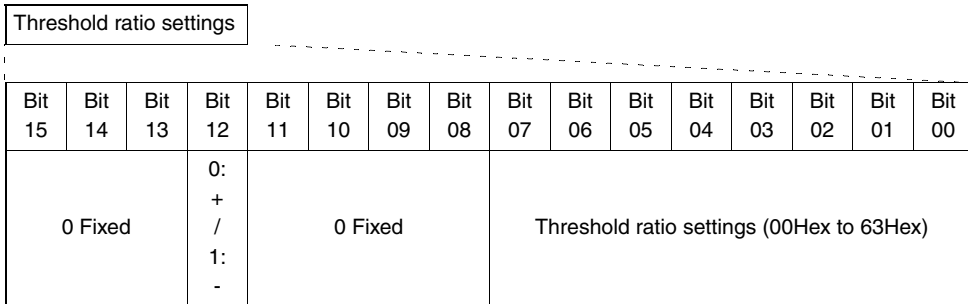

● **Read Setting Number of Units for Mutual Interference Prevention**

It reads the setting number of units for mutual interference prevention of the sensor with the unit No. specified with the Instance ID.

Bit	Description	Data
00	Setting number of mutual interference prevention	0: OFF
01		1: 1 unit, 2: 2 units, 3: 3 units, 4: 4 units, 5: 5 units
02		
03 to 15	No data	Always 0

● **Read Number of Connected Sensors**

It reads the number of connected sensors in hexadecimal as a four-digit number and its data length is two bytes.

The data range is between 0001Hex and 0010Hex.

● **Read Number of Units to Monitor The detection level**

When 2CH + the detection level monitor mode (DIP switches: SW1=OFF, SW2=OFF) is set, it reads the number of units that the detection level are monitored; the number is expressed in hexadecimal and two-bytes long as four digits.

The data range is between 0000Hex and 0010Hex.

Write Commands

A write command writes its data to a connected sensor or communication unit.
 When using an OMRON master, command/response formats are shown as follows:

● Command Format

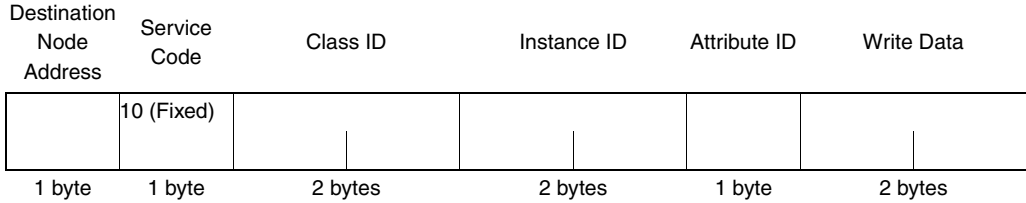

● Response Format

• Normal

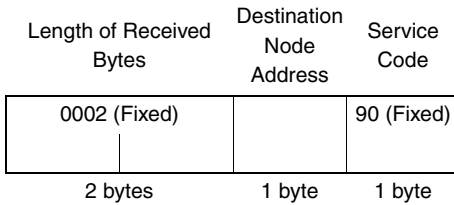

• Error

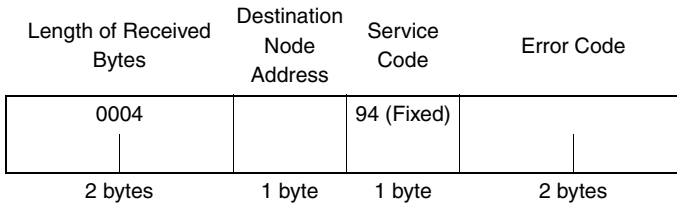

■ Write Command List

A list of Explicit Message Write commands is shown below.

[Supported Models]

E3X-DA7-S, E3X-DA9-S: DA7, E3X-DA-S: DA, E3X-MDA: MDA, E3X-DATW-S: TW,
E3X-DARM-S: RM; E3X

E3C-LDA (2 output types): LDATW, E3C-LDA (input type): LDARM; E3C

E2C-EDA (2 output types): EDATW, E2C-EDA (input type): EDARM; E2C

Explicit Messages	Functions	Command			Supported Model
		Class ID	Instance ID	Attribute ID	
Write Threshold Settings	With specifying a Unit No. with the Instance ID, writes the threshold value.	9C	Unit Number	11	All models
Write Differentiation Threshold Value Settings	With specifying a Unit No. with the Instance ID, writes the differentiation mode threshold.	9C	Unit Number	10	Except DA, and MDA
Write Difference Threshold Settings	With specifying a Unit No. with the Instance ID, writes the threshold value when the difference outputs.	9C	Unit Number	12	MDA
Write Operating Mode Settings	With specifying a Unit No. with the Instance ID, writes the operating mode.	9C	Unit Number	20	DA7, TW, MDA, LDATW, EDATW
Write Detection Mode Settings	With specifying a Unit No. with the Instance ID, writes the detection mode.	9C	Unit Number	21	All models
Write Differentiation Edge Settings	With specifying a Unit No. with the Instance ID, writes the differentiation edge.	9C	Unit Number	22	Except DA, and MDA
Write Differentiation Mode Response Time	With specifying a Unit No. with the Instance ID, writes the differentiation mode response time.	9C	Unit Number	23	Except DA, and MDA
Write Timer Function Settings	With specifying a Unit No. with the Instance ID, writes the timer function.	9C	Unit Number	24	All models
Write Timer Time Settings	With specifying a Unit No. with the Instance ID, writes the timer time.	9C	Unit Number	25	All models
ON-Delay and OFF-Delay timerWrite ON-Delay timer time Settings	With specifying a Unit No. with the Instance ID, writes the ON-Delay timer time.	9C	Unit Number	F6	DA7
ON-Delay and OFF-Delay timerWrite OFF-Delay timer time Settings	With specifying a Unit No. with the Instance ID, writes the OFF-Delay timer time.	9C	Unit Number	F7	DA7
Write Display Switching Settings	With specifying a Unit No. with the Instance ID, writes the display switching settings.	9C	Unit Number	26	All models
Write MODE Key Settings	With specifying a Unit No. with the Instance ID, writes the MODE key settings.	9C	Unit Number	27	All models

Section 3 Explicit Message Communications

Explicit Messages	Functions	Command			Supported Model
		Class ID	Instance ID	Attribute ID	
Write Display Direction Settings	With specifying a Unit No. with the Instance ID, writes the display direction settings.	9C	Unit Number	28	All models
Write Power Tuning Target Value Settings	With specifying a unit No. with the Instance ID, writes the power tuning target value.	9C	Unit Number	29	Except EDATW and EDARM
Write Output Settings	With specifying a Unit No. with the Instance ID, writes the output settings.	9C	Unit Number	2A	DA7, TW, MDA, LDATW, EDATW
Write Output Setting Timer Function	With specifying a Unit No. with the Instance ID, writes the output setting timer function.	9C	Unit Number	2B	MDA
Write Output Setting Timer Time	With specifying a Unit No. with the Instance ID, writes the output setting timer time.	9C	Unit Number	2D	MDA
Write External Input Settings	With specifying a Unit No. with the Instance ID, writes the input setting read.	9C	Unit Number	2C	RM, LDARM, EDARM
Write External Input Memory Settings	With specifying a Unit No. with the Instance ID, writes the external input memory settings.	9C	Unit Number	2E	RM, LDARM, EDARM
Write Teaching Level Settings without a Workpiece	With specifying a Unit No. with the Instance ID, writes the teaching level settings without a workpiece.	9C	Unit Number	4B	All models
Write Counter Settings	With specifying a Unit No. with the Instance ID, writes the counter settings.	9C	Unit Number	2F	RM, LDARM
Write Counter Value (Upper) Settings	With specifying a Unit No. with the Instance ID, writes the counter value (upper) settings.	9C	Unit Number	30	RM, LDARM
Write Counter Value (Lower) Settings	With specifying a Unit No. with the Instance ID, writes the counter value (lower) settings.	9C	Unit Number	31	RM, LDARM
Write Power Tuning Threshold Settings	With specifying a Unit No. with the Instance ID, writes the power tuning threshold settings.	9C	Unit Number	40	Except EDATW and EDARM
Write ATC Function at Power Supply ON Settings	With specifying a Unit No. with the Instance ID, writes ATC function at power supply ON settings.	9C	Unit Number	42	DA7
Write ATC Function Settings	With specifying a Unit No. with the Instance ID, writes ATC function settings.	9C	Unit Number	44	DA7
Write Threshold Ratio Settings	With specifying a Unit No. with the Instance ID, writes threshold ratio settings.	9C	Unit Number	4E	DA7

Explicit Messages	Functions	Command			Supported Model
		Class ID	Instance ID	Attribute ID	
Write Eco Mode Settings	With specifying a Unit No. with the Instance ID, writes the "Eco" mode settings.	9C	Unit Number	45	All models
Write Number of Mutual Interference Prevention Units	With specifying a Unit No. with the Instance ID, writes the number of mutual interference prevention units.	9C	Unit Number	4D	EDATW, EDARM

A range of unit Nos. in the Instance ID should be between 0001Hex and 0010Hex.



CHECK!

When a write command is executed, the setting values are written into the internal memory. How many times the internal memory can be written is limited; if writing data in the memory one million times or more per sensor per parameter is attempted, the internal memory might be destroyed. When a write command is used, therefore, make sure to create a communication program that writing times don't exceed one million times per sensor per parameter.

● **Write Threshold Settings/Write Differentiation Threshold Settings/Write Difference Threshold Settings**

It writes threshold settings of the sensor with the unit No. specified with the Instance ID. Data is shown in hexadecimal, and the data for each single unit is 16-bits long. If the data is negative, the 12th bit is 1 (on).

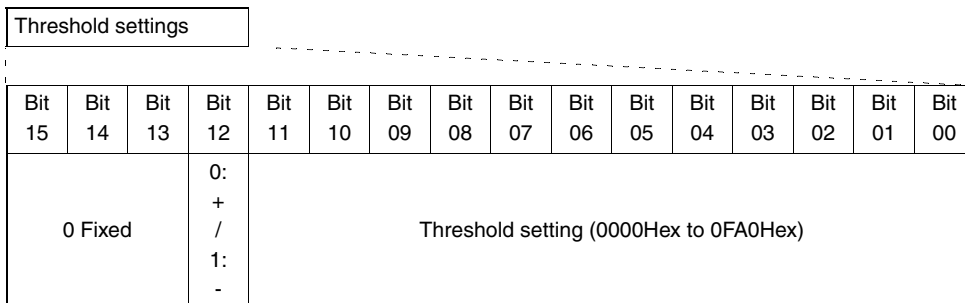

Depending on a sensor type, [Write Differentiation Threshold Settings] and [Write Difference Threshold Settings] might not be able to be performed correctly.

● **Write Operating Mode Settings**

It writes the operating mode settings of the sensor with the unit No. specified with the Instance ID.

Bit	Description	Data
00	Operating mode	E3X, E3C: 0: L/ON, 1: D/ON E2C: 0: NO, 1:NC
01 to 15	No data	Always 0

● **Write Detection Mode Settings**

It writes the operating mode settings of the sensor with the unit No. specified with the Instance ID.

Bit	Description	Data
00	Detection mode	0: STAND, 1: HI-RESO, 2: Differentiation, 4: High speed, 6: Tough(DA7)
01		
02		
03 to 15	No data	Always 0

Note that some models do not support high speed writing.

● **Write Differentiation Edge Settings**

It writes the differentiation edge settings of the sensor with the unit No. specified with the Instance ID.

Bit	Description	Data
00	Operating mode	0: Single-end edge, 1: Double-end edge
01 to 15	No data	Always 0

● Write Differentiation Response Speed Settings

It writes the differentiation response time settings of the sensor with the unit No. specified with the Instance ID.

Bit	Description	Data
00	Differentiation response time	1: Differentiation response speed setting 1
01		2: Differentiation response speed setting 2
02		3: Differentiation response speed setting 3
03		4: Differentiation response speed setting 4
04 to 15	No data	Always 0

● Write Timer Function Settings

It writes the timer function settings of the sensor with the unit No. specified with the Instance ID.

Bit	Description	Data
00	Timer function	0: Timer function disabled
01		1: OFF-delay timer 2: ON-delay timer 3: One-shot timer 4: ON-delay and OFF-delay timer
02 to 15	No data	Always 0

● Write Timer Time Settings/Write ON-Delay timer time Settings/Write OFF-Delay timer time Settings

It writes the timer time settings of the sensor with the unit No. specified with the Instance ID.

Its write data is expressed in hexadecimal and its length is two bytes; the data range is between 0000hex (0) and 1388hex (5000).

When the timer function setting is OFF, [Write Timer Time Settings] command fails if the command is sent.

● Write Display Switching

It writes the display switching settings of the sensor with the unit No. specified with the Instance ID.

Bit	Description	Data
00	Display switching setting	0: Detection level and detection level (MDA)
01		1: Detection level and threshold
02		2: Detection level ratio and threshold
03		3: Peak on detected and bottom on undetected
		4: Detection level at peak and detection level at bottom (time update) (E3X, E3C are bottom on detected and peak on undetected)
		5: Analog bar
		6: Detection level and peak digital values
		7: Detection level and channel number
		8: Count value (RM, LDARM)
04 to 15	No data	Always 0

● **Write MODE Key Settings**

It writes the MODE key settings of the sensor with the unit No. specified with the Instance ID.

Bit	Description	Data
00	MODE key setting	0: E3X, E3C: Power tuning E2C: Fine positioning 1: Zero reset 2: Counter reset (RM, LDARM) 3: Position teaching (E2C) 4: Teaching with the workpiece or without a workpiece
01		
02		
03 to 15	No data	Always 0

● **Write Display Direction Settings**

It writes the MODE key settings of the sensor with the unit No. specified with the Instance ID.

Bit	Description	Data
00	Display direction setting	0: Normal, 1: Vertical reverse
04 to 15	No data	Always 0

● **Write Power Tuning Target Value Settings**

It writes the power tuning target value settings of the sensor with the unit No. specified with the Instance ID. Its write data is expressed in hexadecimal and its length is two bytes; the data range is between 0064hex (100) and 0F3Chex (4000).

● **Write Output Settings**

It writes the output settings of the sensor with the unit No. specified with the Instance ID.

Bit	Description	Data
00	Output settings	0: Output for each channel 1: Area output (TW, LDATW, EDATW) 2: Self diagnosis output (TW, LDATW, EDATW) 3: AND output (MDA) 4: OR output (MDA) 5: Difference output (MDA) 6: Rising edge sync output (MDA) 7: Down edge sync output (MDA) 8: Head error output (E2C)
01		
02		
03		
04 to 15	No data	Always 0

● Write Output Setting Timer Function Settings

It writes the output timer function settings of the sensor with the unit No. specified with the Instance ID.

Bit	Description	Data
00	Output setting timer function	0: Timer function disabled
01		1: OFF-delay timer 2: ON-delay timer 3: One-shot timer
02 to 15	No data	Always 0

● Write Output Setting Timer Time Settings

It writes the output timer time settings of the sensor with the unit No. specified with the Instance ID. Its write data is expressed in hexadecimal and its length is two bytes; the data range is between 0000hex (0) and 1388hex (5000).

When the output setting timer function setting is OFF, [Output Setting Timer Time Settings] command fails if the command is sent.

● Write External Input Settings

It writes the output timer time settings of the sensor with the unit No. specified with the Instance ID.

Bit	Description	Data
00	Input setting	0: Teaching without a through-beam type workpiece
01		1: Teaching without a reflective type workpiece
02		2: Teaching with the workpiece or without a workpiece
03		3: Auto teaching 4: Power tuning (E3X, E3C) Fine positioning (E2C) 5: Zero reset 6: Projection lighting off (E3X) 7: Counter reset (RM, LDARM) 8: Sync detection input (E2C) 9: Position teaching
04 to 15	No data	Always 0

● Write External Input Memory Settings

It writes the external input memory settings of the sensor with the unit No. specified with the Instance ID.

Bit	Description	Data
00	External input memory settings	0: ON (write), 1: OFF (unwritten)
01 to 15	No data	Always 0

● Write Teaching Level Settings without a Workpiece

It writes the teaching level settings without a workpiece of the sensor with the unit No. specified with the Instance ID.

Its write data is expressed in hexadecimal and its length is two bytes; the data range is between 00hex (0) and 63hex (99).

● **Write Counter Settings**

It writes the counter settings of the sensor with the unit No. specified with the Instance ID.

Bit	Description	Data
00	Counter settings	0: Counter function disabled
01		1: Incremental counting 2: Decremental counting
02 to 15	No data	Always 0

● **Write Counter Value (Upper/Lower) Settings**

It writes the counter value (upper/lower) settings of the sensor with the unit No. specified with the Instance ID.

Counter value setting (upper 16 bits) (0000Hex to 05F5Hex)	Counter value setting (lower 16 bits) (0000Hex to FFFFHex)
---	---

When the counter function setting is OFF, [Write Counter Value (Upper) Settings] and [Write Counter Value (Lower) Settings] commands fail if either of the commands is sent.

● **Write Count Value (Upper/Lower)**

It writes the counter value (upper/lower) settings of the sensor with the unit No. specified with the Instance ID.

Count value (upper 16 bits) (0000Hex to 05F5Hex)	Count value (lower 16 bits) (0000Hex to FFFFHex)
--	--

● **Write Power Tuning Threshold Settings**

It writes the power tuning threshold settings of the sensor with the unit No. specified with the Instance ID.

Its write data is expressed in hexadecimal and its length is two bytes; the data range is between 0000hex (0) and 0FA0hex (4000).

● **Write ATC Function at Power Supply ON Settings**

It writes the ATC Function at Power Supply ON settings of the sensor with the unit No. specified with the Instance ID.

Bit	Description	Data
00	ATC Function at Power Supply ON settings	0: OFF, 1: ATC-Start,
01		2: Power tuning and ATC-Start
02 to 15	No data	Always 0

● **Write ATC Function Settings**

It writes the ATC Function settings of the sensor with the unit No. specified with the Instance ID.

Bit	Description	Data
00	ATC settings	0: OFF, 1: ON
01 to 15	No data	Always 0

● **Write Threshold Ratio Settings**

It writes the threshold ratio settings of the sensor with the unit No. specified with the Instance ID.

Threshold ratio settings															
Bit 15	Bit 14	Bit 13	Bit 12	Bit 11	Bit 10	Bit 09	Bit 08	Bit 07	Bit 06	Bit 05	Bit 04	Bit 03	Bit 02	Bit 01	Bit 00
0 Fixed			0: + / 1: -	0 Fixed				Threshold ratio settings (00Hex to 63Hex)							

● **Write Eco Mode Settings**

It writes the Eco mode settings of the sensor with the unit No. specified with the Instance ID.

Bit	Description	Data
00	Eco mode settings	0: OFF, 1: ECO1, 2: ECO2
01		
02 to 15	No data	Always 0

● **Write Setting Number of Mutual Interference Prevention Units**

It writes the setting number of mutual interference prevention units with the unit No. specified with the Instance ID.

Bit	Description	Data
00	Setting number of units for mutual interference prevention	0: OFF
01		1: 1 unit, 2: 2 units, 3: 3 units,
02		4: 4 units, 5: 5 units
03 to 15	No data	Always 0

Operation Instruction Commands

Executes an operation instruction such as teaching for connected sensors.
 When using an OMRON master, command/response formats are shown as follows:

● Command Format

Destination Node Address	Service Code	Class ID	Instance ID	Attribute ID
16 (Fixed)	009E (Fixed)			
1 byte	1 byte	2 bytes	2 bytes	1 byte

● Response Format

• Normal

Length of Received Bytes	Destination Node Address	Service Code
0002		96 (Fixed)
2 bytes	1 byte	1 byte

• Error

Length of Received Bytes	Destination Node Address	Service Code	Error Code
0004		94 (Fixed)	
2 bytes	1 byte	1 byte	2 bytes

■ Operation Instruction Command List

A list of Explicit Message Operation Instruction commands is shown below.

[Supported Models]

E3X-DA7-S, E3X-DA9-S: DA7, E3X-DA-S: DA, E3X-MDA: MDA, E3X-DATW-S: TW,
E3X-DARM-S: RM; E3X

E3C-LDA (2 output types): LDATW, E3C-LDA (input type): LDARM; E3C

E2C-EDA (2 output types): EDATW, E2C-EDA (input type): EDARM; E2C

Explicit Messages	Functions	Command			Supported Model
		Class ID	Instance ID	Attribute ID	
Set maximum sensitivity	With specifying a Unit No. with the Instance ID, sets the maximum sensitivity by issuing the command.	9E	Unit Number	30	E3X
Teaching without a Reflective Type Workpiece	With specifying a Unit No. with the Instance ID, performs teaching without a reflective type workpiece by issuing the command.	9E	Unit Number	31	All models
Teaching without a Through-beam Type Workpiece	With specifying a Unit No. with the Instance ID, performs teaching without a through-beam type workpiece by issuing the command.	9E	Unit Number	32	E3X, E3C
Teaching with the workpiece or without a workpiece (the First Point)	With specifying a Unit No. with the Instance ID, performs teaching for the first point with the workpiece or without a workpiece by issuing the command.	9E	Unit Number	33	All models
Teaching with the workpiece or without a workpiece (the Second Point)	With specifying a Unit No. with the Instance ID, performs teaching for the second point with the workpiece or without a workpiece by issuing the command.	9E	Unit Number	34	All models
Position Teaching (DA7 is executed by Teaching with the workpiece or without a workpiece)	With specifying a Unit No. with the Instance ID, performs position teaching by issuing the command	9E	Unit Number	37	E2C
Start Auto Teaching	With specifying a Unit No. with the Instance ID, starts auto teaching by issuing the command.	9E	Unit Number	35	All models
Stop Auto Teaching	With specifying a Unit No. with the Instance ID, stops auto teaching by issuing the command.	9E	Unit Number	36	All models
Execute Power Tuning	With specifying a Unit No. with the Instance ID, executes the power tuning by issuing the command.	9E	Unit Number	40	All models
Cancel Power Tuning	With specifying a Unit No. with the Instance ID, cancels the power tuning by issuing the command.	9E	Unit Number	43	All models
Execute Zero Reset	With specifying a Unit No. with the Instance ID, executes the zero reset by issuing the command.	9E	Unit Number	56	All models
Cancel Zero Reset	With specifying a Unit No. with the Instance ID, cancels the zero reset by issuing the command.	9E	Unit Number	57	All models

Explicit Messages	Functions	Command			Supported Model
		Class ID	Instance ID	Attribute ID	
Execute Projection Lighting Off	With specifying a Unit No. with the Instance ID, turns off the projection lighting by issuing the command.	9E	Unit Number	58	E3X, E3C
Cancel Projection Lighting Off	With specifying a Unit No. with the Instance ID, cancels the projection lighting that is turned off, by issuing the command.	9E	Unit Number	59	E3X, E3C
Reset Counter	With specifying a unit No. with the Instance ID, resets the counter by issuing the command.	9E	Unit Number	5A	RM, LDARM
Sensor Setting Initialization	With specifying a Unit No. with the Instance ID, resets all of the settings in the sensor to the default settings by issuing the command.	9E	Unit Number	45	All models
Reset	When the command is sent, all off the connected sensors are turned OFF and then turned ON to reset.	9E	Unit Number	6F	All models

Note 1: A range of unit Nos. in the Instance ID should be between 0001Hex and 0010Hex.



When two-point teaching and position teaching are performed, sending a command for the second point fails if no command for the first point is sent. Send a command for the second point after a command for the first point is sent.



The sensor setting initialization command resets the settings of each sensor to the default. The sensor reset command turns OFF the sensors and then turns them ON to reset the power.

Error Code List

Response Code	Error Name	Cause
08FF	Service not supported	An error is detected in the service code.
14FF	Invalid Attribute value	The specified Attribute value is not supported. The written data is out of the range. <ul style="list-style-type: none"> Number of connected sensors is no within 1 to 16 or no sensors are connected Number of units to be monitored for the detection level is not within 1 to 16 or no units to be monitored
16FF	Object does not exist	The specified Instance ID is not supported. <ul style="list-style-type: none"> The unit No. specified with the Instance ID is bigger than the number of mounted sensors.
15FF	Too much data	Data is longer than the specified size.
13FF	Not enough data	Data is shorter than the specified size.

Response Code	Error Name	Cause
0CFF	Object state conflict	<p>Cannot execute the specified command.</p> <ul style="list-style-type: none"> • The Mobile Console is connected. • Communications with a sensor fail. • The sensor mode is not RUN. • When two-point teaching and position teaching are performed, a command for the second point has been sent without a command for the first point. • A command that is not supported has been sent.(For example, a command to read digital values to a terminal unit is sent.)
20FF	Invalid Parameter	The specified operation instruction data is not supported.
0EFF	Attribute not settable	Write service code was sent to the Attribute ID that supports read only.

Example of Explicit Message Functions

An example of issuing Explicit messages using CS1W-DRM21 is shown below.

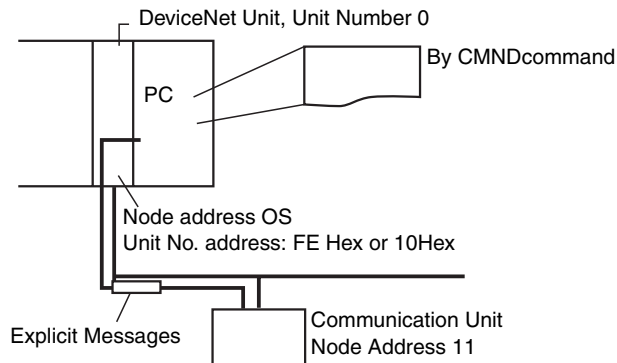

● Operations

- It writes threshold values for the sensor (unit No. 1) connected to the communication unit.
- Use the [Send Explicit Message] command (28 01) to read data.
- Command data is written starting at D01000 of the PC body, and the response data is stored starting at D02000.
- When the command fails, the terminate code is stored in D00006, and then the same send command is resent.

● Command Details

[CMND S D C]

- S D01000+0 : 2801 Hex Command code
 +1 : 0B10 Hex Communication unit node address 11, ServiceCode 10 Hex
 +2 : 009C Hex ClassID 009C Hex
 +3 : 0001 Hex InstanceID 0001 Hex
 +4 : 11FF Hex AttributeID 11 Hex + write data lower byte FF Hex
 +5 : 0700 Hex Write data upper byte 07 Hex
- D D02000 : Head CH number for response store
- C D00000+0 : 000B Hex Byte length of command data
 +1 : 0008 Hex Byte length of response data
 +2 : 0001 Hex Target (destination) network address 1
 +3 : 05FE Hex Target (destination) node address: 5, target (destination) unit No. address: FE Hex (10Hex is also acceptable)
 +4 : 0000 Hex Response required, communication port No. 0, retry number: 0 Hex
 +5 : 00C8 Hex Response monitoring time: 20 seconds

● Response

- D 02000 +0 : 2801 Hex
 +1 : 0000 Hex
 +2 : 0002 Hex
 +3 : 0B90 Hex Response source node address: 11 (0BHex), normal completion: 90Hex

● Program Example

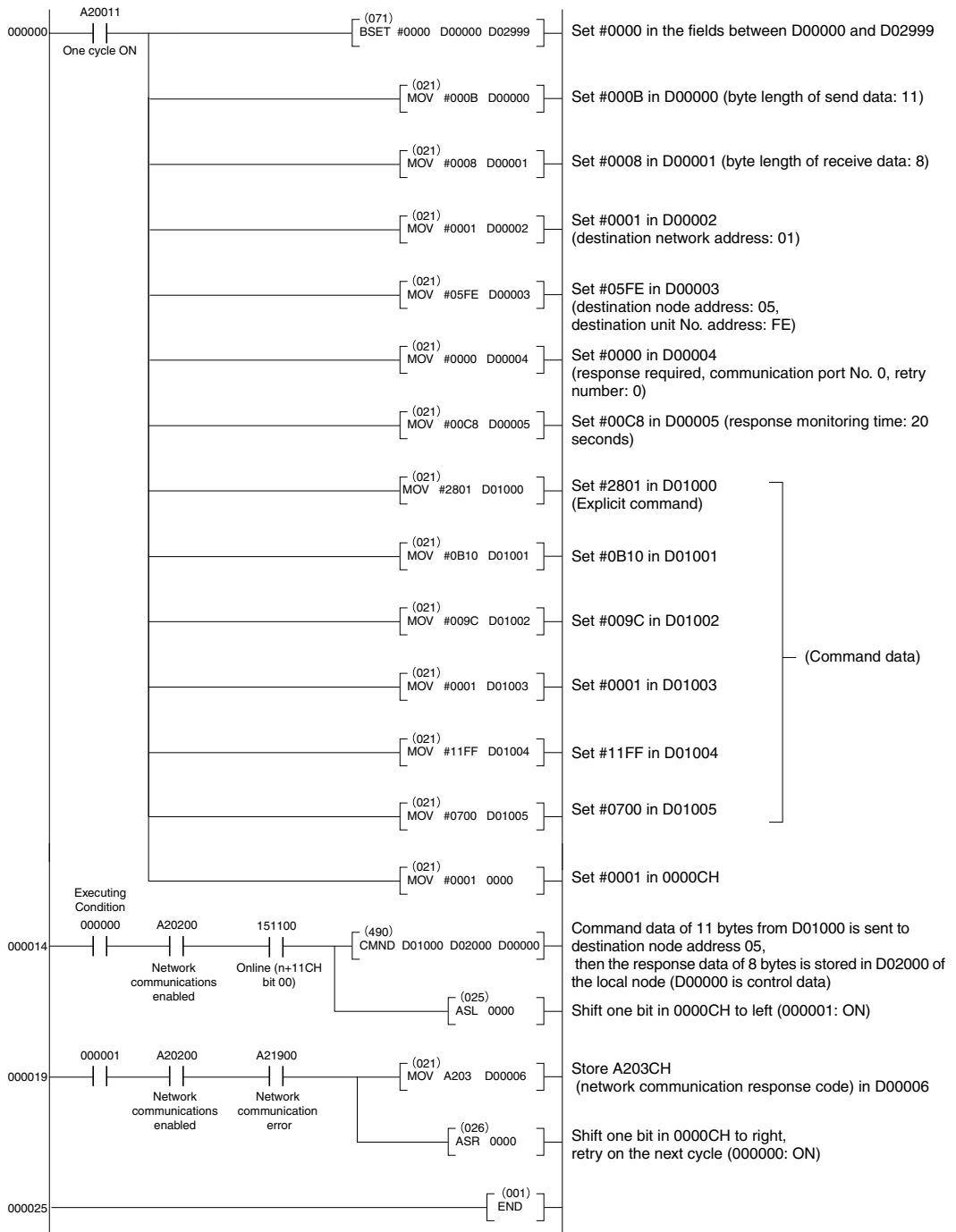

END

Sensor Setting/Monitoring/Operating Functions from Configurator

Overview

The DeviceNet Configurator (Ver. 2.10 or higher) can be used to edit and monitor device parameters to support the following setting, monitoring, and operating functions.

● Setting and Downloading for Each Sensor

- Threshold value
- Operating mode
- Detection mode
- Differentiation edge selection
- Differentiation mode response time
- Timer function
- Timer time
- On-delay and OFF-delay timer time
- Display switching
- MODE key
- Display direction
- Power tuning target value
- Output settings
- Output setting timer function
- External input settings
- Output setting timer function
- External input memory settings
- Counter settings
- Counter value
- Power tuning threshold settings
- Power tuning settings
- Eco mode settings
- Zero reset level
- Teaching level settings without a workpiece
- Number of units for mutual interference prevention
- Key lock settings

● Monitoring Communication Unit

- Sensor ON/OFF data
- Detection level
- Detection level when ON
- Detection level when OFF
- Normally communicating with sensors
- Number of sensors to be communicating

● Operation Instructions for Each Sensor

- Set maximum sensitivity
- Teaching without a reflective workpiece
- Teaching without a through-beam workpiece
- Teaching with the workpiece or without a workpiece
- Start auto teaching
- Stop auto teaching
- Position teaching
- Power tuning settings
- Hyper teaching
- Zero reset
- Cancel zero reset
- Stop projection lighting
- Start projection lighting
- Reset counter

● Maintenance Information of Each Sensor

Running time of the head and amplifier of each sensor can be monitored.

Setting the Communication Unit and Sensors, and Downloading

Generally, setting communication units and each sensor is done by the following procedures.

1. Select and double-click the applicable communication unit. The following [Edit Device Parameters] dialog box will appear.

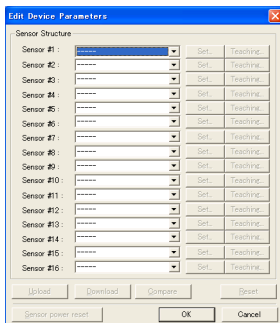

2. Edit each parameter.

- Settings of each sensor (fiber amplifier unit)

- 1) [Click the ▼] button on the right of [Sensor #xx] (xx is unit No.) in the [Sensor Configuration] field, then select a fiber amplifier unit type from the pull-down list.

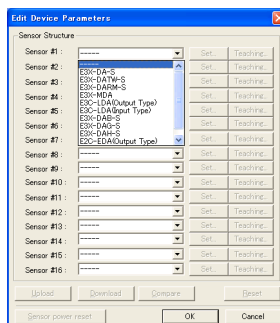

- 2) Click the [Set...] button on the right of the registered fiber amplifier unit type. The following [Edit Sensor Parameters] dialog box will appear.

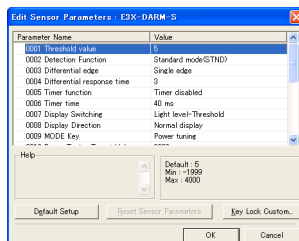

3) In the [Edit Sensor Parameters] dialog box, configure the following settings (depending on the fiber amplifier unit type, shown items vary):

- Threshold value
- Operating mode
- Detection mode
- Differentiation edge selection
- Differentiation mode response time
- Timer function
- Timer time
- On-delay and OFF-delay timer time
- Display switching
- MODE key
- Display direction
- Power tuning target value
- Output settings
- Output setting timer function
- External input settings
- Output setting timer function
- External input memory settings
- Counter settings
- Counter value
- Power tuning threshold settings
- Power tuning settings
- HYS
- Eco mode settings
- Zero reset level
- Teaching level settings without a workpiece
- Number of units for mutual interference prevention
- Threshold for the amplifier unit head running time

In the key lock custom, configure MODE key, threshold fine-tuning, SET mode, and key lock executing and cancelling of teaching.

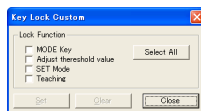

3. After all of the settings of the sensor are configured, return to [Edit Device Parameters] dialog box.
4. Switch the Configurator to online (select [Network] - [Connection]).
5. In the [Edit Device Parameters], click the [Download] button.

Uploading to Communication Unit and Monitoring/ Setting Parameters Online

Monitor communication units by using the following procedures.

● Monitoring communication units

1. Switch the Configurator to online (select [Network] - [Connection]).
2. Select [Network] - [Upload] to upload network configuration.
3. Select and double-click the applicable communication unit.

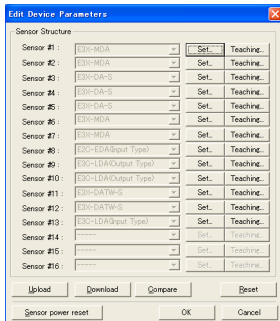

4. Click the [Set...] button on the right of the fiber amplifier unit type to monitor the current settings.

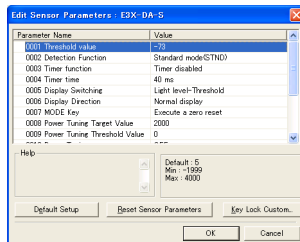

5. Change the settings and click the [Download] button in the [Edit Device Parameters].

Operation Instructions for Each Sensor (Fiber Amplifier Unit)

1. Switch the Configurator to online (select [Network] - [Connection]).
2. Select and double-click the applicable communication unit.
3. In the [Edit Device Parameters] dialog box, click the [Teaching...] button on the right of the registered fiber amplifier unit type.

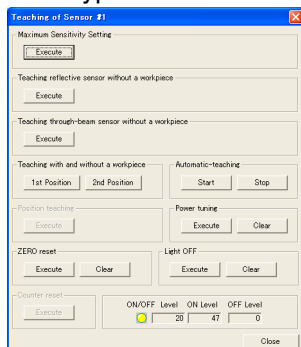

4. In the [Teaching of Sensor #xx] dialog box, configure the following settings.

- Set maximum sensitivity
- Teaching without a reflective workpiece
- Teaching without a through-beam workpiece
- Teaching with the workpiece or without a workpiece
- Start auto teaching
- Stop auto teaching
- Position teaching
- Power tuning settings
- Hyper teaching
- Zero reset
- Cancel zero reset
- Stop projection lighting
- Start projection lighting
- Reset counter

In the bottom right, the sensor's ON/OFF, the detection level, the detection level when ON, and the detection level when OFF are shown.

Online Monitoring

Monitor communication units by using the following procedures.

1. Switch the Configurator to online (select [Network] - [Connection]).
2. Select a communication unit and right-click it to select [Monitor].
3. Monitor from the following screen.

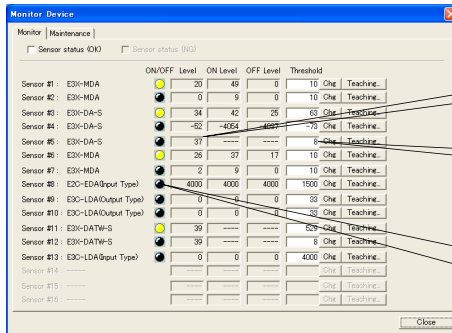

Monitor detection levels for each sensor.

Set set threshold values.

Monitor ON/OFF state. Yellow means ON; black means OFF.

4. Set threshold values on the monitor screen.

When you select [Change] after you modify a threshold value, the new value is set to the sensor.

5. Select [Teaching...] to instruct operations to each sensor.

Sensor Maintenance

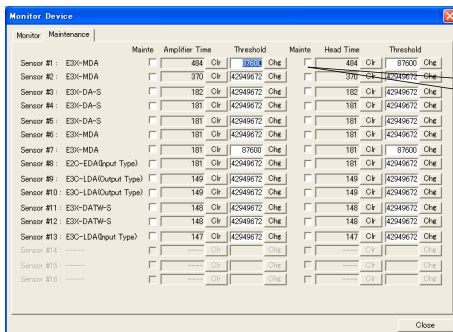

When a value exceeds its threshold value, the corresponding checkbox is checked.

Select the [Maintenance] on the monitor screen to show the maintenance screen for the sensors.

On the maintenance screen, the electrification time of the head and amplifier of each sensor is displayed.

Electrification time threshold value for the head and amplifier (configured in the sensor amplifier unit settings) will appear in each box when the electrification time of the head and/or amplifier exceeds the corresponding value.

Select [Clear] to reset the electrification time to 0.

Section 4

APPENDIX

☒ Communications Timing	84
Communications Timing	84
☒ Errors and Countermeasures	86
☒ DeviceNet Connection Settings	88
Setting Connections without Using Configurator	88
Changing Connections Using the Configurator	89
☒ DeviceNet Device Profile	95
Device Profile	95
Mounted Objects	96

Communications Timing

Communications Timing

This appendix describes the internal processing times for the communication unit. For details of communication times for DeviceNet master, refer to the relevant user's manuals.

■ Maximum ON/OFF Output Data Input Delay Time

The maximum delay time is as follows:

- With up to 8 Sensors connected:
Maximum ON/OFF output data input delay time for Unit $n = 0.1 \times n + 2.5$ (ms)
- With 9 or more Sensors connected:
Maximum ON/OFF output data input delay time for Unit $n = 0.2 \times n + 2.5$ (ms)

■ Maximum Update Cycle of Detection level Data

The following tables list the maximum values for the update cycle of the detection level monitoring when the Unit is operating with remote I/O communications in 2-channel mode with the detection level monitoring mode (SW1 =OFF, SW2 = ON).

The maximum update cycle of the detection level monitoring depends on whether Explicit messages are used and on the number of Sensors connected, as shown in the tables below.

• When using Explicit Messages

Number of connected Sensors	Maximum update cycle of detection level monitoring (ms)
1	50
2	100
3	160
4	240
5	330
6	430
7	540
8	670

Number of connected Sensors	Maximum update cycle of detection level monitoring (ms)
9	2300
10	2500
11	3000
12	3300
13	3600
14	4200
15	4600
16	4900

Explicit messages are also used when a configurator is connected.

• When not using Explicit Messages

Number of connected Sensors	Maximum update cycle of detection level monitoring (ms)
1	20
2	40
3	60
4	90
5	110
6	140
7	170
8	200

Number of connected Sensors	Maximum update cycle of detection level monitoring (ms)
9	1500
10	1900
11	2000
12	2200
13	2300
14	2400
15	3000
16	3200



Normally, the update cycle of the detection level is much shorter than the values listed in the tables above. However, the update cycles can be extended with some timings. Consider the maximum refresh cycle when designing the system.

Errors and Countermeasures

The following table describes the LED statuses, probable causes and countermeasures.

LED status	Probable causes	Countermeasure
MS and NS LED not lit.	Power is not supplied to the Unit.	Supply the communications power to the Unit through the DeviceNet communications connector.
	Supply voltage is outside the permissible range.	Use the supply voltage within the permissible range.
	The Unit is damaged.	Replace the Unit.
MS LED lit red.	The Unit is damaged.	Replace the Unit.
MS LED lit green. NS LED flashing green.	DeviceNet Communications The Unit is waiting for connection to DeviceNet communications.	Check the following items and then restart the Unit. <ul style="list-style-type: none"> • Are cable lengths (trunk/branch lines) appropriate? • Are cables shorted, broken, or loose? • Is the wiring correct? • Is terminating resistance connected to both ends of the trunk line only? • Is there too much noise? • Is the power turned ON to the master?
	The Unit is damaged.	Replace the Unit.
MS LED lit green. NS LED lit red.	DeviceNet is in Busoff status.	Check the following items and then restart the Unit. <ul style="list-style-type: none"> • Are cable lengths (trunk/branch lines) appropriate? • Are cables shorted, broken, or loose? • Is terminating resistance connected to both ends of the trunk line only? • Is there too much noise?
	The same node address has been assigned to two or more nodes.	Set the node addresses correctly.
	The Unit is damaged.	Replace the Unit.
MS LED lit green. NS LED flashing red.	A communications timeout error has occurred.	Check the following items and then restart the Unit. <ul style="list-style-type: none"> • Are cable lengths (trunk/branch lines) appropriate? • Are cables shorted, broken, or loose? • Is terminating resistance connected to both ends of the trunk line only? • Is there too much noise?
	The Unit is damaged.	Replace the Unit.
SS LED not lit.	No Sensors are connected.	Connect the Sensors correctly.
	The Sensors adjacent to the communication unit are damaged.	Replace the Unit adjacent to the communication unit.
	The power is turned ON while the Mobile Console was connected.	Temporarily disconnect the Mobile Console.
	The Unit is damaged.	Replace the Unit.



LED status	Probable causes	Countermeasure
SS LED lit red.	One or more of the connected Sensors are damaged.	Replace the Sensors. Determine which Sensors are damaged by checking the number of Sensors that can be communicated with.
	One or more of the connected Sensors has been connected improperly.	Connect the Sensors correctly. Determine the Sensor error location by checking the number of Sensors that can be communicated with.
	The number of registered Sensors is incorrect.	Register the number of Sensors correctly.
	Sensors with unsupported lot numbers are included.	Replace the unsupported Sensors with the supported Sensors.  "Connecting Sensors" on p. 22
	The number of connected Sensors is more than the limit.	Connect a number of Sensors that is within the limit.
	The reset switch was pressed while the Mobile Console was connected.	Temporarily disconnect the Mobile Console.
	The Unit is damaged.	Replace the Unit.

DeviceNet Connection Settings

DeviceNet supports different protocols for remote I/O communications between master and slave devices. Connection is a unit used to manage those protocols. The connections can be set using the configurator.

The DeviceNet remote I/O communications protocol supports four types of connections: Poll, Bit-Strobe, COS (Change of state), and Cyclic.

The features of these connections are listed in the following table. The Sensor communication unit supports all the protocols.

Connection	Description	
Poll	Used for basic I/O.	
Bit-Strobe	Used for input of 8 bytes or less. Sends broadcasting requests from master and receives input from slaves.	 Poll and Bit-Strobe connections cannot be used at the same time. CHECK!
COS (Change of state)	This connection can be used to send data to the master from the communication unit only when the data changes. Transmission timing is determined by a heartbeat timer. Data can be sent only when required, thereby reducing the communications load on the network.	 COS and Cyclic connections cannot be used at the same time. CHECK!
Cyclic	Communications timing is determined by regular cycles (heartbeat timer). The communication unit will send data at a regular cycle.	



To use COS and Cyclic connections, the DeviceNet master must support those functions. Confirm that the master supports COS and Cyclic connections before using them.
OMRON products, such as the CS1W-DRM21 and CJ1W-DRM21, support COS and Cyclic connections.

Setting Connections without Using Configurator

The connections used for all the IN data of the Sensor communication unit are as follows:

- Data of 8 bytes or less: Bit-Strobe
- Data of more than 8 bytes: Poll

Changing Connections Using the Configurator

When a CS1W-DRM21 is used as the DeviceNet master, the OMRON Configurator (version 2.10 or later) can be used to change the connections. The procedure is as follows:

■ Step 1: Connecting the Configurator

1. Connect the DeviceNet configurator.

The parameter of the master as well as the Sensor communication unit settings are changed, so connect the master that will actually be used.

2. Turn ON the power, and put the configurator online.
3. Upload the network configuration.

■ Step 2: Selecting the Group

For the Communication Unit, IN data assignments are divided into the following groups.

Group	Data	Number of bytes	Connection path
(1)	ON/OFF output data with status	2 bytes fixed	200424013003
(2)	ON/OFF output data	2 bytes fixed	200424023003
(3)	Status data	2 bytes fixed	200424033003
(4)	Detection level data	2 bytes x Number of monitors for the detection level	200424043003
(5)	ON/OFF output data + Status data	4 bytes fixed	200424053003
(6)	Status data + Detection level data	2 bytes + (2 bytes x Number of monitors for the detection level)	200424063003
(7)	ON/OFF output data + Status data + Detection level data	4 bytes + (2 bytes x Number of monitors for the detection level)	200424073003

Details of data for each group are as follows:

(1) ON/OFF output data with status

Bit 15	Communicating with Sensor
Bit 14	Sensor communications error
Bit 13	Communicating with Mobile Console
Bit 12	Unit No. 13 ON/OFF output data
Bit 11	Unit No. 12 ON/OFF output data
Bit 10	Unit No. 11 ON/OFF output data
Bit 9	Unit No. 10 ON/OFF output data
Bit 8	Unit No. 9 ON/OFF output data

Bit 7	Unit No. 8 ON/OFF output data
Bit 6	Unit No. 7 ON/OFF output data
Bit 5	Unit No. 6 ON/OFF output data
Bit 4	Unit No. 5 ON/OFF output data
Bit 3	4Unit No. 8 ON/OFF output data
Bit 2	Unit No. 3 ON/OFF output data
Bit 1	Unit No. 2 ON/OFF output data
Bit 0	Unit No. 1 ON/OFF output data

(2) ON/OFF output data

Bit 15	Unit No. 16 ON/OFF output data	Bit 7	Unit No. 8 ON/OFF output data
Bit 14	Unit No. 15 ON/OFF output data	Bit 6	Unit No. 7 ON/OFF output data
Bit 13	Unit No. 14 ON/OFF output data	Bit 5	Unit No. 6 ON/OFF output data
Bit 12	Unit No. 13 ON/OFF output data	Bit 4	Unit No. 5 ON/OFF output data
Bit 11	Unit No. 12 ON/OFF output data	Bit 3	4Unit No. 8 ON/OFF output data
Bit 10	Unit No. 11 ON/OFF output data	Bit 2	Unit No. 3 ON/OFF output data
Bit 9	Unit No. 10 ON/OFF output data	Bit 1	Unit No. 2 ON/OFF output data
Bit 8	Unit No. 9 ON/OFF output data	Bit 0	Unit No. 1 ON/OFF output data

(3) Status data

Bit 15	Communicating with E3X	Bit 7	0 (Fixed)
Bit 14	E3X communications error	Bit 6	0 (Fixed)
Bit 13	Communicating with Mobile Console	Bit 5	Setting change for the number of registered units
Bit 12	Number of sensors that can be communicated with (2 ⁴)	Bit 4	Number of connected Sensors(2 ⁴)
Bit 11	Number of sensors that can be communicated with (2 ³)	Bit 3	Number of connected Sensors(2 ³)
Bit 10	Number of sensors that can be communicated with (2 ²)	Bit 2	Number of connected Sensors(2 ²)
Bit 9	Number of sensors that can be communicated with (2 ¹)	Bit 1	Number of connected Sensors(2 ¹)
Bit 8	Number of sensors that can be communicated with (2 ⁰)	Bit 0	Number of connected Sensors(2 ⁰)

(4) Detection level data

	Bit 15	Bit 14	Bit 13	Bit 12	Bit 11	Bit 10	Bit 09	Bit 08	Bit 07	Bit 06	Bit 05	Bit 04	Bit 03	Bit 02	Bit 01	Bit 00
mCH	Unit No. 1 Detection level															
m + 1CH	Unit No. 2 Detection level															
m + 2CH	Unit No. 3 Detection level															
.	.															
.	.															
.	.															
m + n - 2CH	Unit No. n - 1 Detection level															
m + n - 1CH	Unit No. n Detection level															

Number of monitors for the detection level: n

(5) ON/OFF output data + Status data

	Bit 15	Bit 14	Bit 13	Bit 12	Bit 11	Bit 10	Bit 09	Bit 08	Bit 07	Bit 06	Bit 05	Bit 04	Bit 03	Bit 02	Bit 01	Bit 00
mCH	ON/OFF output data (same contents as (2))															
m + 1CH	Status data (same contents as (3))															

(6) Status data + Detection level data

	Bit 15	Bit 14	Bit 13	Bit 12	Bit 11	Bit 10	Bit 09	Bit 08	Bit 07	Bit 06	Bit 05	Bit 04	Bit 03	Bit 02	Bit 01	Bit 00
mCH	Status data (same contents as (3))															
m + 1CH	Unit No. 1 Detection level															
m + 2CH	Unit No. 2 Detection level															
.	.															
.	.															
.	.															
m + n - 1CH	Unit No. n - 1 Detection level															
m + nCH	Unit No. n Detection level															

(7) ON/OFF output data + Status data + Detection level data

	Bit 15	Bit 14	Bit 13	Bit 12	Bit 11	Bit 10	Bit 09	Bit 08	Bit 07	Bit 06	Bit 05	Bit 04	Bit 03	Bit 02	Bit 01	Bit 00
mCH	ON/OFF output data (same contents as (2))															
m + 1CH	Status data (same contents as (3))															
m + 2CH	Unit No. 1 Detection level															
.	.															
.	.															
.	.															
m + nCH	Unit No. n - 1 Detection level															
m + n + 1CH	Unit No. n Detection level															

Number of monitors for the detection level: n

Assign any two of (1) to (7) to Poll, Bit-Strobe, COS, or Cyclic connection.

However, Poll and Bit-Strobe cannot be used at the same time. COS and Cyclic also cannot be used at the same time. For Bit-strobe, 8 bytes or more of data cannot be assigned.

Example:

Bit-Strobe: (2) ON/OFF output data

COS: (6) Status data + Detection level data

■ Step 3: Setting the Communication Unit

1. Set the number of bytes for each connection.
2. Select the communication unit to be set from the configurator screen, and then right-click the mouse button.
3. Select [Property] from the menu.
4. Open the [I/O Information].
5. Click the [Edit] button.
6. The following dialog box will be displayed. Set the connection and number of bytes to be used.

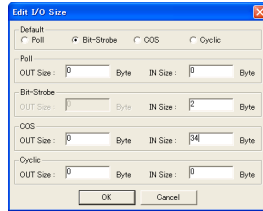

Example:

Bit-Strobe: ON/OFF output data

COS: Status data + Detection level data

When number of monitors for detection level is 16, settings for this example are as follows:

Bit-Strobe: 2 bytes

COS: 34 bytes (2 bytes x 16 units + 2 bytes)



CHECK!

The above items will be returned to the default settings when the configurator is restarted or a configuration is uploaded. Therefore, errors may occur when operating the configurator. Be sure to reset the above items to prevent errors from occurring.

■ Step 4: Setting the DeviceNet Master

1. Select and double-click the DeviceNet master.
2. Register the communication unit if it has not been previously registered as a registered device.
3. Select the communication unit and click the [Advanced Settings] button.
4. Open the [Connection].
5. The following dialog box will be displayed. Select [User Setup] and set the connection path.

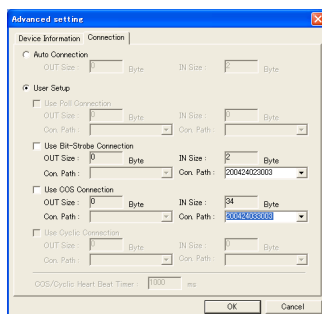

■ Step 5: Setting the COS/Cyclic Heartbeat Timer

From the screen displayed in step 4, set the COS/Cyclic heartbeat timer.

1. For a Cyclic connection, data is periodically sent by the slave in a cycle determined by this setting.
2. For a COS connection, data is periodically sent by the slave in a cycle determined by this setting even if the data has not changed, and checks that a communications error has not occurred.
The higher the value is, the lesser the load on the network is. However, the time required to detect errors is longer with higher values.

■ Step 6: Master I/O Allocations

1. Select [I/O Allocation (IN)] to display the following screen.
2. Select and double-click the communication unit to be allocated.
3. The following dialog box will be displayed. Set the values for each item to allocate I/O. (If the memory block 2 is used, click the [Memory Change] button and set the area beforehand.)

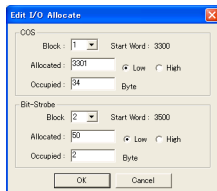

DeviceNet Device Profile

Device Profile

General data	Compatible DeviceNet specifications	Volume - Release 2.0 Volume - Release 2.0	
	Vendor name	OMRON Corporation	Vendor ID = 47
	Device profile name	Communication Adapter	Profile number = 12
	Product catalog number		
	Product revision	1.01	
Physical conformance data	Network current consumption	24 VDC, 70 mA max. (*1)	
	Connector type	Open plug	
	Physical insulation	None	
	Supported LEDs	Module, Network	
	MAC ID setting	DIP switch	
	Default MAC ID	0	
	Transmission baud rate setting	Automatic tracking	
	Supported transmission baud rate	125 kbit/s, 250 kbit/s, 500 kbit/s	
Communications data	Predefined master/slave connection set	Group 2 only server	
	Dynamic connection support (UCMM)	None	
	Explicit message fragmentation support	Yes	

(*1) The current supplied to Sensors is excluded.

Mounted Objects

● Identity Object (01 Hex)

Object class	Attribute	Not supported.
	Service	Not supported.

Object instance	Attribute	ID	Description	Get	Set	Value
		1	Vendor	Yes	No	47
		2	Product type	Yes	No	12
		3	Product code	Yes	No	149
		4	Revision	Yes	No	1.01
		5	Status (bits supported)	Yes	No	
		6	Serial number	Yes	No	Per unit
		7	Product name	Yes	No	E3X-DRT21-S
		8	State	No	No	
	Service		DeviceNet service	Parameter option		
		05	Reset	None		
		0E	Get_Attribute_Single	None		

Index

C

Cable Color	39
Communicating with a sensor (DeviceNet Explicit Message Communications)	50
Communicating with Sensor (DeviceNet Type)	40
Communicating with the Mobile Console (DeviceNet Type)	40
Connecting Sensors (connectable Sensors)	22
Connectors with cable	22
Cordless connector	22

D

DeviceNet Connection Settings	88
Dip Switches (DeviceNet Type)	36

E

Explicit Message Communications	44
External Dimensions	21

F

Features of DeviceNet communication type	17
--	----

I

Installation	25
--------------	----

M

Maximum ON/OFF Data Input Delay Time	84
Maximum Update Cycle of Amount of Detection Level Data	85
Message Communications	30
MS LED (DeviceNet Type)	35

N

NS LED (DeviceNet Type)	35
Number of Connectable Sensors	23
Number of connected Sensors (DeviceNet type)	24

O

Operating Mode Settings (SW1, SW2) (DeviceNet Type)	36
---	----

Operation Instruction Command List (DeviceNet Explicit Message Communications)	71
--	----

P

Power supply to Sensors	20
Prewired models	22

R

Read Command List (DeviceNet Explicit Message Communications)	47
Read Number of Connected Sensors (DeviceNet Explicit Message Communications)	59
Read ON/OFF dta (DeviceNet Explicit Message communications)	47
Read Status (DeviceNet Explicit Message Communications)	49
Read threshold settings (DeviceNet Explicit Message Communications)	52
Read Timer Time (DeviceNet Explicit Message Communications)	54
Remote I/O Communications	29
Remote I/O communications 1CH mode	29
Remote I/O communications 2CH + detection level monitor mode	29
Remote I/O communications 2CH mode	29
Rotary Switches (DeviceNet Type)	35

S

Sensor communication error (DeviceNet Type)	40
Sensor communications error (DeviceNet Explicit Message Communications)	50
Sensor Reset Switch (DeviceNet type)	24
Sensor Setting/Monitoring/Operation Functions from Configurator	76
Setting change for the Number of connected Sensors (DeviceNet type)	24
SS LED (DeviceNet Type)	35

System configuration for DeviceNet
communication type 18

U

Unit Number 23

W

Wiring DeviceNet Communication
Type 39
Write Command List (DeviceNet
Explicit Message Communications) 61
Write Threshold Settings (DeviceNet
Explicit Message Communications) 64
Write Timer Time (DeviceNet Explicit
Message Communications) 67

MEMO

Revision History

A manual revision code appears as a suffix to the catalog number on the front cover of the manual.

Cat. No. Z223-E1-03

↑
Revision code

Revision code	Date	Revised content
01	February 2005	Original production
02	March 2006	Pages 16 and 28: Note changed. Pages 18: "(Uses a cordless slave connector.)" removed from illustration. Page 20: Specifications for connectable Sensors changed. Page 22: Text before and after table changed. Pages 29 and 30: "(can be connected only with a cordless slave connector)" removed from illustration. Page 68: Response code 09FF corrected to 14FF. Page 92: Product code 145 corrected to 149.
03	October 2008	E3X-DA-S high performance type model addition.

OMRON Corporation
Industrial Automation Company
Sensing Devices Division H.Q.
Industrial Sensors Division

Shiokoji Horikawa, Shimogyo-ku,
Kyoto, 600-8530 Japan
Tel: (81)75-344-7022/Fax: (81)75-344-7107

Regional Headquarters

OMRON EUROPE B.V.

Sensor Business Unit

Carl-Benz-Str. 4, D-71154 Nufringen,
Germany
Tel: (49) 7032-811-0/Fax: (49) 7032-811-199

OMRON ELECTRONICS LLC

One Commerce Drive Schaumburg,
IL 60173-5302 U.S.A.
Tel: (1) 847-843-7900/Fax: (1) 847-843-7787

OMRON ASIA PACIFIC PTE. LTD.

No. 438A Alexandra Road # 05-05/08 (Lobby 2),
Alexandra Technopark, Singapore 119967
Tel: (65) 6835-3011/Fax: (65) 6835-2711

OMRON (CHINA) CO., LTD.

Room 2211, Bank of China Tower,
200 Yin Cheng Zhong Road,
PuDong New Area, Shanghai, 200120, China
Tel: (86) 21-5037-2222/Fax: (86) 21-5037-2200

Authorized Distributor:

© OMRON Corporation 2005 All Rights Reserved.
In the interest of product improvement,
specifications are subject to change without notice.