

The OMRON logo is displayed in a bold, blue, sans-serif font. The letters are thick and rounded, with a consistent blue color throughout. The logo is centered horizontally within a light yellow rectangular background.

Automatización Eléctrica
Especialistas en Automatización

At the end of this document you will find links to products related to this catalog. You can go directly to our shop by clicking [HERE](#). [HERE](#)

SYSMAC

CXONE-□□□□C-V□/CXONE-□□□□D-V□

CX-Drive

OPERATION MANUAL

OMRON

CXONE-□□□□C-V□/

CXONE-□□□□D-V□

CX-Drive

Operation Manual

Revised June 2013

Notice:

OMRON products are manufactured for use according to proper procedures by a qualified operator and only for the purposes described in this manual.

The following conventions are used to indicate and classify precautions in this manual. Always heed the information provided with them. Failure to heed precautions can result in injury to people or damage to property.



DANGER

Indicates an imminently hazardous situation which, if not avoided, will result in death or serious injury. Additionally, there may be severe property damage.



WARNING

Indicates a potentially hazardous situation which, if not avoided, could result in death or serious injury. Additionally, there may be severe property damage.



Caution

Indicates a potentially hazardous situation which, if not avoided, may result in minor or moderate injury, or property damage.

OMRON Product References

All OMRON products are capitalized in this manual. The word “Unit” is also capitalized when it refers to an OMRON product, regardless of whether or not it appears in the proper name of the product.

The abbreviation “Ch,” which appears in some displays and on some OMRON products, often means “word” and is abbreviated “Wd” in documentation in this sense.

The abbreviation “PLC” means Programmable Controller. “PC” is used, however, in some Programming Device displays to mean Programmable Controller.

Visual Aids

The following headings appear in the left column of the manual to help you locate different types of information.

Note Indicates information of particular interest for efficient and convenient operation of the product.

1,2,3... 1. Indicates lists of one sort or another, such as procedures, checklists, etc.

© OMRON, 2005

All rights reserved. No part of this publication may be reproduced, stored in a retrieval system, or transmitted, in any form, or by any means, mechanical, electronic, photocopying, recording, or otherwise, without the prior written permission of OMRON.

No patent liability is assumed with respect to the use of the information contained herein. Moreover, because OMRON is constantly striving to improve its high-quality products, the information contained in this manual is subject to change without notice. Every precaution has been taken in the preparation of this manual. Nevertheless, OMRON assumes no responsibility for errors or omissions. Neither is any liability assumed for damages resulting from the use of the information contained in this publication.

TABLE OF CONTENTS

PRECAUTIONS	xv
1 Intended Audience	xvi
2 General Precautions	xvi
3 Safety Precautions	xvi
4 Application Precautions	xvii
SECTION 1	
Overview	1
1-1 Introduction	2
What Is the CX-Drive?	2
Features	2
Applicable Drives and Communications	4
Files Created by CX-Drive	5
Computer System Requirements	5
Confirming Product Contents	5
1-2 Installation	6
Required Software	6
1-3 System Configuration	7
Inverter Connection	7
Servo Connection	14
SECTION 2	
Basic Operations	21
2-1 Overall Operating Procedure	22
Inverters	22
Servo	24
2-2 Starting the CX-Drive	26
2-3 Creating New Drive Files	27
Method 1: Automatically Detecting the Connected Drives	27
Method 2: Creating a New Data File without a Connected Drive	30
2-4 User Interface	39
Window Structure	39
Functions	39
Menu Commands	46
2-5 Editing Drive Files	49
Editing Parameters	50
Graphs	51
Diagrams	51
Status Displays	52
Monitoring	52
Data Trace	53
Auto Tune	54
Test Run	55
FFT	55
Damping Control	56
Quick Parameter Setup	57
Motor Setup	57
Settings	58
Revision History	59

TABLE OF CONTENTS

About this Manual:

This manual provides information required to use the CX-Drive Inverter/Servo Support Software, including specifications and operating methods. The CX-Drive runs on Windows XP, Vista, or Windows 7 and is used to set, transfer, and compare parameters; perform test runs and adjustment; and performing monitoring and data tracing for OMRON Inverters and Servos.

Please read this manual carefully and be sure you understand the information provided before attempting to use the CX-Drive. Be sure to read the precautions provided in the following section.

Please read the relevant Inverter or Servo manuals carefully and be sure you understand the information provided before setting up or using an application for a drive.

Drive type	Manual Name	Cat. No. (suffixes omitted)
Inverters	SYSDRIVE JX Series Models 3G3JX Compact Simplified Inverters User's Manual	I558-E1
	SYSDRIVE MX Series Models 3G3MX Multi-function Compact Inverters User's Manual	I559-E1
	SYSDRIVE RX Series Models 3G3RX High-function General-purpose Inverters User's Manual	I560-E1
	SYSDRIVE RX-V1 Series High-function General-purpose Inverter User's Manual	I578-E1
	SYSDRIVE MX2 Series Models 3G3MX2 Multi-Function Compact Inverters User's Manual	I570-E1
	SYSDRIVE 3G3JV Compact Simplified Inverters User's Manual	I528-E1
	SYSDRIVE 3G3MV Multi-function Compact Inverters User's Manual	I527-E1
	SYSDRIVE RV Series Models 3G3RV High-function General-purpose Inverters User's Manual	I532-E1
	SYSDRIVE RV Series Models 3G3RV-V1 High-function General-purpose Inverters Setup Manual	I549-E1
	DeviceNet Communications Unit/Card 3G3MV-PDRT2, 3G3RV-PDRT2 User's Manual	I539-E1
	EtherCAT Communication Unit 3G3AX-MX2-ECT/3G3AX-RX-ECT User's Manual	I574-E1
	DeviceNet Communications Unit 3G3AX-MX2-DRT-E, 3G3AX-RX-DRT-E User's Manual for SYSDRIVE MX2/RX Series	I581-E1
	CompoNet Communications Unit 3G3AX-MX2-CRT-E, 3G3AX-RX-CRT-E User's Manual for SYSDRIVE MX2/RX Series	I582-E1
MX2/RX Series Drive Programming User's Manual	I580-E1	
Servomotors/ Servo Drives	SMARTSTEP2 Series Servomotors/Servo Drives Models R88M-G□ (Servo-motors)/R7D-BP□ (Servo Drives) User's Manual	I561-E1
	OMNUC G5 Series Models R88M-K□ (AC Servomotors)/Models R88D-KT□ (AC Servo Drives) AC Servomotors/Servo Drives User's Manual	I571-E1
	OMNUC G5 Series AC Servomotors/Servo Drives with Built-in MECHATROLINK-II Communications Models R88M-K□ (AC Servomotors)/R88D-KN□-ML2 (AC Servo Drives) User's Manual	I572-E1
	OMNUC G5 Series AC Servomotors/Servo Drives With Built-in EtherCAT Communications Models R88M-K□ (AC Servomotors)/R88D-KN□-ECT-R (AC Servo Drives) User's Manual	I573-E1
	OMNUC G5 Series AC Servomotors/Servo Drives With Built-in EtherCAT Communications Models R88M-K□ (AC Servomotors)/R88D-KN□-ECT (AC Servo Drives) User's Manual	I576-E1
	OMNUC G5 Series AC Servomotors/Servo Drives With Built-in EtherCAT Communications Models R88L-□ (Linear Servomotors)/R88D-KN□-ECT-L (AC Servo Drives) User's Manual	I577-E1
	OMNUC G Series Models R88M-G□ (AC Servomotors)/Models R88D-GT□ (AC Servo Drives) AC Servomotors/Servo Drives User's Manual	I562-E1
	OMNUC G Series AC Servomotors/Servo Drives with Built-in MECHATROLINK-II Communications Models R88M-G□ (AC Servomotors)/R88D-GN□-ML2 (AC Servo Drives) User's Manual	I566-E1
	SMARTSTEP A Series Servomotors/Servo Drives Models R7M-A□ (Servomotors)/R7D-AP□ (Servo Drives) User's Manual	I533-E1
	OMNUC W Series Models R88M-W□ (AC Servomotors)/Models R88D-WT□ (AC Servo Drives) AC Servomotors/Servo Drives User's Manual	I531-E1
	OMNUC W Series AC Servomotors/Servo Drives with Built-in MECHATROLINK-II Communications Models R88M-W□ (AC Servomotors)/R88D-WN□-ML2 (AC Servo Drives) User's Manual	I544-E1

For installing procedures of CX-Drive standalone product WS02-DRVC1, refer to the Product Guide in the package.

For details on procedures for installing the CX-Drive from the CX-One FA Integrated Tool Package, refer to the *CX-One Setup Manual* (W463) provided with CX-One.

Cat. No.	Model	Name	Contents
W463	CXONE-□□□□C-V□/□□□□D-V□	CX-One FA Integrated Tool Package Setup Manual	Installation and overview of CX-One FA Integrated Tool Package.

Precautions provides general precautions for using the CX-Drive, Programmable Controller, and related devices.

Section 1 provides an overview of the CX-Drive, and describes the functions and system requirements required to operate the CX-Drive. It also provided installation methods and the overall procedure for using the CX-Drive.

provides basic operating procedures for using the CX-Drive, including descriptions of CX-Drive windows and parameter setting procedures.

Also refer to the *CX-Drive Online Help* for operating procedures and functions. Select **Help** from the Help Menu or click the  Button to display context help, which displays help about the currently displayed window.

Version Improvements

Addition of Supported Drives

Support for the following Inverters has been added for version 1.12 of the CX-Drive:
3G3RV Inverters, Version 1 (-V1)

To specify the 3G3RV-V1 offline with CX-Drive version 1.3, select "3G3RV" in the *Drive Type* dialog box (see page 30) and then specify "V1" in the specification field.

Ver.1.61 supports

OMNUC G series R88D-GT servo drives and SMARTSTEP2 series servo drives.
Data Trace function improvements.

Ver.1.62 supports

OMNUC G series R88D-GN servo drives.

Ver.1.70 supports

3G3JX/MX/RX Inverters.

Ver.1.80 supports

OMNUC G5 Series R88D-KT servo drives.
FFT Analysis function

Ver.1.90 supports

3G3MX2 Inverters.

Ver.1.91 supports

OMNUC G5 Series R88D-KN Servo Drives with Built-in MECHATROLINK-II Communications

Ver.1.92 supports

OMNUC G5 Series R88D-KN with Built-in EtherCAT Communications

Ver.2.10 supports

3G3AX-MX2-ECT EtherCAT Communications Unit for 3G3MX2 inverters.

Ver.2.20 supports

3G3AX-MX2-DRT DeviceNet Communications Unit for 3G3MX2 inverters.

Ver.2.60 supports

3G3RX-V1 inverters, 3G3AX-MX2-CRT-E CompoNet communications option board for 3G3MX2 inverters, 3G3AX-RX-DRT-E DeviceNet communications option board for 3G3RX inverters, and 3G3AX-RX-CRT-E CompoNet communications option board for 3G3RX inverters.

Ver. 2.70 supports

OMNUC G5 Series R88D-KN with Built-in EtherCAT Communications Linear Motor Type, 3G3AX-RX-ECT EtherCAT communications option board for 3G3RX-V1 inverters.

Ver. 2.80 supports

3G3MX2-V1 inverters.

Ver. 2.90 supports

Added motor types in Motor Setup function.

Change to Relative Path Information for Workspace Files (Extension .sdw)

Item	Ver. 1.12	Ver. 1.3
Workspace files (file name extension .sdw)	Link information is held using absolute paths for all drive data files (.sdd). This prevents moving files.	Link information is held using relative paths for all drive data files (.sdd). This enables moving files as long as the relative position of all drive data files is the same.

Support for Windows Vista

CX-Drive version 1.4 or higher will run on Windows Vista.

Support for Windows 7

CX-Drive version 1.91 or higher will run on Windows 7.

Registered Trademark

- MECHATROLINK is a registered trademark of the MECHATROLINK Members Association.
- EtherCAT® is registered trademark and patented technology, licensed by Beckhoff Automation GmbH, Germany.

Terms and Conditions Agreement

Please read and understand this manual before purchasing the products. Please consult your OMRON representative if you have any questions or comments.

1. WARRANTY

- (1) The warranty period for the Software is one year from either the date of purchase or the date on which the Software is delivered to the specified location, unless otherwise specifically agreed.
- (2) If the User discovers defect of the Software (substantial non-conformity with the manual), and return it to OMRON within the above warranty period, OMRON will replace the Software without charge by offering media or download from OMRON's website. And if the User discovers defect of media which is attributable to OMRON and return it to OMRON within the above warranty period, OMRON will replace defective media without charge. If OMRON is unable to replace defective media or correct the Software, the liability of OMRON and the User's remedy shall be limited to the refund of the license fee paid to OMRON for the Software.

2. LIMITATION OF LIABILITY

- (1) THE ABOVE WARRANTY SHALL CONSTITUTE THE USER'S SOLE AND EXCLUSIVE REMEDIES AGAINST OMRON AND THERE ARE NO OTHER WARRANTIES, EXPRESSED OR IMPLIED, INCLUDING BUT NOT LIMITED TO, WARRANTY OF MERCHANTABILITY OR FITNESS FOR PARTICULAR PURPOSE. IN NO EVENT, OMRON WILL BE LIABLE FOR ANY LOST PROFITS OR OTHER INDIRECT, INCIDENTAL, SPECIAL OR CONSEQUENTIAL DAMAGES ARISING OUT OF USE OF THE SOFTWARE.
- (2) OMRON SHALL HAVE NO LIABILITY FOR DEFECT OF THE SOFTWARE BASED ON MODIFICATION OR ALTERNATION TO THE SOFTWARE BY THE USER OR ANY THIRD PARTY.
- (3) OMRON SHALL HAVE NO LIABILITY FOR SOFTWARE DEVELOPED BY THE USER OR ANY THIRD PARTY BASED ON THE SOFTWARE OR ANY CONSEQUENCE THEREOF.

3. APPLICABLE CONDITIONS

USER SHALL NOT USE THE SOFTWARE FOR THE PURPOSE THAT IS NOT PROVIDED IN THE ATTACHED USER MANUAL.

4. CHANGE IN SPECIFICATION

The software specifications and accessories may be changed at any time based on improvements and other reasons.

5. EXTENT OF SERVICE

The license fee of the Software does not include service costs, such as dispatching technical staff.

6. ERRORS AND OMISSIONS

The information in this manual has been carefully checked and is believed to be accurate; however, no responsibility is assumed for clerical, typographical, or proofreading errors, or omissions.

PRECAUTIONS

This section provides general precautions for using the CX-Drive.

The information contained in this section is important for the safe and reliable application of the CX-Drive. You must read this section and understand the information contained before attempting to install or use the CX-Drive.

1	Intended Audience	xvi
2	General Precautions	xvi
3	Safety Precautions	xvi
4	Application Precautions	xvii

1 Intended Audience

This manual is intended for the following personnel, who must also have knowledge of electrical systems (an electrical engineer or the equivalent).

- Personnel in charge of installing FA systems.
- Personnel in charge of designing FA systems.
- Personnel in charge of managing FA systems and facilities.

2 General Precautions

The user must operate the product according to the performance specifications described in the operation manuals.

Before using the product under conditions which are not described in the manual or applying the product to nuclear control systems, railroad systems, aviation systems, vehicles, combustion systems, medical equipment, amusement machines, safety equipment, and other systems, machines, and equipment that may have a serious influence on lives and property if used improperly, consult your OMRON representative.

Make sure that the ratings and performance characteristics of the product are sufficient for the systems, machines, and equipment, and be sure to provide the systems, machines, and equipment with double safety mechanisms.

This manual provides information for programming and operating the Unit. Be sure to read this manual before attempting to use the Unit and keep this manual close at hand for reference during operation.



WARNING

It is extremely important that the CX-Drive and related devices be used for the specified purpose and under the specified conditions, especially in applications that can directly or indirectly affect human life. You must consult with your OMRON representative before applying CX-Drive and related devices to the above-mentioned applications.

3 Safety Precautions



Caution

It may become impossible to stop motor rotation if serial communications fail during test runs. Always provide an external hardware means of stopping the motor.



Caution

Confirm safety at the destination node before transferring parameters or other data to another node from the CX-Drive. Doing either of these without confirming safety may result in injury.



Caution

Always confirm the axis number carefully before starting operation from the CX-Drive.



Caution

Stop the inverter "RUN" when connecting CX-Drive to X-Series inverters during Frequency Reference Selection(A001) is Operator. The motor speed is affected.



Caution

The CS1W-CIF31 Serial Conversion Cable cannot be used to connect a computer running the CX-Drive to the 3G3MV. (See the following note.)

Note USB-Serial Conversion Cables That Can Be Used

For 3G3JV- and 3G3RV-series Inverters: CS1W-CIF31 USB-Serial Conversion Cable.

(The commercially available products listed below can also be used.)

For 3G3MV-series Inverters: The CS1W-CIF31 cannot be used. Use the commercially available products listed below.

Commercially Available USB-Serial Conversion Cables

BHS-US01/GP manufactured by Buffalo

USB-CVRS9 manufactured by Sanwa

The commercially available USB-serial converters have been successfully tested for OMRON Inverters but operation may be unstable in some operating environments (mainly depending on the ambient temperature, humidity, and noise). The functions, performance, and reliability of these converters may not be as specified under all possible conditions. Check the warranty information from the manufacturer.

4 Application Precautions

Observe the following precautions when using the CX-Drive.

- Confirm that set parameters operate properly before using them in actual applications.
- Do not turn OFF the power to the Inverter and the Servo Drive while writing to flash memory. In the worst case, doing so may damage the flash memory.
- After replacing an Inverter or Servo Drive, restart operation only after saving the required parameters in the new Inverter or Servo Drive.
- Confirm that no adverse effect will occur in the system before attempting any of the following. Not doing so may result in an unexpected operation.
 - Changing the operating mode of the PLC (including changing the Startup Mode)
 - Changing parameter settings
 - Automatically downloading parameters (This function is enable by selecting the *Autodownload when a parameter is updated* Option on the Online Options Tab Page in the window that appears when **Tools - Options** is selected from the menu bar.)
- Do not turn OFF the power to the computer while installing or uninstalling the CX-Drive. Doing so may result in corrupted data in the computer.
- The multi-turn counter and alarms will be reset in the absolute serial encoder if the absolute encoder setting function is performed. If the absolute encoder's multi-turn counter is reset to zero, the coordinate system of the mechanical system will change from what it was previously. Be sure that the encoder is set correctly before resetting the mechanical system to the zero point.
- The load will move back and forward during auto tune operation. Please consider what are the conditions you can stop this operation at anytime.
- The motor speed will have extreme variations during FFT analysis operation and Linear System Auto Setup in linear motor setup function. Please consider what are the conditions you can stop this operation at anytime.

- The motor responsive will change during damping control operation. Please consider what are the conditions you can stop this operation any-time.
- Confirm that converted parameters operate properly before using them in actual applications.
- It is not possible to stop the program if a communication error occurs by any chance when program is under execution. The motor can be surely stopped using the outside hardware.

SECTION 1

Overview

This section provides an overview of the CX-Drive, and describes the functions and system requirements required to operate the CX-Drive. It also provided installation methods and the overall procedure for using the CX-Drive.

1-1	Introduction	2
1-2	Installation	6
1-3	System Configuration	7

1-1 Introduction

1-1-1 What Is the CX-Drive?

The CX-Drive is a software application that enables 1) setting, downloading, uploading, and comparing parameters, 2) test runs and tuning, and 3) monitoring and data tracing for Inverters and Servos.

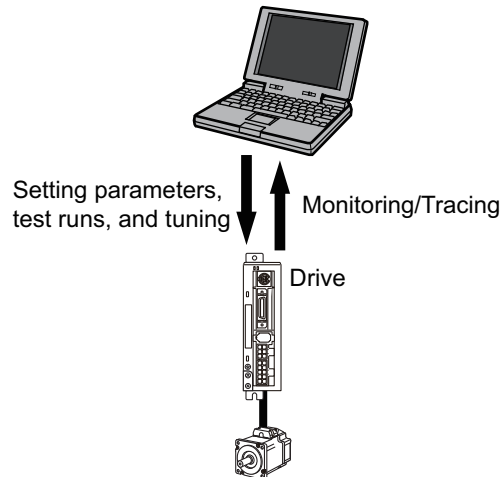

1-1-2 Features

Supports Most OMRON Inverters and Servos

The CX-Drive can be used with OMRON's 3G3JX, 3G3MX, 3G3MX2, 3G3RX, 3G3JV, 3G3MV, and 3G3RV Inverters, as well as OMRON's SMARTSTEP2, SMARTSTEP, OMNUC G5-series, OMNUC G-series, OMNUC W-series Servo Drives.

Wide Range of Parameter Editing Functions

Easy and Dependable Parameter Editing for Inverters and Servos

Inverter and Servo parameters can be edited using parameter numbers or by category. Parameter editing tables show parameter ID numbers, descriptions, units, default values, and ranges in the same way as in the Servo manuals. Parameters can be set using pull-down menus or by typing in settings.

Parameter settings can be easily reviewed because setting status (e.g., modified, warning, default, or disabled) is shown for each parameter to avoid setting mistakes.

Easily Check Drive Parameters and Upload/Download Only Selected Parameters

When connected online, you can easily display drive parameters by using a comparison function. Also, the selected parameters can be downloaded to or uploaded from the drive as required.

Edit Parameters in Graphic Form

Inverter parameters, such as V/F profiles and jump frequencies, can be displayed in graphic charts.

Display Parameters in Diagrams

Drive parameters can be displayed in diagrams, such as PID diagrams or position/speed/torque block diagrams.

Automatically Detect Drives

The connected drives can be detected automatically and displayed in a list without setting model numbers or connection types. Just select a drive to add it to the Workspace.

Inverter Tuning and Test Runs

Auto-tuning for the 3G3RV Just enter the specified motor parameters and let the Servo automatically tune itself to match the characteristics of the motor.

Inverter Test Runs The test run options enable the acceleration, deceleration, and frequency references of the motor to be determined for testing purposes. Additional options allow the motor to be run continuously or cycled for 'n' number of cycles. Forward or reverse operation and stopping are also possible, and the feedback input can be displayed.

The parameters can be set either by entering them directly into the appropriate fields or graphically by dragging handles in the Test Run Setup Diagram.

Servo Tuning and Test Runs

Auto-tuning The auto-tuning function calculates the load moment of inertia during operation of the Servo and sets parameters to achieve Servo gains that are consistent with the machine rigidity settings. These parameters can be saved in the Servo and used the next time power is turned ON.

Servo Test Runs The test run options enable the jog speed, acceleration, and deceleration of the motor to be determined for testing purposes. Continuous operation, cyclic operation, origin searches, turning the Servo ON/OFF, forward/reverse direction selection, stopping, and speed display are also possible.

The parameters can be set either by entering them directly into the appropriate fields or graphically by dragging handles in the Test Run Setup Diagram.

Adjust Offsets for the R7D-AP and R88D-WT The speed/torque offset can be adjusted automatically or manually, the offset and gain of the analog monitor output can be adjusted, and the current detection offset can be adjusted automatically or manually.

Absolute Encoder Setting for the R88D-WT An absolute encoder and multi-turn limit can be set for the R88D-WT.

Damping Control for the R88D-KT and R88D-KN The low-frequency vibration when the motor starts/ stops can be reduced.

Motor Setup for the R88D-KN The suitable values for certain parameters can be set to move linear motor by the wizard.

Realtime Tracing

The Real Time Monitor Window enables monitoring a specific set of parameters. The parameter values are displayed simultaneously in graphic and digital forms.

The graphic display shows the parameter values per unit time.

Note Online functions are supported for only one axis at a time.

1-1-3 Applicable Drives and Communications

The CX-Drive supports the following drives and communications.

Drive type	Series	Communications				
		Serial communications	DeviceNet	MECHATRO-LINK-II	EtherCAT	CompoNet
Inverters	3G3JX	Supported.	---	---	---	---
	3G3MX	Supported.	---	---	---	---
	3G3RX	Supported.	Supported. *1	---	Supported. *2	Supported. *3
	3G3MX2	Supported. *4	Supported. *5	---	Supported. *6	Supported. *7
	3G3JV	Supported. *8	---	---	---	---
	3G3MV	Supported. *9	Supported. *10	---	---	---
	3G3RV (including version-1 models)	Supported. *9	Supported. *11	---	---	---
Servos	SMARTSTEP2 Series (R7D-BP)	Supported. *12	---	---	---	---
	OMNUC G5 Series (R88D-KT)	Supported. *13	---	---	---	---
	OMNUC G5 Series with MECHATROLINK-II (R88D-KN)	Supported. *13	---	---	---	---
	OMNUC G5 Series with EtherCAT (R88D-KN)	Supported. *13	---	---	Supported.	---
	OMNUC G5 Series with EtherCAT Linear Motor Type (R88D-KN (Linear))	Supported. *13	---	---	Supported.	---
	OMNUC G Series (R88D-GT)	Supported. *12	---	---	---	---
	OMNUC G Series with MECHATROLINK-II (R88D-GN)	Supported. *12	---	---	---	---
	SMARTSTEP A Series (R7D-AP)	Supported. *12	---	---	---	---
	OMNUC W Series (R88D-WT)	Supported. *12	---	Supported. *14	---	---
	OMNUC W Series with MECHATROLINK-II (R88D-WN)	---	---	Supported.	---	---

*1. DeviceNet Communications Unit (3G3AX-RX-DRT-E) required.

*2. EtherCAT Communications Unit (3G3AX-RX-ECT) required.

*3. CompoNet Communications Unit (3G3AX-RX-CRT-E) required.

*4. USB: Modbus-RTU protocol.

*5. DeviceNet Communications Unit (3G3AX-MX2-DRT) required.

*6. EtherCAT Communications Unit (3G3AX-MX2-ECT) required.

*7. CompoNet Communications Unit (3G3AX-MX2-CRT-E) required.

*8. RS-232C Communications Unit (3G3JV-PSI232JC) or RS-422/485 Communications Unit (3G3JV-PSI485J) required. Uses Modbus-RTU protocol.

*9. RS-422A/485: Modbus-RTU protocol.

*10. DeviceNet Communications Unit (3G3MV-PDRT2) required. Work online when motor operation is stopped.

*11. DeviceNet Communications Unit (3G3RV-PDRT2) required.

*12. RS-232C: Special protocol.

*13. USB: Special protocol.

*14. MECHATROLINK-II Interface Unit (JUSP-NS115/FNY-NS115) required.

Refer to *1-3 System Configuration* for the system configuration.

1-1-4 Files Created by CX-Drive

The CX-Drive creates the following files.

File type	File name extension	Contents	Saving method
Work-space file	.sdw	Contains the tree for all related drive files. This file contains the relative path name for each data file. Note Relative path information is held, so files can be moved as long as the relative position of all drive data files is the same (CX-Drive Ver. 1.3 or higher).	File - Save Workspace or Save as Workspace...
Drive file	.sdd	Each drive file	File - Save or Save As...
Monitor review file	.sdm	Data of the Real Time Trace or Data Trace.	Select the <i>Save to File Option</i> on the Review Set-up Tab Page in the Real Time Trace or Data Trace Window.
Text file for drive file	.csv or .txt	Each drive file	File - Export

Note Consecutive parameters can be exported to Microsoft Excel via the clipboard by selecting the required parameters with the mouse or from the keyboard (Shift + Cursor Keys) and then selecting **Edit - Copy** from the menu.

The CX-Drive can import the following data files.

File type	File name extension	Contents	Saving method
Text file	.txt	Drive file	File - Import
WMON data file	.usr		

1-1-5 Computer System Requirements

Refer to the *CX-One Setup Manual* (W463) for the computer system requirements for the CX-Drive.

1-1-6 Confirming Product Contents

Refer to the following manual for the product configuration of the CX-One, which contains the CX-Drive.

Cat. No.	Model number	Manual name	Contents
W463	CXONE-□□□□C-V□/□□□□D-V□	CX-One FA Integrated Tool Package Setup Manual	Provides an overview of the CX-One FA Integrated Tool and installation procedures.

For Computer System Requirements and Product Contents of CX-Drive standalone product WS02-DRVC1, refer to the Product Guide in the package.

1-2 Installation

1-2-1 Required Software

To use the CX-Drive, the software applications listed below must be installed on the same computer.

- CX-Drive
- Communications driver: CX-Server (including CX-Server Driver Management Tool)

CX-Drive Availability

Refer to the following manual for installation procedures for the CX-One Package.

Cat. No.	Model number	Manual name	Contents
W463	CXONE-□□□□C-V□/□□□□D-V□	CX-One FA Integrated Tool Package Setup Manual	Provides an overview of the CX-One FA Integrated Tool and installation procedures.

For installing procedures of CX-Drive standalone product WS02-DRVC1, refer to the Product Guide in the package.

1-3 System Configuration

1-3-1 Inverter Connection

USB direct connection

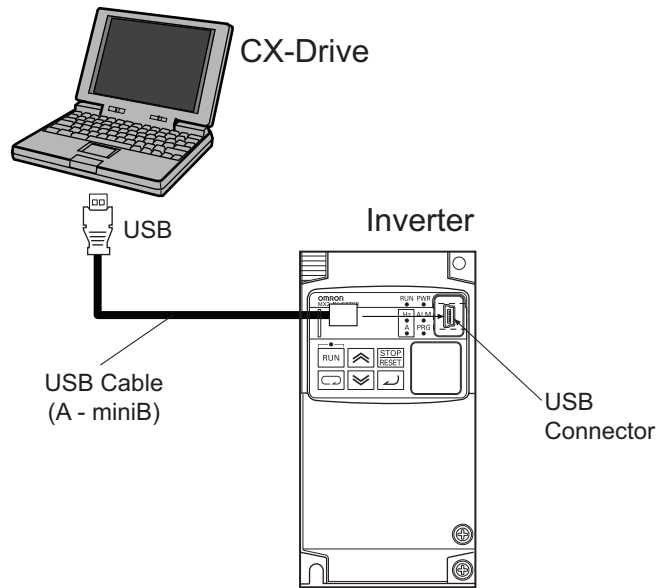

Note Please use a 2m or shorter USB cable.

Direct serial connection

Configuration for 3G3JX/MX/RX

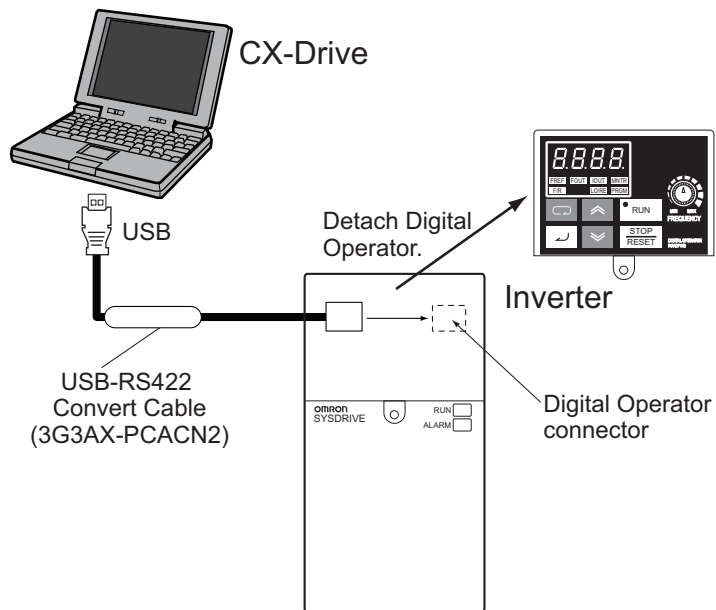

Note 3G3JX/MX/RX

3G3JX : Set parameter C070=02(OPE).

3G3MX/RX : Remove front digital operator panel to connect communication cable.

3G3JX/MX : Turn the RS485/OPE switch to OPE side.

USB-RS422 convert cable for PC-3G3JX/MX/RX connection is 3G3AX-PCACN2.

Refer to following figure to connect general purpose USB-RS422 convert cable in the market to 3G3JX/MX/RX connector.

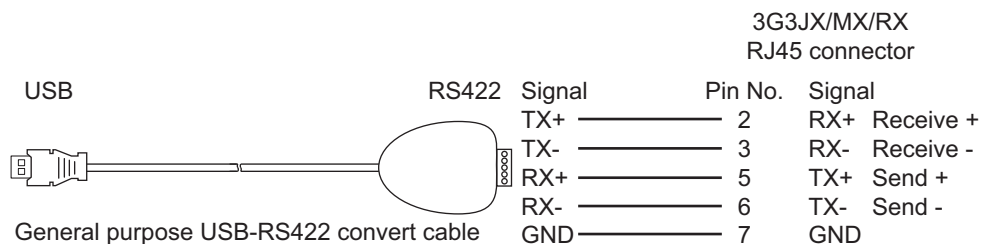

Configuration for 3G3JV/MV/RV

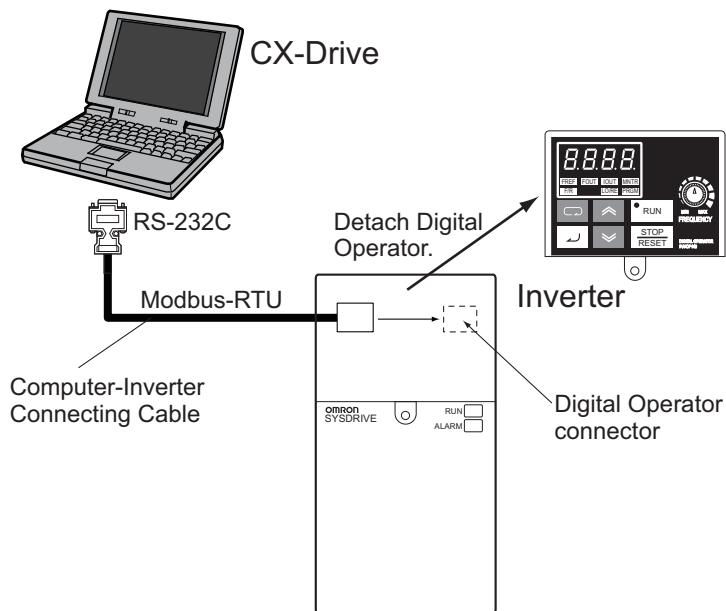

Required devices

Model	Required Devices
3G3JX	USB - RS422 Convert Cable (3G3AX-PCACN2)
3G3MX	
3G3RX	
3G3JV	3G3IV-PWV103 Computer-Inverter Connecting Cable and 3G3JV-PSI232JC RS-232C Communications Unit
3G3MV *1	3G3IV-PWV103 Computer-Inverter Connecting Cable
3G3RV (-V1) *1	

*1.Remove the Digital Operator from the Inverter and connect the cable to the Digital Operator connector.

! Caution

The CS1W-CIF31 Serial Conversion Cable cannot be used to connect a computer running the CX-Drive to the 3G3MV. (See the following note.).

Note USB-Serial Conversion Cables That Can Be Used

For 3G3JV- and 3G3RV-series Inverters: CS1W-CIF31 USB-Serial Conversion Cable.

(The commercially available products listed below can also be used.)

For 3G3MV-series Inverters: The CS1W-CIF31 cannot be used. Use the commercially available products listed below.

Commercially Available USB-Serial Conversion Cables

BHS-US01/GP manufactured by Buffalo

USB-CVRS9 manufactured by Sanwa

The commercially available USB-serial converters have been successfully tested for OMRON Inverters but operation may be unstable in some operating environments (mainly depending on the ambient temperature, humidity, and noise). The functions, performance, and reliability of these converters may not be as specified under all possible conditions. Check the warranty information from the manufacturer.

**PLC Serial
Communications Unit
/ Board connection**

Configuration

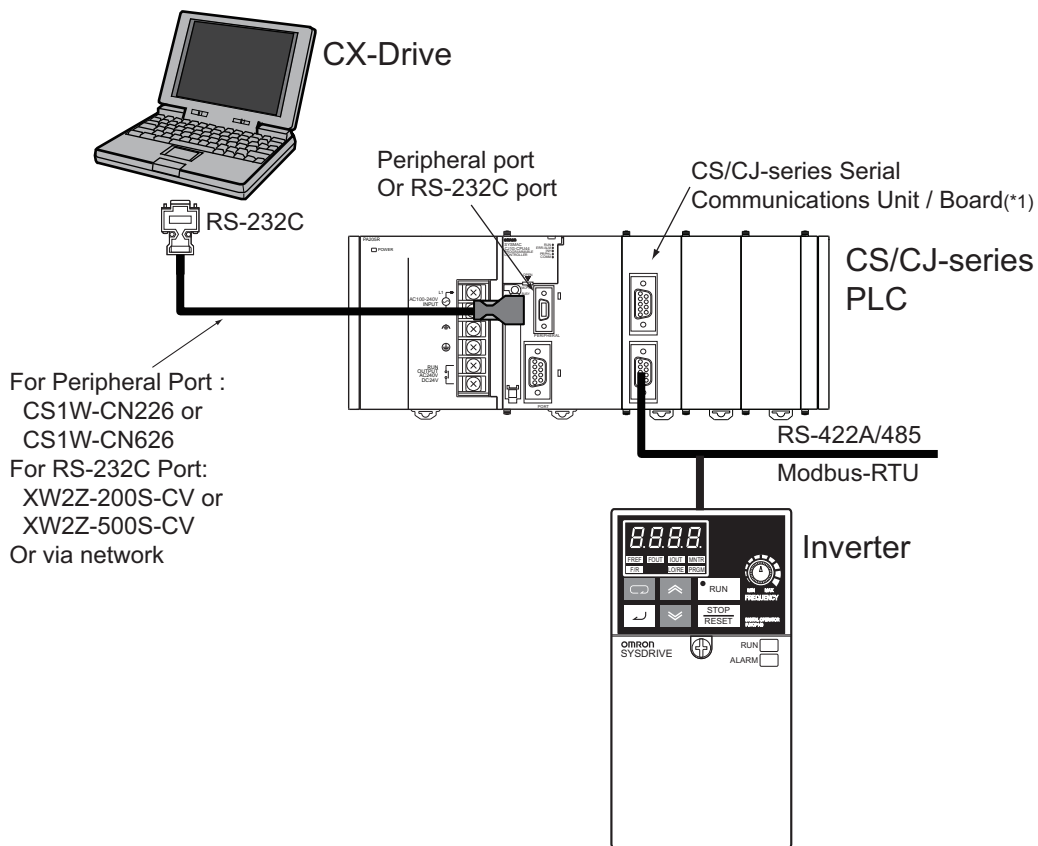

*1. CS/CJ-series Serial Communications Board/Unit Ver. 1.2 or later.

Required devices

Model	Required Devices
3G3JV	3G3JV-PSI485J RS-422/485 Communications Unit
3G3MV	RS-422/485 communications are built into the Inverter.
3G3RV (-V1)	

Note The Serial Gateway Mode is used as the serial communications mode for the RS-422A/485 port.

USB-Serial Conversion Cables That Can Be Used

For 3G3JV- and 3G3RV-series Inverters: CS1W-CIF31 USB-Serial Conversion Cable.

PLC DeviceNet connection

Configuration

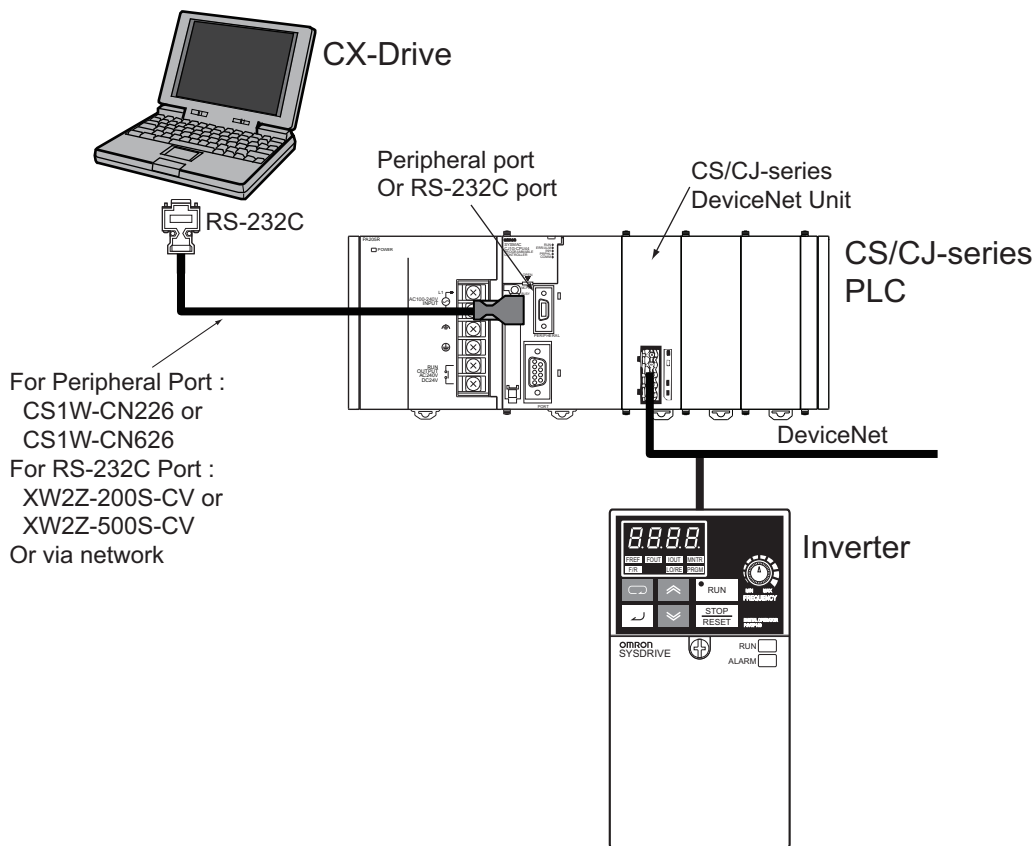

Required devices

Model	Required Devices
3G3JV	---*1
3G3MV	3G3MV-PDRT2 DeviceNet Communications Unit*2
3G3RV (-V1)	3G3RV-PDRT2 DeviceNet Communications Card
3G3RX	3G3AX-RX-DRT-E DeviceNet Communications Unit
3G3MX2	3G3AX-MX2-DRT DeviceNet Communications Card

*1.DeviceNet connection is not available.

*2.Work online when motor operation is stopped.

PLC CompoNet connection

Configuration

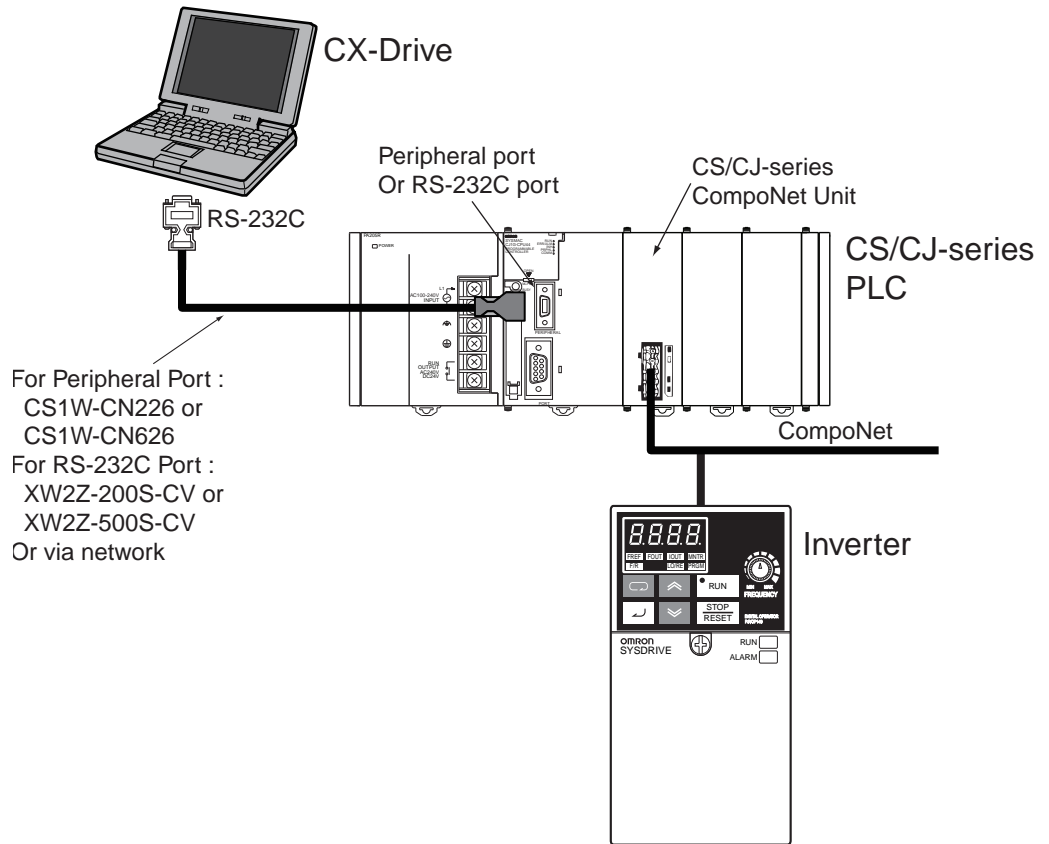

Required devices

Model	Required Devices
3G3RX	3G3AX-RX-CRT-E CompoNet Communications Unit
3G3MX2	3G3AX-MX2-CRT-E CompoNet Communications Card

1-3-2 Servo Connection

USB direct connection

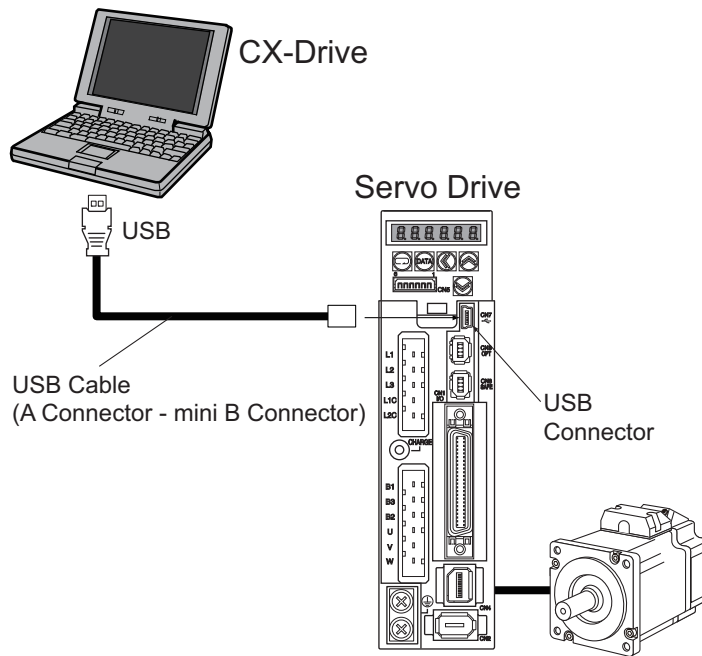

Required devices

Model	Required Devices
R88D-KT	USB cable (A Connector - mini B Connector)
R88D-KN	

Note Please use a 2m or shorter USB cable.

Direct serial connection

Configuration

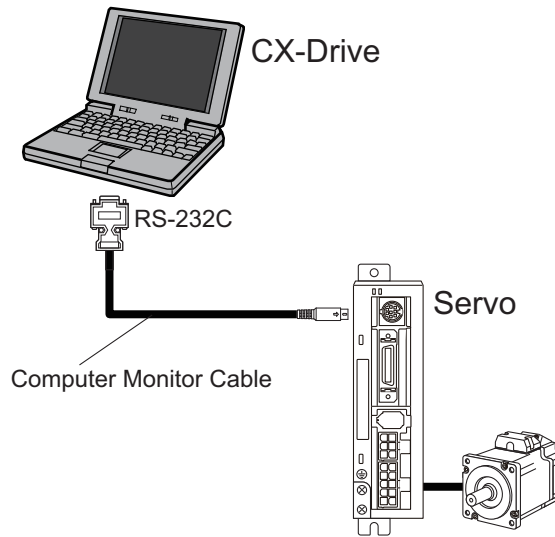

Required devices

Model	Required Devices
SMARTSTEP2 Series (R7D-BP)	R88A-CCG002P2 Computer Monitor Cable
OMNUC G Series (R88D-GT) ^{*1}	
OMNUC G Series (R88D-GN)	
SMARTSTEP A Series (R7D-AP)	R7A-CCA002P2 Computer Monitor Cable
OMNUC W Series (R88D-WT)	R88A-CCW002P2 Computer Monitor Cable
OMNUC W Series (R88D-WN)	--- ^{*2}

*1.R88D-GT Serial port for Computer is CN3B.

Multiple R88D-GT can be connected with R88A-CCG001P4 or R88A-CCG0R5P4 (first drive No. 0's CN3A to next drive No. n's CN3B, and so on) and one Computer can be online to another R88D-GT through these connections.

*2.Direct serial connection is not available.

PLC Serial Communications Unit / Board connection

With Servo Relay Unit to Control Servo

• **Configuration**

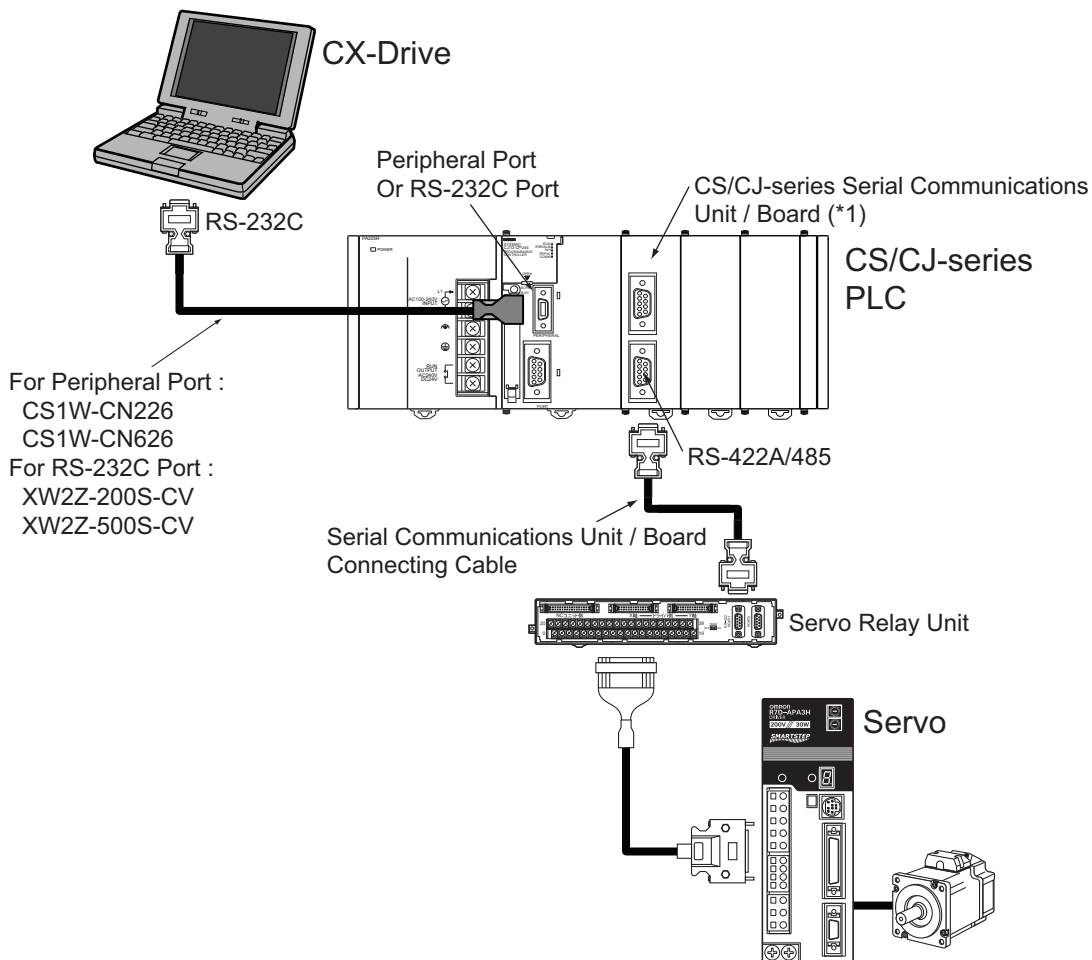

*1. CS/CJ-series Serial Communications Unit / Board Ver. 1.2 or later

- **Required devices**

Model	Required Devices
SMARTSTEP2 Series (R7D-BP)	---*1
OMNUC G Series (R88D-GT)	---*1
OMNUC G Series (R88D-GN)	---*1
SMARTSTEP A Series (R7D-AP)	XW2Z-□□□J-CJ Serial Communications Unit / Board Connecting Cable + XW2B-40J6-4A Servo Relay Unit + XW2Z-□□□J-B7 SMARTSTEP A-series Connecting Cable.
OMNUC W Series (R88D-WT)	XW2Z-□□□J-CJ Serial Communications Unit / Board Connecting Cable + XW2B-40J6-4A Servo Relay Unit + XW2Z-□□□J-B8 OMNUC W-series Connecting Cable.
OMNUC W Series (R88D-WN)	---*2

*1. Serial communication via PLC is not available.

*2. Serial communication is not available.

Note The Serial Gateway Mode is used as the serial communications mode for the RS-232C port.

Without Servo Relay Unit

• **Configuration**

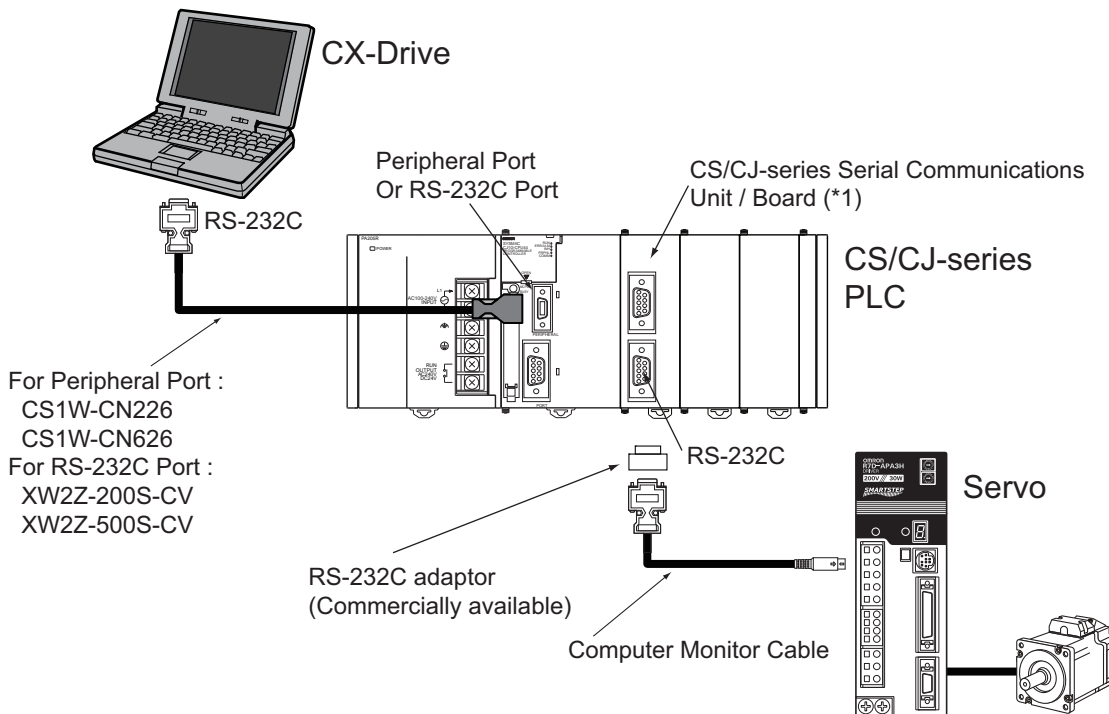

• **Required devices**

Model	Required Devices
SMARTSTEP2 Series (R7D-BP)	---*1
OMNUC G Series (R88D-GT)	---*1
OMNUC G Series (R88D-GN)	---*1
SMARTSTEP A Series (R7D-AP)	R7A-CCA002P2 (2 m) + RS-232C 9-pin adaptor
OMNUC W Series (R88D-WT)	R88A-CCW002P2 (2 m) + RS-232C 9-pin adaptor
OMNUC W Series (R88D-WN)	---*2

*1. Serial communication via PLC is not available.
*2. Serial communication is not available.

Note The Serial Gateway Mode is used as the serial communications mode for the RS-232C port.

**PLC (MCH / NCF Unit)
MECHATROLINK-II
connection**

Configuration

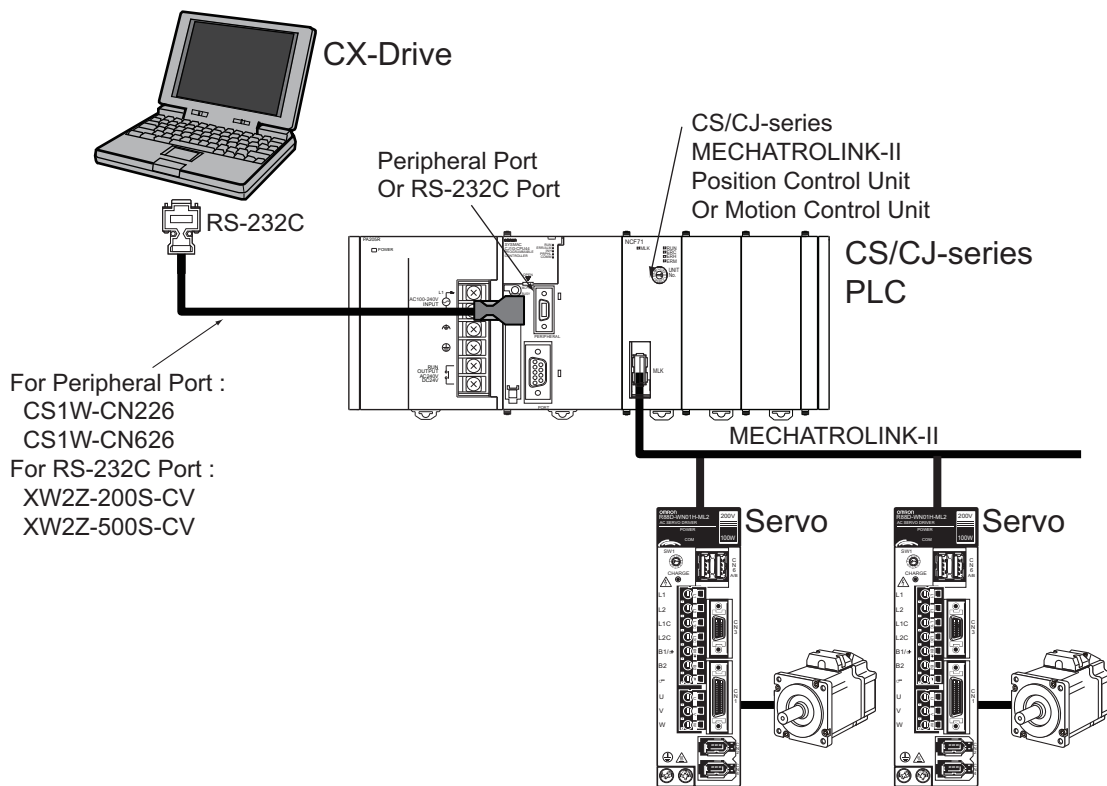

Required devices

Model	Required Devices
SMARTSTEP2 Series (R7D-BP)	---*1
OMNUC G Series (R88D-GT)	---*1
OMNUC G Series (R88D-GN)	---*2
SMARTSTEP A Series (R7D-AP)	---*1
OMNUC W Series (R88D-WT)	MECHATROLINK-II Cable MECHATROLINK-II Interface Unit (FNY-NS115)
OMNUC W Series (R88D-WN)	MECHATROLINK-II Cable

*1.MECHATROLINK-II communication via PLC is not available.
*2.CX-Drive does not support R88D-GN MECHATROLINK-II connection.
Controller support tool (CX-Motion-NCF) can be used.

PLC EtherCAT connection

Configuration

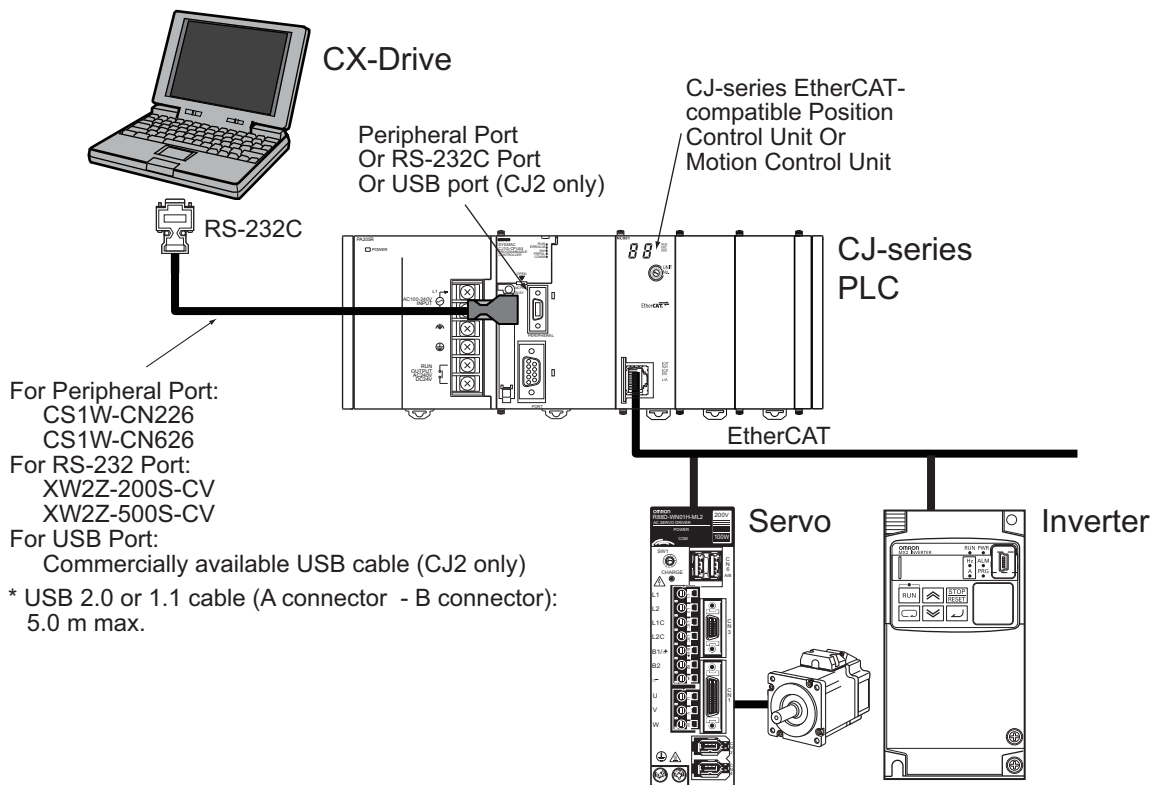

Required devices

Model	Required Devices
OMNUC G5 Series (R88D-KN□□□-ECT)	Ethernet cable
3G3MX2	EtherCAT Communications Unit (3G3AX-MX2-ECT)
3G3RX-V1	EtherCAT Communications Unit (3G3AX-RX-ECT)

SECTION 2

Basic Operations

This section provides basic operating procedures for using the CX-Drive, including descriptions of CX-Drive windows and parameter setting procedures.

- 2-1 Overall Operating Procedure 22
- 2-2 Starting the CX-Drive 26
- 2-3 Creating New Drive Files 27
- 2-4 User Interface 39
- 2-5 Editing Drive Files 49

2-1 Overall Operating Procedure

2-1-1 Inverters

- 1,2,3...
1. **Install the software.**
 - Install the CX-Server and CX-Drive from the CX-One.
 - Refer to the *CX-One Setup Manual* (Cat. No. W463).
 - Follow the setup display about CX-One Autoupdate or CX-Drive stand-alone install.
 2. **Connect the drive to the computer.**
 - Connect the CX-Drive (computer) to the drive (Inverter or Servo) using one of the system configurations.
 - Refer to *1-3 System Configuration*
 3. **Start the CX-Drive.**
 - Select **Program - OMRON - CX-One - CX-Drive - CX-Drive** from the Windows Start Menu.
 4. **Create a new drive file.**
 - Detect the drives connected online automatically and create drive file for the desired drive.
Select **File - Autodetect** from the menu bar.
 - Create a new drive file on the computer without a drive.
 - a. Select **File - New** from the menu bar and then select the drive type in the New Drive Dialog Box.
Select *Inverter* as the drive type and then select one of the following series.
 - 3G3JX
 - 3G3MX
 - 3G3RX (For version 1 of the 3G3RX, click the **Settings** Button and select **-V1** for the **Specification**.)
 - 3G3MX2
 - 3G3JV
 - 3G3MV
 - 3G3RV (For version 1 of the 3G3RV, click the **Settings** Button and select **-V1** for the **Specification**.)
 - b. Select the connection type in the New Drive Dialog Box.

Connection Types	Connection
Via PLC (DeviceNet)	PLC DeviceNet connection
Via PLC (CompoNet)	PLC CompoNet connection
Via PLC (SCU/SCB)	PLC Serial Communications Unit / Board connection
Via PLC (NC□8□/ EtherCAT)	PLC EtherCAT connection
Direct	Direct USB/ serial connection

5. **Edit the parameters.**
 - Edit the parameters for the Inverter.
 - In the Workspace, double-click **Parameter edit** and then the required categories in the drive file.
 - Edit parameters in numeric order or by functional category.
6. **Connect online to the drive.**
 - Select **Drive - Work Online** from the menu bar.
7. **Transfer and verify the parameters.**
 - Select **Drive - Transfer - To drive** from the menu bar.
8. **Tune and test operation.**
 - Test Run
Double-click **Test Run** in the Workspace.
Perform the following:
Forward / Reverse operation, stopping, frequency references, acceleration / deceleration, S-curve display, and dwelling.
 - Auto Tune (3G3RV only)
Double-click **Auto Tune** in the Workspace.
Enter the motor parameters, perform auto-tuning, and then save the new parameters.
9. **Monitor operation.**
 - Perform a Real Time Trace.
Double-click **Real Time Trace** in the Workspace.
 - Check the status.
Double-click **Status** in the Workspace.
10. **Save the data.**
 - Save the Workspace and/or the drive file.
 - Select **File - Save Workspace**, or **select File - Save as Workspace...**

2-1-2 Servo

- 1,2,3...
1. **Install the software.**
 - Install the CX-Server and CX-Drive from the CX-One.
 - Refer to the *CX-One Setup Manual* (Cat. No. W463).
 - Follow the setup display about CX-One Autoupdate or CX-Drive stand-alone install.
 2. **Connect the drive to the computer.**
 - Connect the CX-Drive (computer) to the drive (Inverter or Servo) using one of the system configurations.
 - Refer to *1-3 System Configuration*
 3. **Start the CX-Drive.**
 - Select **Program - OMRON - CX-One - CX-Drive - CX-Drive** from the Windows Start Menu.
 4. **Create a new drive file.**
 - Detect the drives connected online automatically and create drive file for the desired drive.
Select **File - Autodetect** from the menu bar.
 - Create a new drive file on the computer without a drive.
 - c. Select **File - New** from the menu bar and then select the drive type in the New Drive Dialog Box.
Select *Servo* as the drive type and then select one of the following series.

Model	Series Name
R7D-BP	SMARTSTEP 2 Series
R88D-GT	OMNUC G Series
R88D-GN	OMNUC G Series with MECHATROLINK-II
R88D-KT	OMNUC G5 Series
R88D-KN	OMNUC G5 Series with MECHATROLINK-II OMNUC G5 Series with EtherCAT
R7D-AP	SMARTSTEP A Series
R7D-ZN	SMARTSTEP Junior with MECHATROLINK-II
R88D-WT	OMNUC W Series
R88D-WN	OMNUC W Series with MECHATROLINK-II

- d. Select the connection type in the New Drive Dialog Box.

Connection Types	Connection
Via PLC (MCH / MECHATROLINK-II)	MECHATROLINK-II connection Motion Control Unit
Via PLC (NCF / MECHATROLINK-II)	MECHATROLINK-II connection Position Control Unit
Via PLC (SCU/SCB)	PLC Serial Communications Unit / Board connection
Via PLC (NC□8□/ EtherCAT)	PLC EtherCAT connection
Direct	Direct USB/ serial connection

5. **Edit the parameters.**
 - Edit the parameters for the Servo.
 - In the Workspace, double-click **Parameter edit** and then the required categories in the drive file.
 - Edit parameters in numeric order or by functional category.
6. **Connect online to the drive.**
 - Select **Drive - Work Online** from the menu bar.
7. **Transfer and verify the parameters.**
 - Select **Drive - Transfer - To drive** from the menu bar.
8. **Tune and test operation.**
 - Test Run (R88D-KT, R88D-KN, R88D-GT, R88D-GN, R7D-AP, R88D-WT)
Double-click **Test Run** in the Workspace.
Perform the following: Jogging, origin searches, forward/reverse operation, stopping, and speed control.
 - Auto Tune (R7D-BP, R88D-KT, R88D-KN, R88D-GT, R88D-GN, R7D-AP, R88D-WT)
Double-click **Auto Tune** in the Workspace.
The auto-tuning function calculates the load moment of inertia during Servo operation and sets parameters to achieve Servo gains that are consistent with the machine rigidity settings.
 - Offset (R7D-AP, R88D-WT)
Double-click **Offset** in the Workspace.
The speed/torque offset can be adjusted automatically or manually, the offset and gain of the analog monitor output can be adjusted, and the current detection offset can be adjusted automatically or manually.
 - Absolute Encoder Setting (R88D-GT, R88D-WT)
Double-click **Absolute Encoder** in the Workspace.
An absolute encoder and multi-turn limit can be set.
 - FFT (R7D-BP, R88D-KT, R88D-KN, R88D-GT, R88D-GN)
Double-click **FFT** in the Workspace.
The FFT analysis can be performed.
9. **Monitor operation.**
 - Perform a Real Time Trace. (R7D-AP or R88D-WT only)
Double-click **Real Time Trace** in the Workspace.
 - Check the status.
Double-click **Status** in the Workspace.
10. **Save the data.**
 - Save the Workspace and/or the drive file.
 - Select **File - Save Workspace**, or **select File - Save as Workspace...**

2-2 Starting the CX-Drive

Select **Program - OMRON - CX-One - CX-Drive - CX-Drive** from the Windows Start Menu to start the CX-Drive. (The path depends on where the CX-Drive was installed.)

Note When using the 3G3MV or 3G3RV as a DeviceNet slave, right-click the Inverter on the CX-Integrator network configuration, and select **Start special application - Start with Settings Inherited** from the pop-up menu.

The following window will be displayed when the CX-Drive starts.

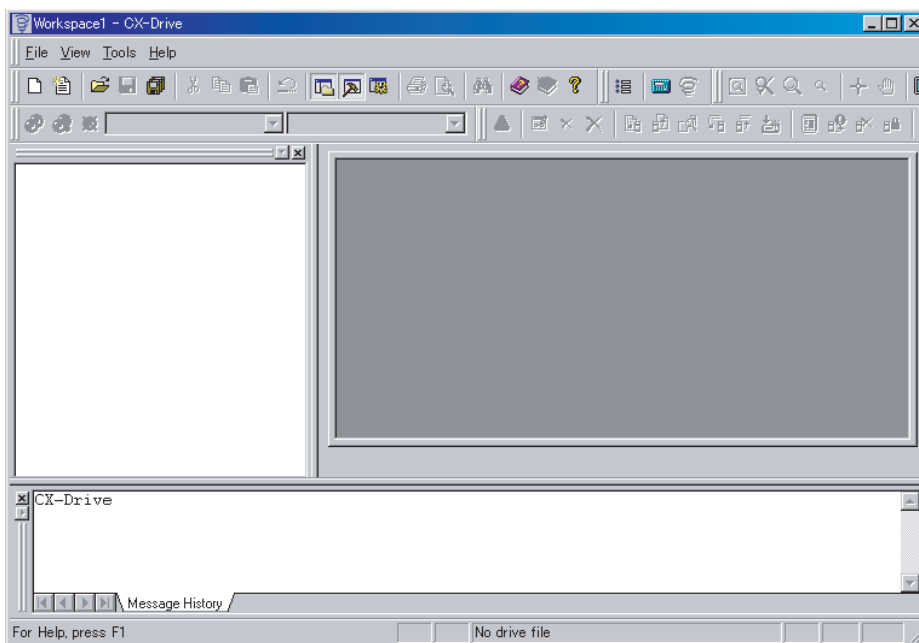

2-3 Creating New Drive Files

There are two methods to create a new drive file in the Workspace.

Method 1: Go online and automatically detect the connected drives to create the drive file.

Method 2: Create a new data file without using a connected drive.

2-3-1 Method 1: Automatically Detecting the Connected Drives

Serial Direct Connection

- 1,2,3... 1. Select **Drive - Autodetect Options**.

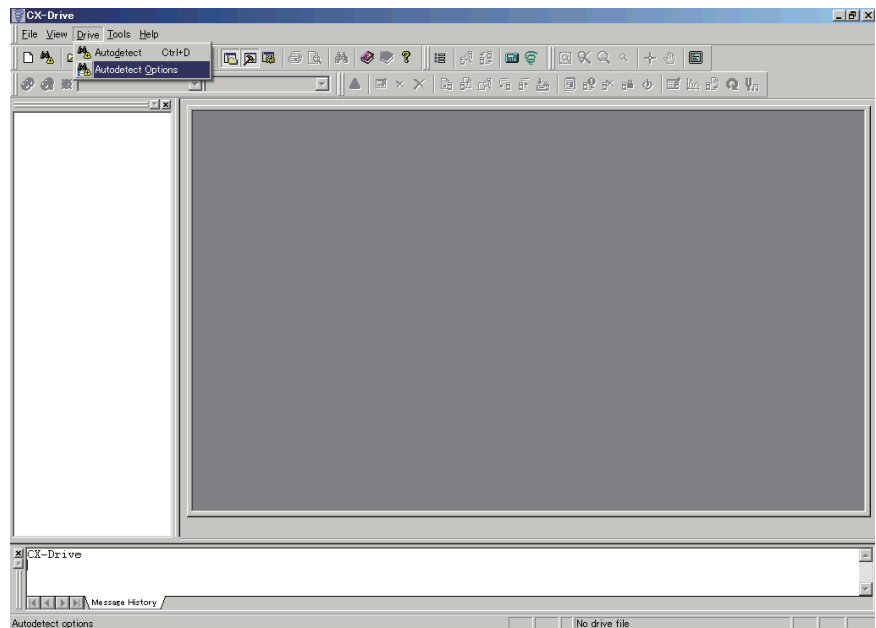

2. Select the target within known scope.
This dialogue is the same with **Tool Option menu, Autodetect tab**.

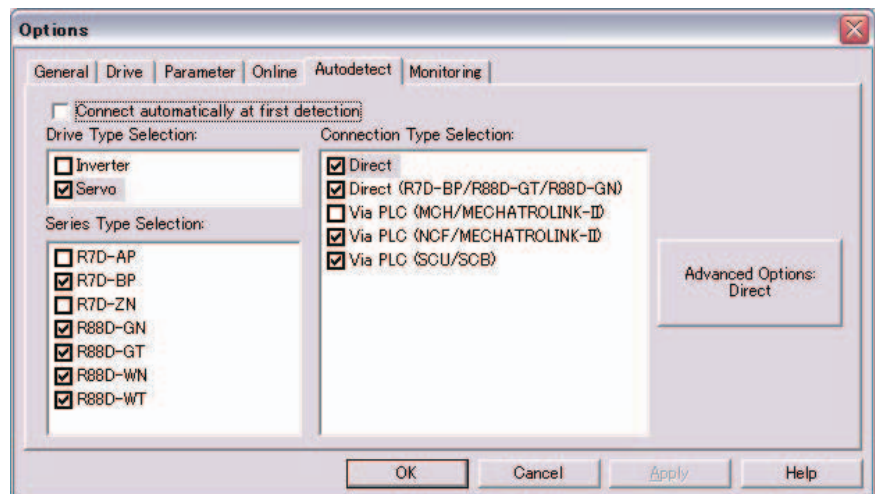

3. Push **Advanced Options** button, and select further settings.

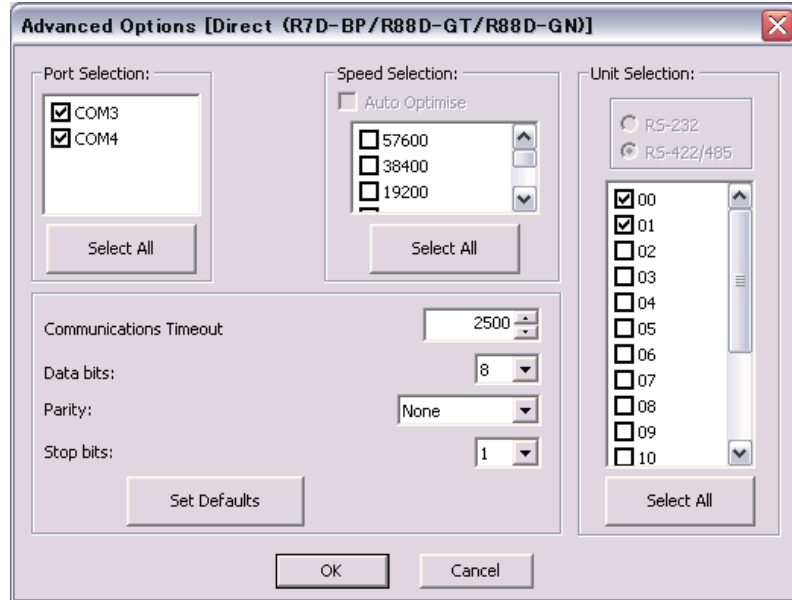

4. Select **Drive-Autodetect menu**.
CX-Drive searches selected targets in option settings, and creates the drive data for detected target.

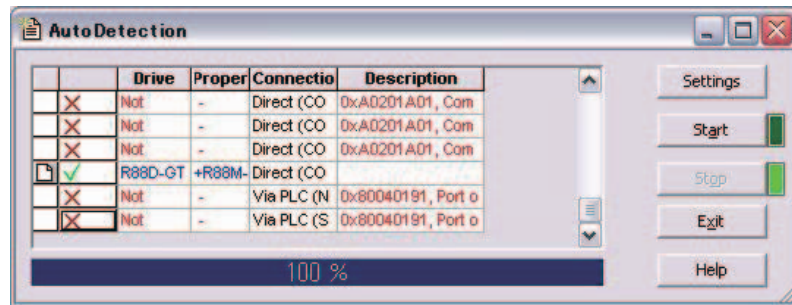

Other Connections

- 1,2,3... 1. Select **Drive- Autodetect Option**.
 "via PLC" can be selected besides the Serial Direct Connections.

For Inverters:

- Via PLC (DeviceNet)
- Via PLC (CompoNet)
- Via PLC (SCU/SCB)
- Via PLC (NC□8□/ EtherCAT)

For Servos:

- Via PLC (MCH/MECHATROLINK II)
- Via PLC (NC□71/MECHATROLINK II)
- Via PLC (SCU/ SCB)
- Via PLC (NC□8□/ EtherCAT)

2. Push **Advanced Options** and select settings.

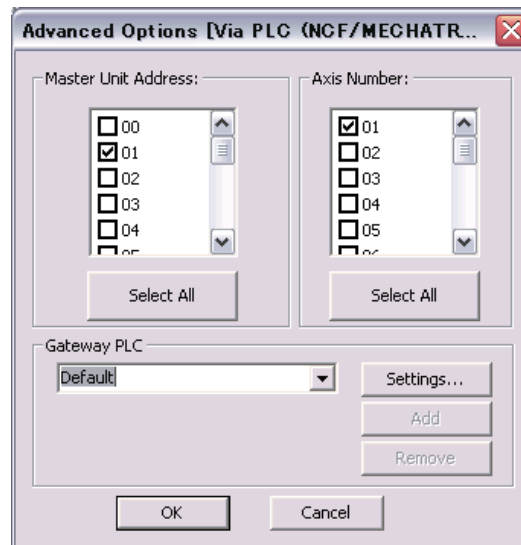

3. Select **Drive - Autodetect**.
 4. The rest of the procedure is the same as Serial Direct Connection.

2-3-2 Method 2: Creating a New Data File without a Connected Drive

Select **File - New**. The following New Drive Dialog Box will be displayed.

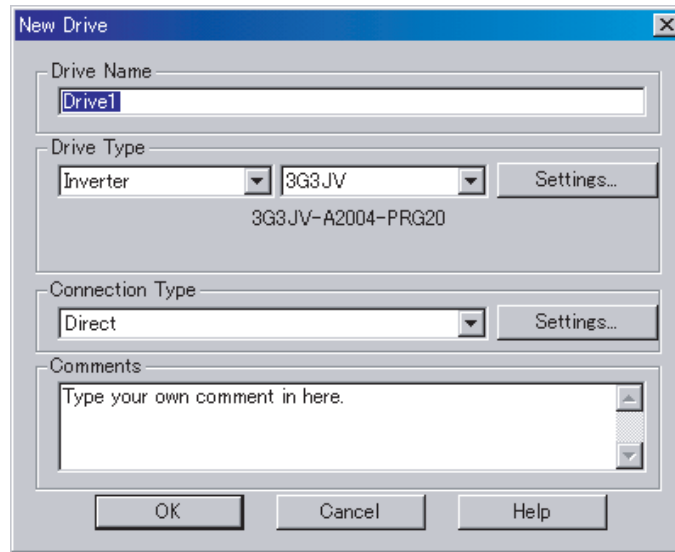

Drive Name

Any name may be input for the drive name. The default name is “Drive” plus a sequential number.

Drive Type

Drive Type Selection

Select *Inverter* or *Servo*.

Drive Type Name

For an Inverter, select one of the following series from the pull-down list.

- 3G3JX
- 3G3MX
- 3G3RX (See note.)
- 3G3MX2
- 3G3JV
- 3G3MV
- 3G3RV (See note.)

Note For version 1 of the 3G3RX, select 3G3RX, click the **Settings** Button and select **-V1** from the **Specification** pull-down list.

Note For version 1 of the 3G3RV, select 3G3RV, click the **Settings** Button and select **-V1** from the **Specification** pull-down list.

For a Servo, select one of the following series from the pull-down list.

- R7D-BP: SMARTSTEP2 Series
- R88D-GT: OMNUC G Series
- R88D-GN: MECHATROLINK-II OMNUC G Series
- R88D-KT: OMNUC G5 Series
- R88D-KN: MECHATROLINK-II OMNUC G5 Series
EtherCAT OMNUC G5 Series
EtherCAT OMNUC G5 Series Linear Motor Type
- R7D-AP: SMARTSTEP A Series
- R88D-WT: OMNUC W Series
- R88D-WN: MECHATROLINK-II OMNUC W Series

Detailed Drive Settings

Click the **Settings...** Button to open the Detail Setting Dialog Box.

Inverters

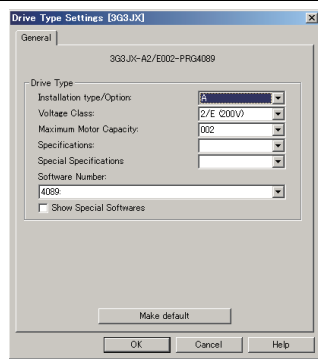
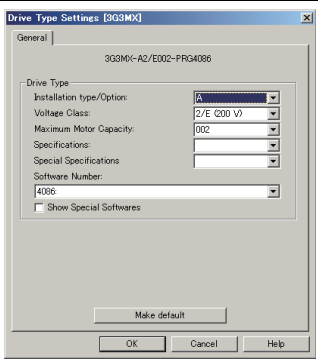
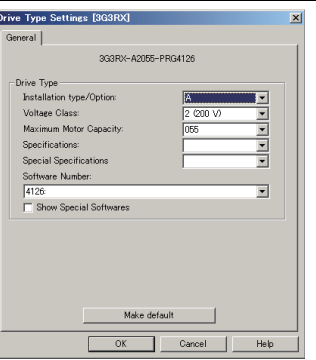
Inverter Series		3G3JX	3G3MX	3G3RX
Dialog box				
Drive Type	Installation Type/Option	A	A	A
	Voltage Class	2/E	2/E, 4	2, 4
	Maximum Motor Capacity	002, 004, 007, 015, 022, 037	002, 004, 007, 015, 022, 037, 055, 075	004, 007, 015, 022, 037, 055, 075, 110, 150, 185, 220, 300, 370, 550
	Specifications	---	---	None or V1
Options	Option Board	---	---	3G3AX-RX-ECT 3G3AX-RX-CRT 3G3AX-RX-DRT

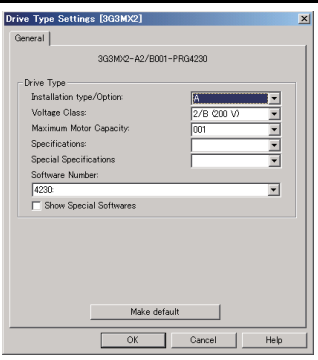
Inverter Series		3G3MX2
Dialog box		
Drive Type	Installation Type/Option	A
	Voltage Class	2/B, 4
	Maximum Motor Capacity	001, 002, 004, 007, 015, 022, 030, 037, 040, 055, 075, 110, 150
	Specifications	---
Options	Option Board	3G3AX-MX2-ECT 3G3AX-MX2-CRT 3G3AX-MX2-DRT

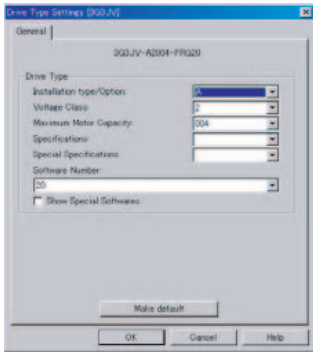
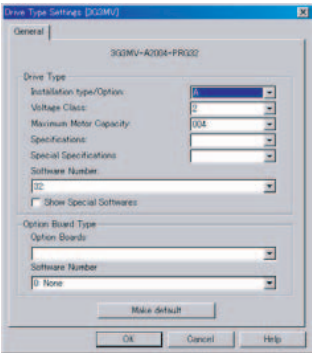
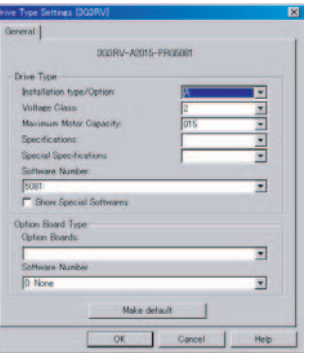
Inverter Series		3G3JV	3G3MV	3G3RV
Dialog box				
Drive Type	Installation Type/Option	A	A, X	A, B, X
	Voltage Class	1, 2, 4, B	2, 4, B	2, 4
	Maximum Motor Capacity	001, 002, 004, 007, 015, 022, 037	001, 002, 004, 007, 015, 022, 037, 040, 055, 075	004, 007, 015, 022, 037, 055, 075, 110, 150, 185
	Specifications	---	---	None or V1
Options	Option Board	---	3G3MV-PDRT2	3G3RV-PDRT2

Servos

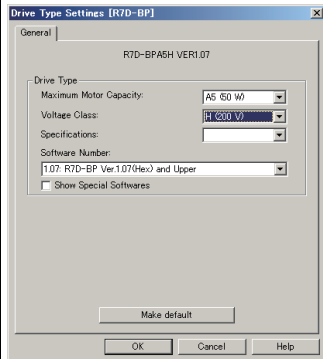
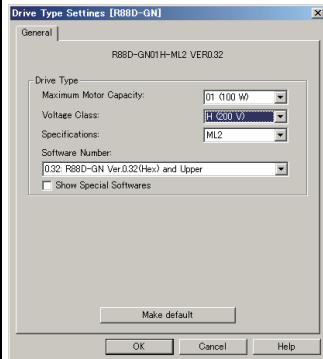
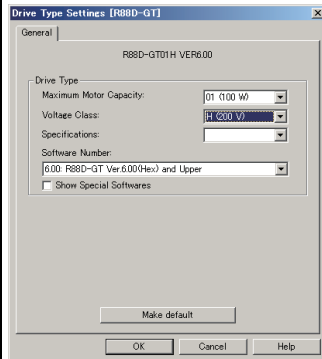
Servo Series		R7D-BP	R88D-GT	R88D-GN
Dialog box				
Drive Type	Maximum Motor Capacity	A5 (50 W) to 04 (400 W)	01 (100 W) to 75 (7.5 kW)	01 (100 W) to 75 (7.5 kW)
	Voltage Class	H (200 V), HH(200V), L (100 V)	H (200 V), L (100 V)	H (200 V), L (100 V)
	Specifications	---	---	MECHATROLINK-II (ML2)

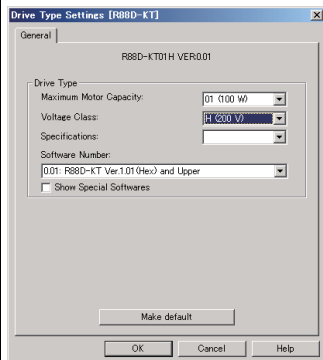
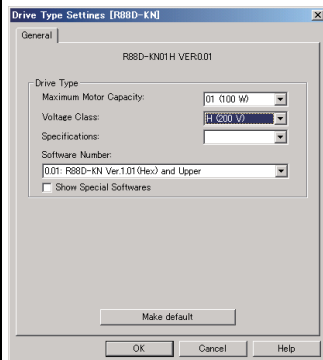
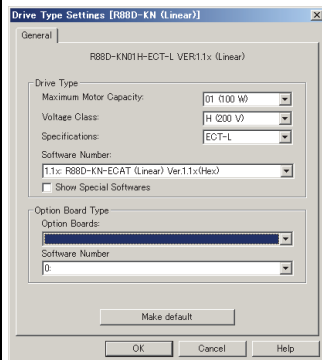
Servo Series		R88D-KT	R88D-KN	R88D-KN (Linear)
Dialog box				
Drive Type	Maximum Motor Capacity	A5(50W) to 50(5kW)	A5(50W) to 150(15kW)	01(100 W) to 150(15 kW)
	Voltage Class	H(200V), L(100V), F(400V)	H(200V), L(100V), F(400V)	H(200V), L(100V), F(400V)
	Specifications	---	MECHATROLINK-II (ML2) EtherCAT (ECT)	EtherCAT (ECT)

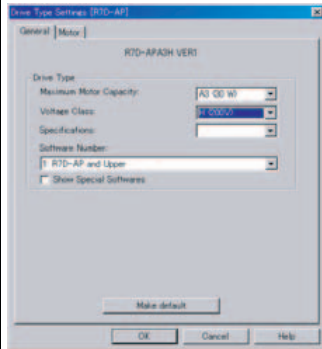
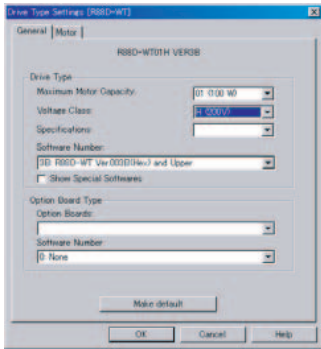
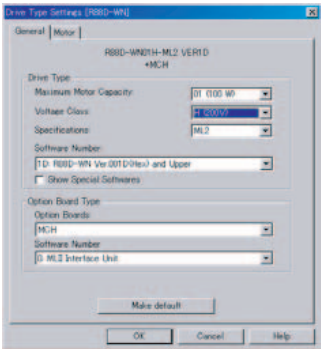
Servo Series		R7D-AP	R88D-WT	R88D-WN
Dialog box				
Drive Type	Maximum Motor Capacity	A3 (30 W) to 08 (750 W)	A3 (30 W) to 150 (15 kW)	A5 (50 W) to 30 (3 kW)
	Voltage Class	H (200 V), L (100 V)	H (200 V), HF (400 V), HH (200 V), HL (150 V)	H (200 V), L (100 V)
	Specifications	---	---	MECHATROLINK-II (ML2)

Connection Type

Connection Type Selection

Select one of the following connection types for the *Connection Type*.

Inverters

Selection	Connection type	Inverter Series			
		3G3JX	3G3MX	3G3RX	3G3MX2
Direct	Direct USB Connection	Not supported.	Not supported.	Not supported.	Supported.
	Direct Serial Connection	Supported.	Supported.	Supported.	Not supported.
Via PLC (SCU/ SCB)	PLC Serial Communications Unit / Board Connection	Not supported.	Not supported.	Not supported.	Not supported.
Via PLC (DeviceNet)	PLC DeviceNet Connection	Not supported.	Not supported.	Not supported.	Supported.
Via PLC (CompoNet)	PLC CompoNet Connection	Not supported.	Not supported.	Supported.	Supported.
Via PLC (NC□8□/ EtherCAT)	PLC EtherCAT Connection	Not supported.	Not supported.	Supported.	Supported.

Selection	Connection type	Inverter Series		
		3G3JV	3G3MV	3G3RV
Direct	Direct USB Connection	Not supported.	Not supported.	Not supported.
	Direct Serial Connection	Supported.	Supported.	Supported.
Via PLC (SCU/SCB)	PLC Serial Communications Unit / Board Connection	Supported.	Supported.	Supported.
Via PLC (DeviceNet)	PLC DeviceNet Connection	Not supported.	Supported.	Supported.
Via PLC (CompoNet)	PLC CompoNet Connection	Not supported.	Not supported.	Not supported.
Via PLC (NC□8□/ EtherCAT)	PLC EtherCAT Connection	Not supported.	Not supported.	Not supported.

Servos

Selection	Connection type	Servo Series					
		R7D-BP	R88D-KT	R88D-KN	R88D-KN (Linear)	R88D-GT	R88D-GN
Direct	Direct USB Connection	Not supported.	Supported.	Supported.	Supported.	Not supported.	Not supported.
	Direct Serial Connection	Supported.	Not supported.	Not supported.	Not supported.	Supported.	Supported.
Via PLC (SCU/SCB)	PLC Serial Communications Unit / Board Connection	Not supported.	Not supported.	Not supported.	Not supported.	Not supported.	Not supported.
Via PLC (MCH/ MECHATROLINK-II)	PLC (MCH Unit) MECHATROLINK-II Connection	Not supported.	Not supported.	Not supported.	Not supported.	Not supported.	Not supported.
Via PLC (NC□71/ MECHATROLINK-II)	PLC (NC□71 Unit) MECHATROLINK-II Connection	Not supported.	Not supported.	Not supported.	Not supported.	Not supported.	Not supported.
Via PLC (NC□8□/ EtherCAT)	PLC EtherCAT Connection	Not supported.	Not supported.	Supported.*1	Supported.	Not supported.	Not supported.

*1. Only models with built-in EtherCAT communications.

Selection	Connection type	Servo Series		
		R7D-AP	R88D-WT	R88D-WN
Direct	Direct USB Connection	Not supported.	Not supported.	Not supported.
	Direct Serial Connection	Supported.	Supported.	Not supported.
Via PLC (SCU/ SCB)	PLC Serial communications Unit / Board Connection	Supported.	Supported.	Not supported.
Via PLC (MCH/MECHATROLINK-II)	PLC (MCH Unit) MECHATROLINK-II Connection	Not supported.	Supported with FNY-NS115.	Supported.
Via PLC (NC□71/MECHATROLINK-II)	PLC (NC□71 Unit) MECHATROLINK-II Connection	Not supported.	Supported with FNY-NS115.	Supported.

Network Settings

Click the **Settings...** Button to the right of the *Connection Type* Field. The following dialog box will be displayed.

Detailed Settings for Direct Connections

Item	Network Tab Page	Drive Tab Page
Dialog box		
Inverter	<ul style="list-style-type: none"> • Slave Unit Address: 1 to 32 (Modbus-RTU slave address) (See note 1.) • Communications Timeout: 500 to 5,000 ms • Number of retries: 1 to 6 	<ul style="list-style-type: none"> • Port Selection: COM1, COM2, etc. • Baud Rate: 2400, 9600, 19200, or 38400 bits/s • Parity: None, Odd, or Even • Data bits: 7 or 8 • Stop bits: 1 or 2
Servo	<ul style="list-style-type: none"> • Slave Unit Address: 0 to F (Servo Drive communications Unit No.) (See note 2.) • Communications Timeout: 500 to 5,000 ms • Number of retries: 1 to 6 	<ul style="list-style-type: none"> • Port Selection: COM1, COM2, etc. • Baud Rate: 9600 or 19200 bits/s • Parity: None, Odd, or Even • Data bits: 7 or 8 • Stop bits: 1 or 2

Note (1) Modbus-RTU Slave Address Setting:
The Modbus-RTU slave address (01 to 32) is set in the following parameter using the Digital Operator on front of the Inverter before connecting the CX-Drive.

Inverter Series	3G3JV	3G3MV	3G3RV
Parameter No.	n70	n153	H5-01

(2) The Servo Communications Unit No. (0 to F) is set using the following method before connecting the CX-Drive.

Servo Series	R7D-AP	R88D-WT
Method	Unit number rotary switch on the Servo	Change to the Setting Mode using the Servo front panel settings and set the unit number in digit 2 of Pn000.

Via PLC (SCU/SCB) Connections (Except R88D-WN)

Item	Network Tab Page	Gateway PLC Tab Page
Dialog box		
Inverter	<ul style="list-style-type: none"> • Slave Unit Address: 1 to 32 (Modbus-RTU slave address) (See note 1.) • Master Unit Address: 0 to 15 (Unit address for Serial Communications Unit). Or select <i>CS-Series Inner Board</i> Option (Serial Communications Board). • Port Selection: Port 1 or Port 2 	Click the Properties Button to set the PLC (with a Serial Communications Unit/Board) to use as the gateway.
Servo	<ul style="list-style-type: none"> • Slave Unit Address: 0 to F (Servo Communications Unit No.) (See note 2.) • Master Unit Address: 0 to 15 (Unit Address for Serial Communications Unit). Or select <i>CS-Series Inner Board</i> Option (Serial Communications Board). • Port Selection: Port 1 or Port 2 	

Note (1) Modbus-RTU Slave Address Setting:
The Modbus-RTU slave address (01 to 32) is set in the following parameter using the Digital Operator on front of the Inverter before connecting the CX-Drive.

Inverter Series	3G3JV	3G3MV	3G3RV
Parameter No.	n70	n153	H5-01

(2) The Servo Communications Unit No. (0 to F) is set using the following method before connecting the CX-Drive.

Servo Series	R7D-AP	R88D-WT
Method	Unit number rotary switch on the Servo	Change to the Setting Mode using the Servo front panel settings and set the unit number in digit 2 of Pn000.

Via PLC (DeviceNet) Connections or Via PLC (CompoNet) Connections (3G3MV, 3G3RV)

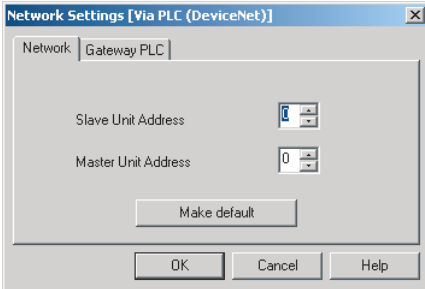
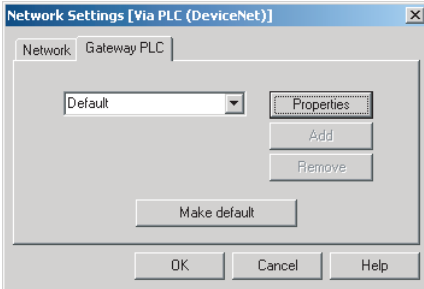
Item	Network Tab Page	Gateway PLC Tab Page
Dialog box		
Inverter	<ul style="list-style-type: none"> • Slave Unit Address: 0 to 63 (DeviceNet or CompoNet slave address) • Master Unit Address: 0 to 15 (DeviceNet or CompoNet unit number) 	<p>Click the Properties Button to set the PLC (with a DeviceNet or CompoNet Unit) to use as the gateway.</p>

Via PLC (MCH/MECHATROLINK-II) or Via PLC (NC□71/MECHATROLINK-II) (R88D-WN) or Via PLC (NC□8□/EtherCAT)(R88D-KN)

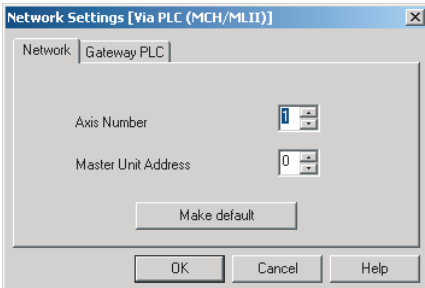
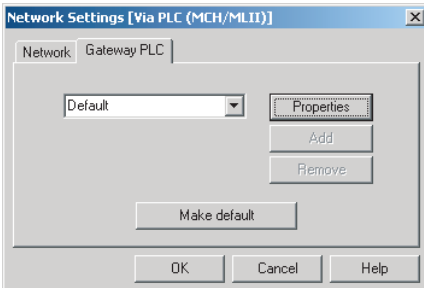
Item	Network Tab Page	Gateway PLC Tab Page
Dialog box		
Inverter	<ul style="list-style-type: none"> • Slave Unit Address: 1 to 80 (See Note). • Master Unit Address: 0 to 15 	<p>Click the Properties Button to set the PLC (with a MCH or NC Unit) to use as the gateway.</p>
Servo	<ul style="list-style-type: none"> • Axis Number: 1 to 32 for MCH or 1 to 16 for NC□71 • Master Unit Address: 0 to 15 (MCH or NC unit number) 	

Note Depending on the model of the NC Unit to be mounted, some numbers are not available. Refer to the manuals of the NC Unit for details.

2-4 User Interface

2-4-1 Window Structure

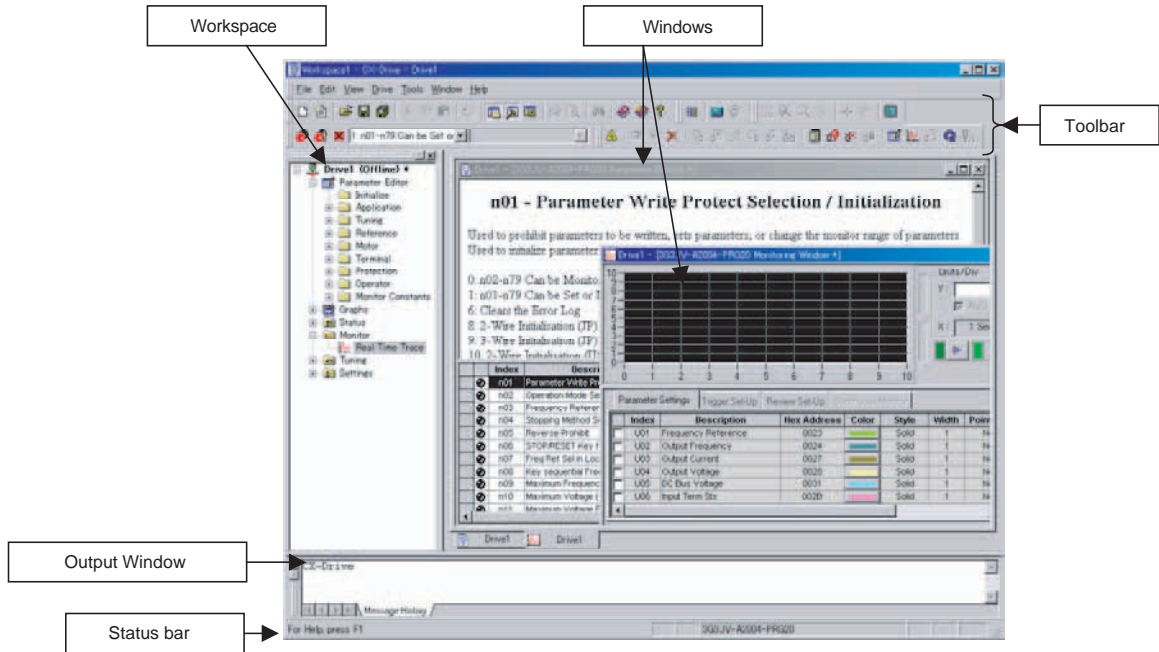

2-4-2 Functions

Functions Table

Folder	Contents
Parameter Editor	Edits the parameters of Inverters or Servos.
Graphs	Displays parameters graphically.
Diagrams	Displays parameters in block diagrams.
Status	Displays online drive status.
Monitor	Enables realtime traces and other monitoring of online drives.
Tuning	Enables test runs and auto-tuning of online drives.
Settings	Enables initializing online drives.

Functions

Folder	Inverters						
	3G3JX	3G3MX	3G3RX	3G3MX2	3G3JV	3G3MV	3G3RV
Parameter Editor	OK	OK	OK	OK	OK	OK	OK
Graphs	---	---	---	---	OK	OK	OK
Diagrams	---	---	---	---	---	OK	OK
Status	OK	OK	OK	OK	OK	OK	OK
Monitor	OK	OK	OK	OK	OK	OK	OK
Tuning	---	OK	OK	OK	OK	OK	OK
Settings	OK	OK	OK	OK	OK	OK	OK

Folder	Servos								
	R7D-BP	R88D-KT	R88D-KN	R88D-KN (Linear)	R88D-GT	R88D-GN	R7D-AP	R88D-WT	R88D-WN
Parameter Editor	OK	OK	OK	OK	OK	OK	OK	OK	OK
Diagrams	OK	---	---	---	OK	OK	---	OK	---
Status	OK	OK	OK	OK	OK	OK	OK	OK (See note.)	---
Monitor	OK	OK	OK	OK	OK	OK	OK	OK (See note.)	---
Motor Setup	---	---	---	OK	---	---	---	OK (See note.)	---
Tuning	OK	OK	OK	OK	OK	OK	OK	---	---
Settings	OK	OK	OK	OK	OK	OK	OK	OK	---

Note These functions are not supported when communicating via MECHATRO-LINK II.

Inverters

Folder	3G3JX	3G3MX	3G3RX
Parameter Editor	<ul style="list-style-type: none"> • Basic Settings • Analog Input • Multi-Step Speed, Jogging • Characteristics, Torque Boost • DC Injection Braking • Upper/Lower Limit, Jump • PID Control • AVR • RUN Mode, Accel/Decel Functions • External Frequency Adjustment • Operation Frequency • Frequency Addition • VR Adjustment • Restart During Momentary Power Interruption • Electronic Thermal • Overload Limit • Frequency Pull-In • Lock • Non-Stop Function at Momentary Power Interruption • Initialization • Multi-Function Input Terminals • Multi-Function Output Setting • Level Output Status Setting • Communication Function Adjustment • Various Adjustment • Control Parameters • Monitor Constants(Fault History/Trace) 	<ul style="list-style-type: none"> • Basic Settings • Analog Input • Multi-Step Speed, Jogging • Characteristics, Torque Boost • DC Injection Braking • Upper/Lower Limit, Jump • PID Control • AVR • RUN Mode, Accel/Decel Functions • External Frequency Adjustment • Operation Frequency • Frequency Addition • VR Adjustment • Restart During Momentary Power Interruption • Electronic Thermal • Overload Limit • Lock • Initialization • Multi-Function Input Terminals • Multi-Function Output Setting • Level Output Status Setting • Communication Function Adjustment • Various Adjustment • Control Parameters • Monitor Constants(Fault History/Trace) 	<ul style="list-style-type: none"> • Basic Settings • Analog Input • Multi-Step Speed, Jogging • Characteristics, Torque Boost • DC Injection Braking • Upper/Lower Limit, Jump • PID Control • AVR • RUN Mode, Accel/Decel Functions • External Frequency Adjustment • Acceleration/Deceleration • Operation Frequency • Restart During Momentary Power Interruption • Electronic Thermal • Overload Limit • Lock • Non-Stop Function at Momentary Power Interruption • Torque Limit • Vf Free Setting • Multi-Function Input Terminals • Multi-Function Output Setting • Analog Monitor • Level Output Status Setting • Communication Function Adjustment • Various Adjustment • Meter Adjustment • Output Terminal Operation Function • Input Terminal Response • Control Parameters • Absolute Position Control • User Parameter • Monitor Constants(Fault History/Trace)
Status	<ul style="list-style-type: none"> • Digital Inputs • Digital Outputs • Inverter Status • Alarms 	<ul style="list-style-type: none"> • Digital Inputs • Digital Outputs • Inverter Status • Alarms 	<ul style="list-style-type: none"> • Digital Inputs • Digital Outputs • Inverter Status • Alarms
Monitor	<ul style="list-style-type: none"> • Real Time Trace 	<ul style="list-style-type: none"> • Real Time Trace 	<ul style="list-style-type: none"> • Real Time Trace
Tuning	---	<ul style="list-style-type: none"> • Test Run 	<ul style="list-style-type: none"> • Test Run
Settings	<ul style="list-style-type: none"> • Initialize 	<ul style="list-style-type: none"> • Initialize 	<ul style="list-style-type: none"> • Initialize

Folder	3G3MX2
Parameter Editor	<ul style="list-style-type: none"> • Fault History • Set-up • Basic Settings • Analog Input • Multi-Step Speed, Jogging • V/f Profile • DC Injection Braking • Limit, Jump • PID Control • AVR • RUN Mode, Accel/Decel Functions • External Frequency Adjustment • Acceleration/Deceleration • Operation Frequency • Restart After Momentary Power Interruption • Electronic Thermal • Overload Limit • Lock • Torque Limit • Controlled Stop Operation at Power Loss • Window Comparator • Vf Free Setting • Password • Multi-Function Input Terminals • Multi-Function Output Terminals • Analog Monitor • Level Output Status Setting • Communication Function • Adjustment • Input/Output Terminals Function • Control Constants • Simple Position Control • Simple Torque Control • Pulse Input • Communication Between Inverters • User Parameter • Others
Graphs	<ul style="list-style-type: none"> • V/f Profile
Status	<ul style="list-style-type: none"> • Digital Inputs • Digital Outputs • Drive Status • Alarms
Monitor	<ul style="list-style-type: none"> • Real Time Trace
Tuning	<ul style="list-style-type: none"> • Test Run
Settings	<ul style="list-style-type: none"> • Initialize

Folder	3G3JV	3G3MV	3G3RV
Parameter Editor	<ul style="list-style-type: none"> • Initialize • Application • Tuning • Reference • Motor • Terminal • Protection • Operator • Monitor Constants 	<ul style="list-style-type: none"> • Initialize • Application • Tuning • Reference • Motor • Options • Terminal • Protection • Operator • Up 2/Down 2 • Monitor Constants 	<ul style="list-style-type: none"> • Initialize • Application • Tuning • Reference • Motor • Options • Terminal • Protection • Special Adjustment • Operator • Motor Auto-tuning • Monitor Constants
Graphs	<ul style="list-style-type: none"> • Analogue Input 1 • Analogue Output 1 • Jump Frequencies • V/F Profile 	<ul style="list-style-type: none"> • Analogue Output 1 • Frequency Reference Input • Jump Frequencies • Multifunction Analogue Current Input • Multifunction Analogue Voltage Input • V/F Profile 	<ul style="list-style-type: none"> • Analogue Input 1 • Analogue Input 2 • Analogue Output 1 • Analogue Output 2 • Jump Frequencies • V/F Profile • V/F Profile Motor 2
Diagrams	---	<ul style="list-style-type: none"> • PID Control Loop • PID Target Value • PID Feedback Value 	<ul style="list-style-type: none"> • PID Control Loop
Status	<ul style="list-style-type: none"> • Digital Inputs • Digital Outputs • Inverter Status 1 • Status Signal • Alarms 	<ul style="list-style-type: none"> • Digital Inputs • Digital Outputs • Inverter Status 1 • Status Signal • Alarms 	<ul style="list-style-type: none"> • Digital Inputs • Digital Outputs • Inverter Status 1 • Status Signal • Alarms
Monitor	<ul style="list-style-type: none"> • Real Time Trace 	<ul style="list-style-type: none"> • Real Time Trace 	<ul style="list-style-type: none"> • Real Time Trace
Tuning	<ul style="list-style-type: none"> • Test Run 	<ul style="list-style-type: none"> • Test Run 	<ul style="list-style-type: none"> • Test Run • Auto-tune
Settings	<ul style="list-style-type: none"> • Initialize 	<ul style="list-style-type: none"> • Initialize 	<ul style="list-style-type: none"> • Initialize • Password Authorization

Servos















Folder	R7D-BP	R88D-GT	R88D-GN
Parameter Editor	<ul style="list-style-type: none"> • Function Selection Parameters • Gain Related Parameters • Position Control Related Parameters • Internal Speed Control Related Parameters • Sequence Related Parameters 	<ul style="list-style-type: none"> • Function Selection Parameters • Gain Related Parameters • Position Control Related Parameters • Speed Control and Torque Control Related Parameters • Sequence Related Parameters 	
Diagrams	<ul style="list-style-type: none"> • Internal Speed Control Mode • Position Control Mode 	<ul style="list-style-type: none"> • Position Control Mode • Speed Control Mode • Torque Control Mode 	
Status	<ul style="list-style-type: none"> • CN1 Input Signal Monitor • CN1 Output Signal Monitor • Drive Status • Load Status • Pulse Status • Alarms 	<ul style="list-style-type: none"> • CN1 Input Signal Monitor • CN1 Output Signal Monitor • Drive Status • Load Status • Pulse Status • Alarms 	
Monitor	<ul style="list-style-type: none"> • Real Time Trace • Data Trace 	<ul style="list-style-type: none"> • Real Time Trace • Data Trace 	
Tuning	<ul style="list-style-type: none"> • Auto Tune 	<ul style="list-style-type: none"> • Test Run • Auto Tune • Absolute Encoder 	
Settings	<ul style="list-style-type: none"> • Initialize • Product Information 	<ul style="list-style-type: none"> • Initialize • Product Information 	























Folder	R88D-KT	R88D-KN	R88D-KN (Linear)
Parameter Editor	<ul style="list-style-type: none"> • Basic Parameters • Gain Parameters • Vibration Suppression Parameters • Analog Control Parameters • I/F Monitor Setting Parameters • Extended Parameters • Special Parameters • Quick Parameter Setup 	<ul style="list-style-type: none"> • CiA402 Drive Profile • Basic Parameters • Gain Parameters • Vibration Suppression Parameters • Analog Control Parameters • I/F Monitor Setting Parameters • Extended Parameters • Special Parameters1 to 3 • Quick Parameter Setup 	<ul style="list-style-type: none"> • CiA402 Drive Profile • Basic Parameters • Gain Parameters • Vibration Suppression Parameters • Analog Control Parameters • I/F Monitor Setting Parameters • Extended Parameters • Special Parameters 1 to 3 • Linear Motor and Encoder Setting Parameters • Quick Parameter Setup
Status	<ul style="list-style-type: none"> • Analog Monitor • Analog Monitor Setting • Drive Status • Input Signal Monitor • Output Signal Monitor • Physical Input Signal • Physical Output Signal • Pulse Status • Rotation Hindering • Status • Warning Data • Alarms 	<ul style="list-style-type: none"> • Analog Monitor • Analog Monitor Setting • Drive Status • Input Signal Monitor • Output Signal Monitor • Physical Input Signal • Physical Output Signal • Pulse Status • Rotation Hindering • Status • Warning Data • Enhancing Input Signal • Alarms 	<ul style="list-style-type: none"> • Analog Monitor • Analog Monitor Setting • Drive Status • Input Signal Monitor • Output Signal Monitor • Physical Input Signal • Physical Output Signal • Pulse Status • Rotation Hindering • Status • Warning Data • Enhancing Input Signal • Alarms
Monitor	<ul style="list-style-type: none"> • Real Time Trace • Data Trace 	<ul style="list-style-type: none"> • Real Time Trace • Data Trace 	<ul style="list-style-type: none"> • Real Time Trace • Data Trace
Motor Setup	---	---	• Linear Motor Setup









Folder	R88D-KT	R88D-KN	R88D-KN (Linear)
Tuning	<ul style="list-style-type: none"> • Test Run • Auto Tune • Offset • Absolute Encoder • FFT • Damping Control 	<ul style="list-style-type: none"> • Test Run • Auto Tune • Absolute Encoder • FFT • Damping Control 	<ul style="list-style-type: none"> • Test Run • Auto Tune • FFT • Damping Control
Settings	<ul style="list-style-type: none"> • Initialize • Product Information 	<ul style="list-style-type: none"> • Initialize • Product Information 	<ul style="list-style-type: none"> • Initialize • Product Information

Folder	R7D-AP	R88D-WT	R88D-WN
Parameter Editor	<ul style="list-style-type: none"> • Function Selection Constants • Gain Related Constants • Position Related Constants • Speed Related Constants • Torque Related Constants • Sequence Related Constants • Other Constants 	<ul style="list-style-type: none"> • Function Selection Constants • Gain Related Constants • Position Related Constants • Speed Related Constants • Torque Related Constants • Sequence Related Constant • Other Constants 	<ul style="list-style-type: none"> • Function Selection Constants • Gain Related Constants • Position Related Constants • Speed Related Constants • Torque Related Constants • Sequence Related Constants • Regenerative Resistor Capacity • Motion Parameters • MECHATROLINK-II Constants
Diagrams	---	<ul style="list-style-type: none"> • Position Block Diagram • Speed Block Diagram • Torque Block Diagram 	---
Status	<ul style="list-style-type: none"> • Input signals • Output signals • Motion Status • Alarms 	<ul style="list-style-type: none"> • Input signals • Output signals • Motion Status • Alarms 	---
Monitor	<ul style="list-style-type: none"> • Real Time Trace • Data Trace 	<ul style="list-style-type: none"> • Real Time Trace • Data Trace 	---
Tuning	<ul style="list-style-type: none"> • Test Run • Auto Tune • Offset 	<ul style="list-style-type: none"> • Test Run • Auto Tune • Offset • Absolute Encoder 	---
Settings	<ul style="list-style-type: none"> • Initialize • Password Authorization • Product Information 	<ul style="list-style-type: none"> • Initialize • Module Detection Clear • Password Authorization • Product Information 	---

2-4-3 Menu Commands

Menu	Submenu/Command	Contents	Inverter	Servo	Icon
File	New	Creates a new drive file.	OK	OK	
	Autodetect	Detect drives automatically.	OK	OK	
	Open	Opens an existing drive file (.sdd), or monitor review file (.sdm).	OK	OK	
	Close	Closes an open drive file (.sdd).	OK	OK	---
	Open Workspace	Opens an existing Workspace (.sdw).	OK	OK	
	Close Workspace	Closes the active Workspace (.sdw).	OK	OK	---
	Save Workspace	Saves the active Workspace (.sdw).	OK	OK	---
	Save as Workspace	Saves the active Workspace with a new name (.sdw).	OK	OK	---
	Save	Saves an open drive file using its existing file name (.sdd).	OK	OK	
	Save As	Saves an open drive file using a specified file name and directory (.sdd).	OK	OK	---
	Save All	Saves all currently open drive files (.sdd).	OK	OK	
	Print	Prints the current drive file.	OK	OK	
	Print Preview	Displays a print preview of the drive file in the active window.	OK	OK	
	Page Setup	Changes printing options, such as margins, include drive information, drive type page heading, etc.	OK	OK	---
	Import	Imports a file from the specified directory.	OK	OK	---
	Export	Exports the current drive file to a file in the specified directory as a CSV or text file.	OK	OK	---
	Recent file	Opens a recent drive file.	OK	OK	---
	Recent Workspace	Opens a recent Workspace.	OK	OK	---
	Exit	Exits the CX-Drive.	OK	OK	---
	Edit	Undo	Undoes the previous editing operation.	OK	OK
Cut		Deletes data from the drive file and places it on the clipboard.	OK	OK	
Copy		Copies data from the drive file and places it on the clipboard.	OK	OK	
Paste		Pastes data from the clipboard into the drive file.	OK	OK	
Delete		Deletes selected data from the drive file.	OK	OK	---
Select All		Selects all the data in the drive file.	OK	OK	---
Find		Searches for a specific item in the drive file.	OK	OK	
View	Tool Bars	Shows or hides the toolbars (Standard, Modes, Drive, View, and Tools).	OK	OK	---
	Status Bar	Shows or hides the status bar for the drive type name and other information.	OK	OK	---
	Workbook Mode	Shows the selected windows with tabs.	OK	OK	---
	Full Screen	Displays the active view in full screen mode.	OK	OK	
	Output	Shows or hides the output window.	OK	OK	

Menu	Submenu/Command	Contents	Inverter	Servo	Icon	
View	Workspace	Shows or hides the Workspace window.	OK	OK	---	
	Motor Management	Shows or hides the motor operation window.	OK	OK		
	Zoom	Zooms in and out using a rectangle, initial setting, etc.	OK	OK		
	Pan Mode	Activates the full scroll mode.	OK	OK		
	Cursor Mode	Activates the cursor mode.	OK	OK		
	Show Parameter Labels	Shows or hides parameter labels.	OK	OK	---	
	Show Parameter Value	Shows or hides parameter values.	OK	OK	---	
	Show Changes Only	Displays only parameters with modified values.	OK	OK		
	Show Differences Only	Displays only parameters with values different from the drive.	OK	OK		
	Show Invalids Only	Displays only parameters with invalid values.	OK	OK		
	Display Format	Changes to one of the following display formats: Normal, High Low Text, Orange LED, Red LED, Green LED, or Blue LED.	OK	OK	---	
Drive	Change	Edits the active drive properties.	OK	OK		
	Work Online	Connects to the drive.	OK	OK		
	Initialize	Initializes the parameters of the drive to the default values.	OK	OK		
	Password Protection	Sets the password for the drive.	OK	OK		
	Parameter Editor	Opens the parameter editor view for the current drive.	OK	OK		
	Select Parameter Graph	Opens the graphical editor containing the selected parameter.	OK	OK		
	Reset Selection	Resets the currently selected parameters.	OK	OK		
	Reset All	Resets all parameters.	OK	OK		
	Save To FROM (for Servo via MCH only)	Saves the parameters to the flash memory in the Servo via MCH.	---	OK		
	Transfer	To Drive	Downloads the complete parameter set to the drive.	OK	OK	
		From Drive	Uploads the complete parameter set from the drive.	OK	OK	
		Compare with Drive	Uploads the parameters of the drive in the Drive Value Column to enabling comparing the parameter set.	OK	OK	
		Selection To Drive	Downloads the selected parameters to the drive.	OK	OK	
		Selection From Drive	Uploads the selected parameters from the drive.	OK	OK	
	Alarms	Opens the drive alarm window showing the current alarms and alarm trace.	OK	OK		
No Module Detection Clear	Clears the A.E7 (No module detection) error.	---	OK	---		
Data Trace	Configures and activates the Servo data trace function.	---	OK			

Menu	Submenu/Command	Contents	Inverter	Servo	Icon
Drive	Real Time Trace	Displays the current values of the selected parameters.	OK	OK	
	FFT	Performs the FFT analysis.	---	OK	
	Test	Performs a test run.	OK	OK	
	Auto-Tune	Executes the auto-tuning function built into the drive.	OK	OK	
	Set Absolute Encoder	Configures a Servomotor absolute encoder.	---	OK	---
	Damping Control	Configures Servo damping control.	---	OK	---
	Adjust Offsets	Configures Servo offsets.	---	OK	---
	Product Information	Displays product information.	OK	OK	---
Tools	Database Upgrade	Upgrades the database to the latest version.	OK	OK	---
	Options	Sets CX-Drive options.	OK	OK	
	Calculator	Displays the Microsoft calculator.	OK	OK	
	Compare Drives	Displays the parameter differences between 2 drive files.	OK	OK	---
Window	Close All	Closes all open windows.	OK	OK	---
	Cascade	Arranges windows as overlapping files.	OK	OK	---
	Tile Horizontally	Arranges windows as horizontal, non-overlapping tiles.	OK	OK	---
	Tile Vertically	Arranges windows as vertical, non-overlapping tiles.	OK	OK	---
	Arrange Icons	Arranges the icons at the bottom of the window.	OK	OK	---
Help	Help Topics	Displays an index to topics on which help is available.	OK	OK	
	Help	Provides contextual help to provide help relating to the active window.	OK	OK	
	Online Registration	Registers your application on the OMRON website.	OK	OK	---
	Omron on the web	Opens the OMRON Corporate website.	OK	OK	---
	About CX-Drive	Displays the version number of the application.	OK	OK	

2-5 Editing Drive Files

1. Use the New Drive Dialog Box to set the drive name, drive type, connection type, and other information, or 2. Use **Autodetect** to select the target drive. The following window will be displayed.

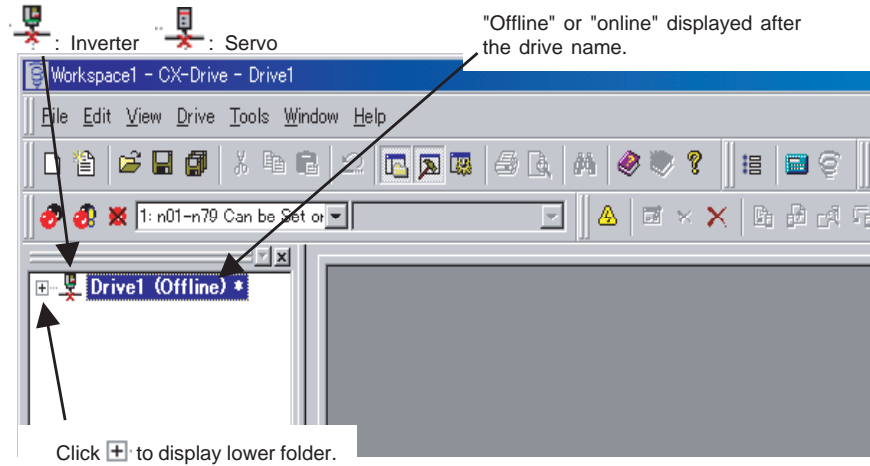

Click + at the left of the drive name to display the following tree.

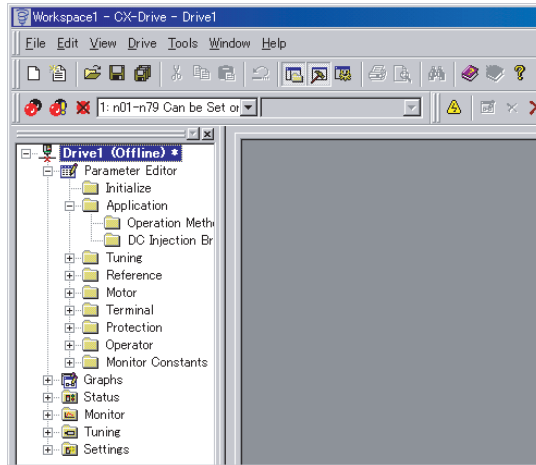

2-5-1 Editing Parameters

The parameters for each drive (an Inverter or Servo) can be edited under the parameter numbers.

Parameter Editor: Numeric Order

Double-click **Parameter Editor** to open the Parameter Editor Window in numeric order. Select and set each parameter.

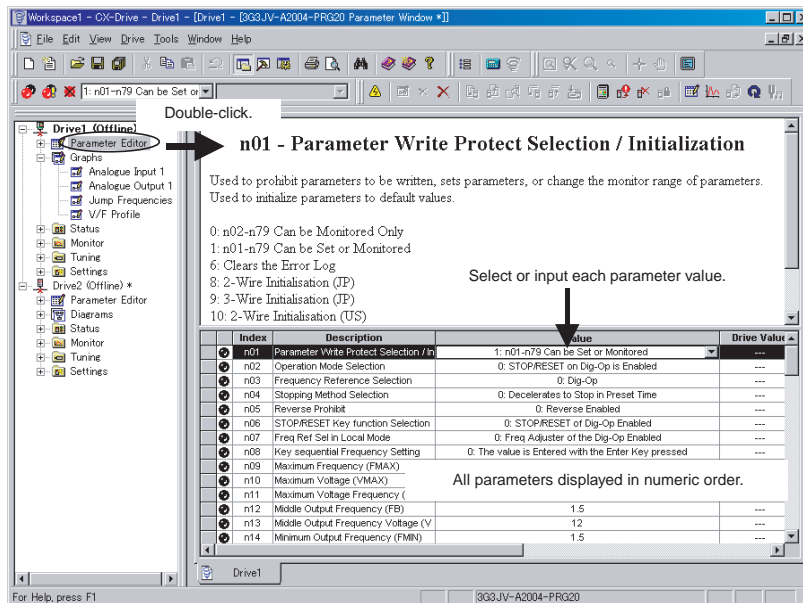

Parameter Editor in Functional Categories

Double-click the category folder to open the Categorized Parameter Editor Window. Select and set each parameter.

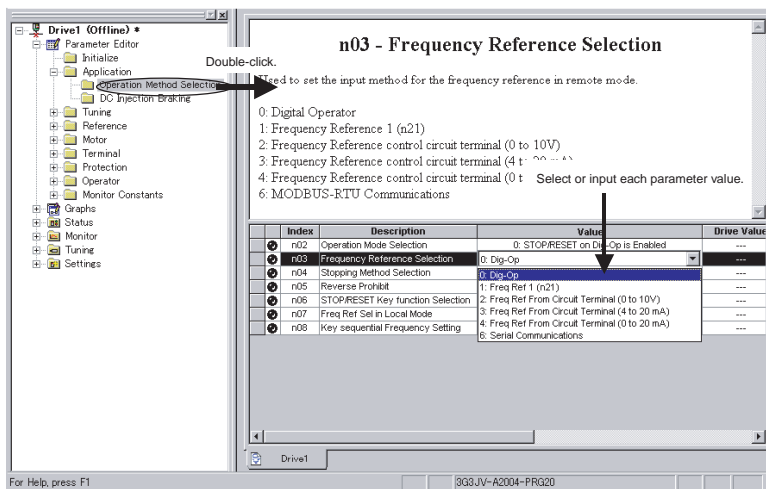

Comparing Drive and Parameter Data

The comparison operation uploads drive parameters without changing parameter values in the file data. The Parameter Editor Window shows both the drive file and the file data at the same time, and indicates the differences.

- ⚙️: Default, ⚙️: Default but different from the drive, ⚙️: Not default, ⚙️: Not default and different from the drive.
- ❌: Invalid, ❌: Invalid and different from the drive.

2-5-2 Graphs

Parameters can be displayed in graphic form for review (for Inverters only).

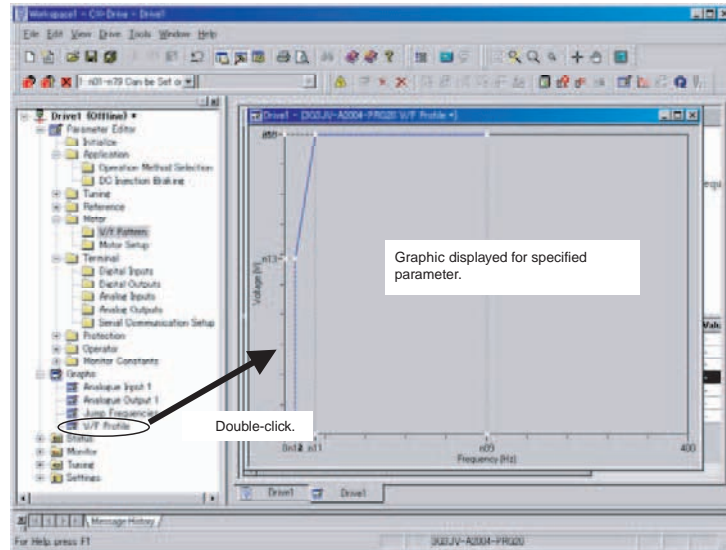

2-5-3 Diagrams

Parameters can be displayed in block diagrams for relevant parameters. Inverters support PID block diagrams, and Servos support position, speed and torque block diagrams.

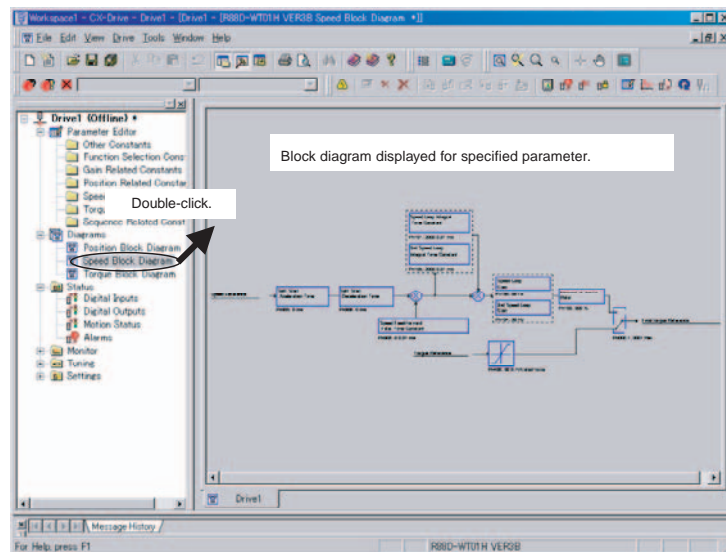

2-5-4 Status Displays

The status of the online drive can be displayed.

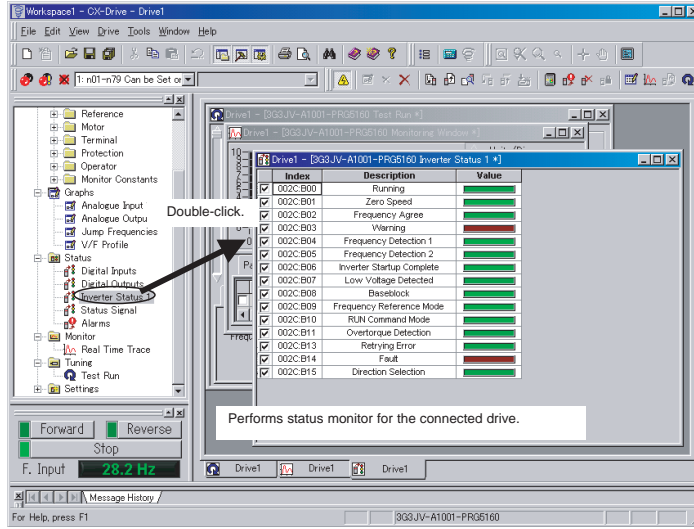

2-5-5 Monitoring

Realtime traces can be displayed for the selected parameters of the online drive. Data traces are also possible for the R7D-AP and R88D-WT Servos.

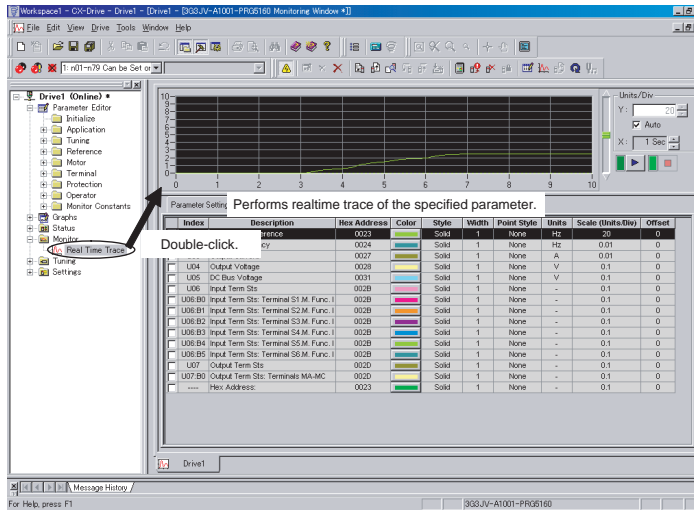

2-5-6 Data Trace

There is the Data Trace function to get Servo Drive Trace data in detail and show it and save it into the file. At the CX-Drive Version 1.6, there are some operation improvements such as graph area expanding, showing Vertical and Horizontal line cursors to measure the difference of two points of data (before V1.6, there are cross cursors), zoom in/out, both side vertical (Y axis) scale on the graph and saving the setting data with graphical data.

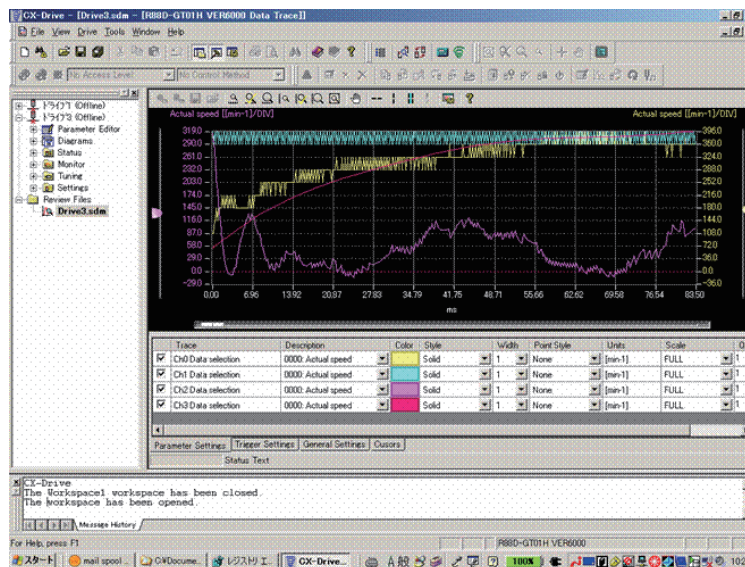

2-5-7 Auto Tune

With this function, you can automatically make gain adjustments so that the responsive to servo commands can satisfy the required performance of the machine.

Especially with the G5 Series (R88D-KT/R88D-KN), gain adjustments can be made automatically by simple operations according to the wizard.

When you select a mechanical system, make operation settings, and set completion conditions according to the wizard, the motor runs according to the settings and the optimum gain parameter values are automatically calculated.

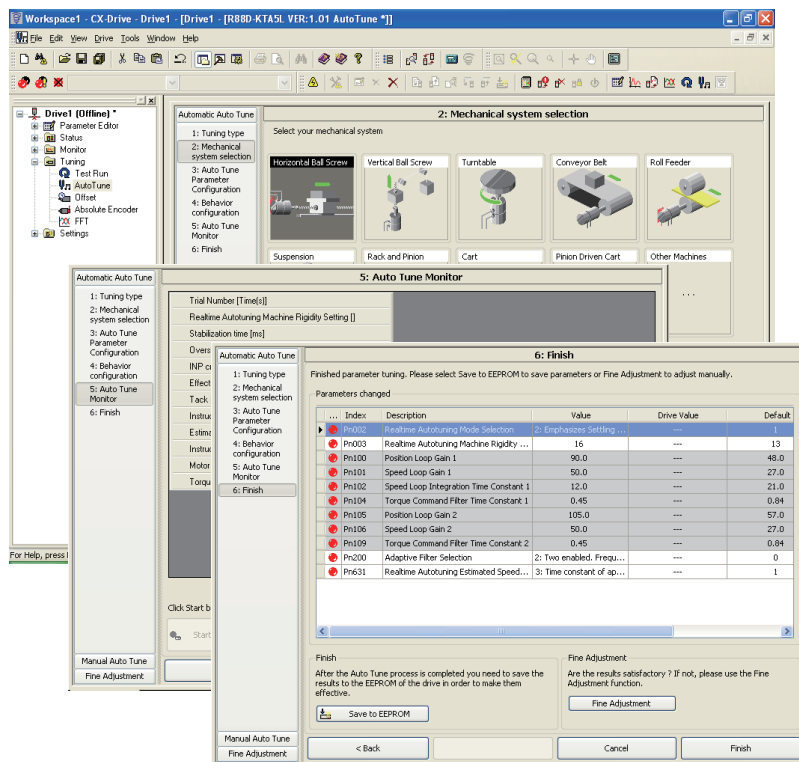

Note Enable the Test Run Mode to send a JOG command from CX-Drive during the execution of auto tune on the EtherCAT communications. Select **Drive - Drive Mode** from the main menu to enable the Test Run Mode.

When sending a JOG command from CX-Drive during the execution of auto tune on the USB communications, execute it when an EtherCAT or MECHATROLINK-II connection is not established.

2-5-8 Test Run

Test runs can be performed for the online drive. The frequency reference, jog speed, acceleration time, and deceleration time on the graph can be changed by entering values directly or by dragging handles.

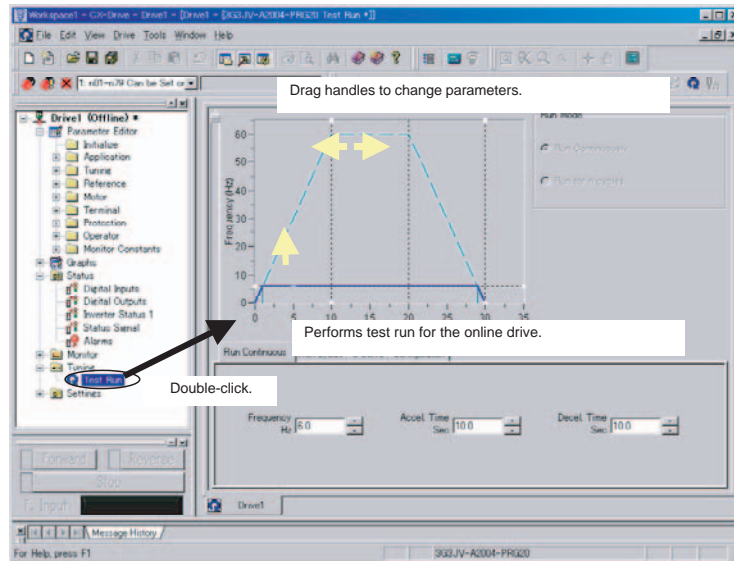

For Servos, auto-tuning, motor current detect offset adjustments, and absolute multi-turn limit settings are also supported.

Note Please execute this function when an EtherCAT or MECHATROLINK-II connection is not established.

Enable the Test Run Mode to execute this function on the EtherCAT communications. Select **Drive – Drive Mode** from the main menu to enable the Test Run Mode.

2-5-9 FFT

FFT analysis can be performed for the online drive.

The resonant frequency of the device can be specified by checking the gain of frequency response. This is effective when manually making the notch filter settings.

The response of the device can be verified by checking the phase of frequency response.

This is effective when adjusting the response of the device such as the integration time constant of velocity loop and velocity feedforward amount.

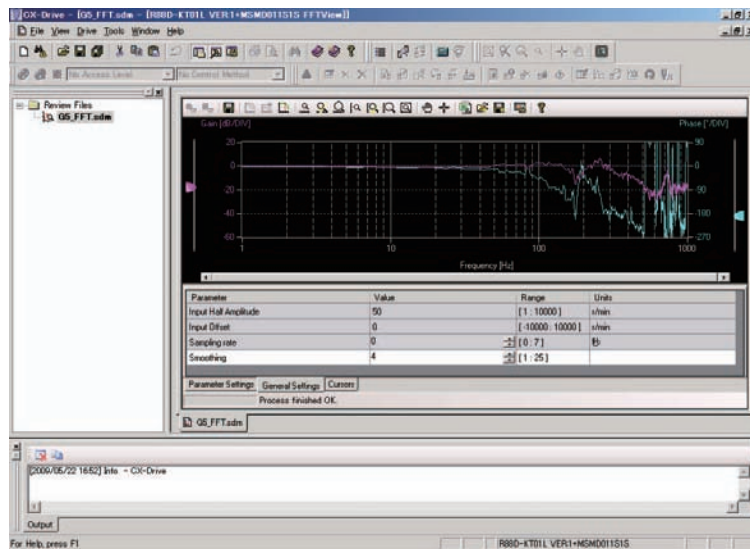

Note Please execute this function when an EtherCAT or MECHATROLINK-II connection is not established.

Enable the Test Run Mode to execute this function on the EtherCAT communications. Select **Drive – Drive Mode** from the main menu to enable the Test Run Mode.

2-5-10 Damping Control

When an end of the equipment vibrates or the entire device shakes, anti-vibration control can be used to remove the vibration frequency component from a position command.

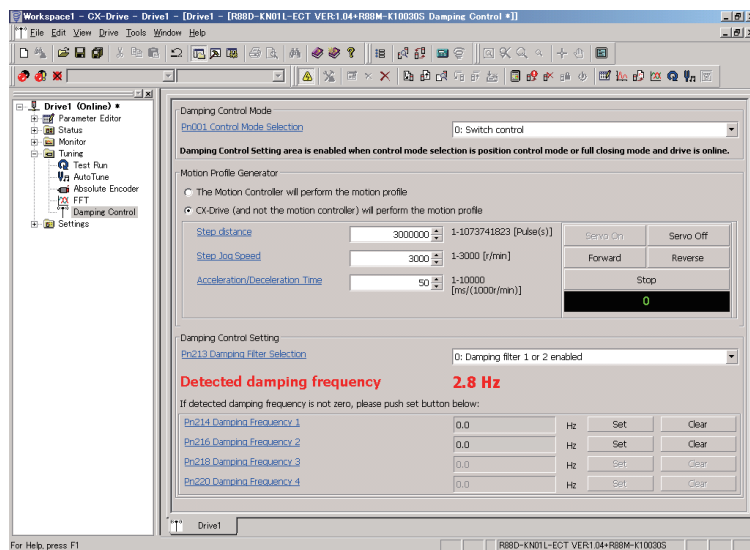

Note Enable the Test Run Mode to send a JOG command from CX-Drive during the execution of damping control on the EtherCAT communications. Select **Drive – Drive Mode** from the main menu to enable the Test Run Mode.

When sending a JOG command from CX-Drive during the execution of damping control on the USB communications, execute it when an EtherCAT or MECHATROLINK-II connection is not established.

2-5-11 Quick Parameter Setup

With the G5-series Servo Drive (R88D-KT/R88D-KN), you can set necessary parameters at startup by simple operations according to the wizard. Just after making a setting for installation environment, I/O signals, and other necessary items according to the wizard, you can start the Servo Drive adjustment.

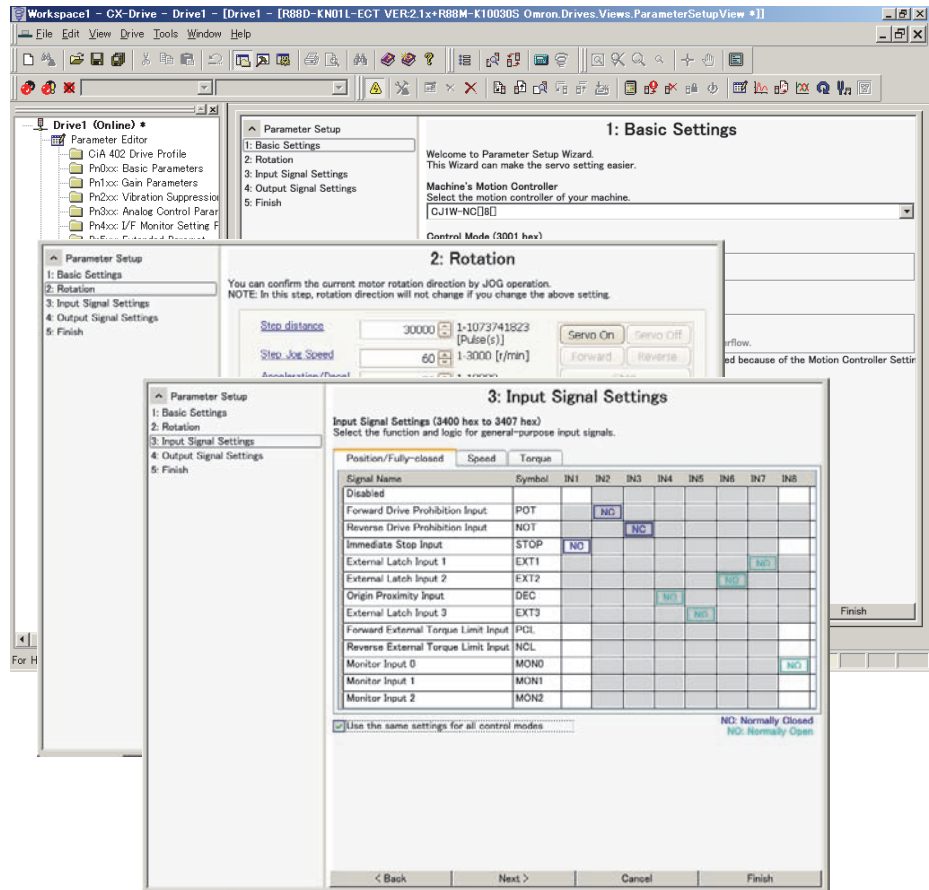

Note The Servo Drive must be free from errors to send a JOG command from CX-Drive in the quick parameter setup function. Therefore, I/O signals and other wiring may be required in advance.

2-5-12 Motor Setup

With the G5-series Servo Drive with Build-in EtherCAT Communications Linear Motor Type, you can set necessary parameters to move the linear motor by simple operations according to the wizard. Just after selecting the model of linear motor, doing Linear System Auto Setup, and other necessary items according to wizard, you can start the Servo Drive adjustment.

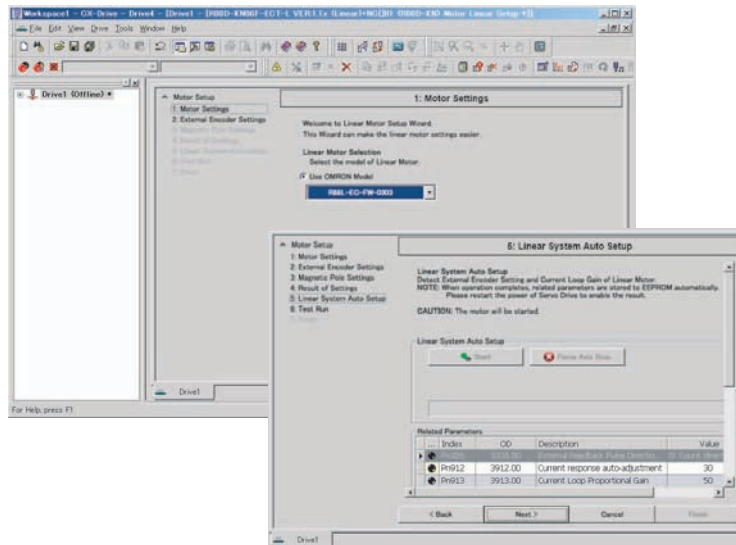

Note Enable the Test Run Mode during the execution of Motor Setup in linear motor setup on the EtherCAT communications. Select **Drive – Drive Mode** from the main menu to enable the Test Run Mode. When sending a JOG command from CX-Drive during the execution of linear motor setup on the USB communications, execute it when an EtherCAT connection is not established.

2-5-13 Settings

The parameters of the online drive can be initialized, and password authorization can be set for some drive models.

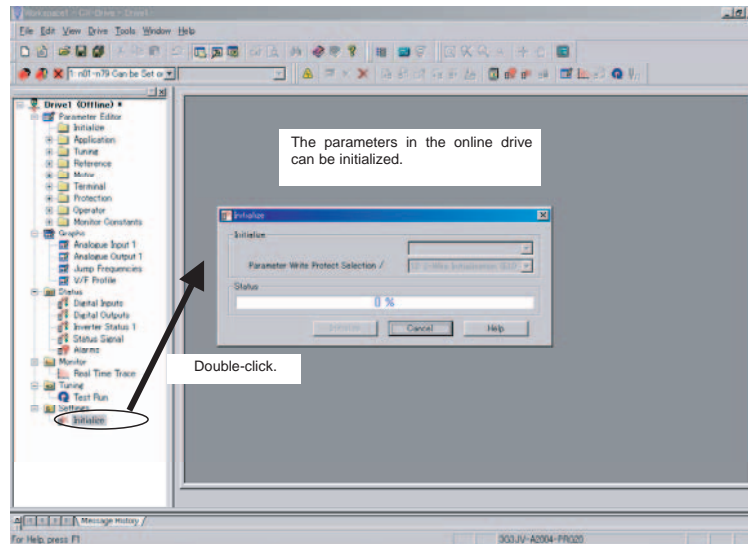

Also refer to the *CX-Drive Online Help* for operating procedures and functions. Select **Help** from the Help Menu or click the  Button to display context help, which displays help about the currently displayed window.

Revision History

A manual revision code appears as a suffix to the catalog number on the front cover of the manual.

Cat. No. W453-E1-21



The following table outlines the changes made to the manual during each revision. Page numbers refer to the previous version.

Revision code	Date	Revised content
01	November 2005	Original production
02	January 2006	Pages xvi and 9: Caution on the use of the USB serial converter added.
03	April 2006	Caution on the use of the USB serial converter revised and revisions for product version 1 accompanying upgrade to CX-Drive version 1.12 added.
04	July 2006	Corrections accompanying upgrade from CX-Drive version 1.12 to 1.3. (Specifications changed from absolute path information for all drive data files in the workspace (file name extension .sdw) to relative path information.)
05	June 2007	Corrections accompanying upgrade from CX-Drive version 1.3 to 1.4 (Windows Vista).
06	May 2008	Adding the support of OMNUC G series and SMARTSTEP2 series Direct serial connections. Changing the Data Trace function operation and GUI improvement.
07	July 2008	Adding the support of OMNUC G series R88D-GN Direct serial communications.
08	October 2008	Adding the support of 3G3JX/MX/RX.
09	March 2009	Adding the cable name for 3G3JX/MX/RX.
10	June 2009	Adding the support of OMNUC G5-series R88D-KT Direct USB connections. Adding the support of the FFT analysis function.
11	October 2009	Adding the support of 3G3MX2. Adding the support of R88D-KN (with Built-in MECHATROLINK-II Communications) Direct USB connections.
12	December 2009	Additions related to Windows 7.
13	February 2010	Adding the support of OMNUC G5-series R88D-KN (with Built-in EtherCAT Communications).
14	May 2010	Adding the support of the wizard function for auto tune.
15	July 2010	Adding the support of 3G3AX-MX2-ECT EtherCAT communications option board for 3G3MX2.
16	October 2010	Adding the support of 3G3AX-MX2-DRT DeviceNet communications option board for 3G3MX2.
17	January 2011	Adding the support of damping control.
18	May 2011	Adding the support of test run for 3G3MX2.
19	November 2011	Adding the support of 3G3RX-V1, 3G3AX-MX2-CRT-E CompoNet communications option board for 3G3MX2, 3G3AX-RX-DRT-E DeviceNet communications option board for 3G3RX, and 3G3AX-RX-CRT-E CompoNet communications option board for 3G3RX. Adding the support of quick parameter setup function for R88D-KT and R88D-KN.
20	April 2012	Adding the support of OMNUC G5-Series R88D-KN (with Built-in EtherCAT Communications Linear Motor Type). Adding the support of 3G3AX-RX-ECT EtherCAT communications option board for 3G3RX-V1.

Revision History

Revision code	Date	Revised content
21	June 2013	Adding the support of 3G3MX2-V1. Adding the motor models in Motor Setup function.

OMRON Corporation Industrial Automation Company
Tokyo, JAPAN

Contact: www.ia.omron.com

Regional Headquarters

OMRON EUROPE B.V.

Wegalaan 67-69-2132 JD Hoofddorp
The Netherlands
Tel: (31)2356-81-300/Fax: (31)2356-81-388

OMRON ELECTRONICS LLC

One Commerce Drive Schaumburg,
IL 60173-5302 U.S.A.
Tel: (1) 847-843-7900/Fax: (1) 847-843-7787

OMRON ASIA PACIFIC PTE. LTD.

No. 438A Alexandra Road # 05-05/08 (Lobby 2),
Alexandra Technopark,
Singapore 119967
Tel: (65) 6835-3011/Fax: (65) 6835-2711

OMRON (CHINA) CO., LTD.

Room 2211, Bank of China Tower,
200 Yin Cheng Zhong Road,
PuDong New Area, Shanghai, 200120, China
Tel: (86) 21-5037-2222/Fax: (86) 21-5037-2200

Authorized Distributor:

© OMRON Corporation 2005 All Rights Reserved.
In the interest of product improvement,
specifications are subject to change without notice.

Cat. No. W453-E1-21

0613

Below is a list of articles with direct links to our shop Electric Automation Network where you can see:

- Quote per purchase volume in real time.
- Online documentation and datasheets of all products.
- Estimated delivery time enquiry in real time.
- Logistics systems for the shipment of materials almost anywhere in the world.
- Purchasing management, order record and tracking of shipments.

To access the product, [click on the green button.](#)

Product	Code	Reference	Product link
	249035	SI-232/JC	Buy on EAN
	249034	SI-232/J	Buy on EAN
Drives, Optional Componet card (RXup)	355920	3G3AX-RX-CRT-E	Buy on EAN
Servos, Cable PC for programming and servos SS2 Series-G	292046	R88A-CCG002P2	Buy on EAN
Drives, Optional EtherCat card (RXup)	371931	3G3AX-RX-ECT	Buy on EAN
Drives, Card Optional Device Net (MX2)	329711	3G3AX-MX2-DRT-E	Buy on EAN
Servos, servo cable programming SmartStep	245304	R7A-CCA002P2	Buy on EAN
Drives, Card Optional Device Net (RXup)	355919	3G3AX-RX-DRT-E	Buy on EAN
	251861	SI-485/J	Buy on EAN
Drives, Optional Componet card (MX2)	335663	3G3AX-MX2-CRT-E	Buy on EAN
Drives, Optional EtherCat card (MX2)	343139	3G3AX-MX2-ECT	Buy on EAN