



Electric Automation
Automation specialists

Reference: RAAM 160 FT
Code: 6041950

Mounting/branch piece with quick connector, 110x600, Hot-dip galvanised, DIN EN ISO 1461, Steel, St

Buy it at [Electric Automation Network](#)

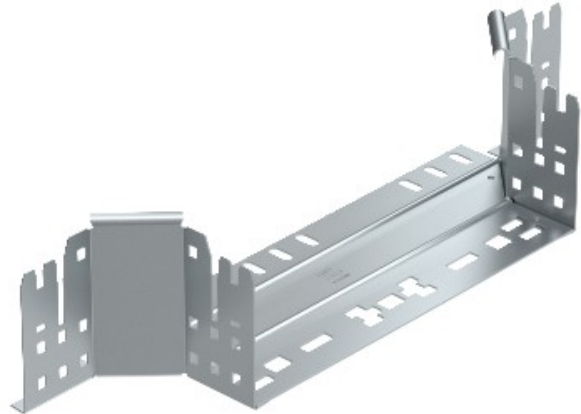

Mounting/branch piece with quick connector system. For all cable tray types of 110 mm side height.