



Electric Automation
Automation specialists

Reference: RAAM 120 FS
Code: 6041922

Mounting/branch piece with quick connector, 110x200, Strip-galvanised, DIN EN 10147, Steel, St

Buy it at [Electric Automation Network](#)

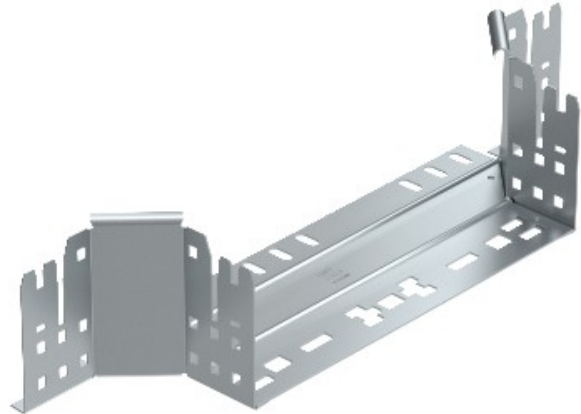

Mounting/branch piece with quick connector system. For all cable tray types of 110 mm side height.