



Electric Automation
Automation specialists

Reference: 2056N 58 FT

Code: 1163582

Clamp clip , 52-58mm, Hot-dip galvanised, DIN EN ISO 1461, Steel, St

Buy it at [Electric Automation Network](#)

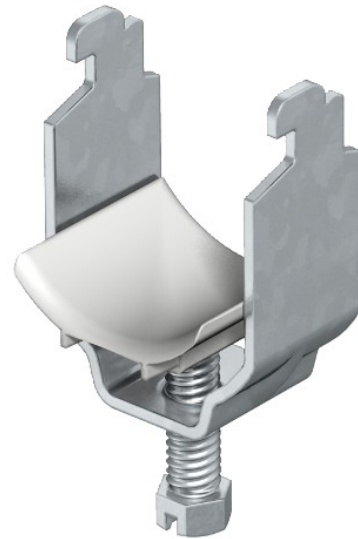

Suitable for all C profile rails with slot width > 50mm. Clip and bolt made of hot-dip galvanised steel.

Polypropylene pressure trough, halogen-free, colour light grey RAL 7035.