



Electric Automation
Automation specialists

Reference: JSM A13
Code: 2TLA040037R5100

JSM A13-1076 H-profile L=1076

Buy it at Electric Automation Network

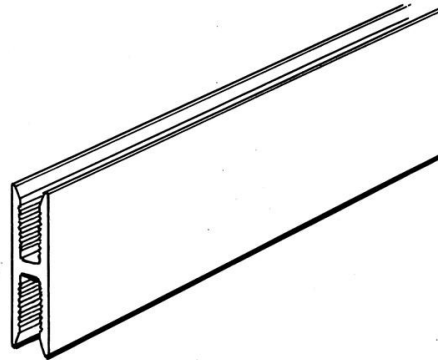

H-profile for Quick-Guard E. Natural anodized Aluminium. Length 1076mm

Ordering

EAN:	7350024462791
Minimum Order Quantity:	1 piece
Customs Tariff Number:	76109090

Dimensions

Product Net Width:	1.076 m
Product Net Height:	0.044 m
Product Net Depth:	0.0104 m
Product Net Weight:	0.508 kg

Container Information

Package Level 1 Units:	1 piece
Package Level 1 Gross Weight:	0.508 kg

Additional Information

Product Main Type:	Quick-Guard
Product Name:	Safety Fencing Systems Quick Guard

Certificates and Declarations (Document Number)

Data Sheet, Technical Information:	2TLC172001C0202_chapter13
------------------------------------	---------------------------

Declaration of Conformity - CE:	NoDecNee
---------------------------------	----------

Classifications

ETIM 4:	EC000386 - Support/Profile rail
ETIM 5:	EC000386 - Support/Profile rail
Object Classification Code:	U